

2024
2025
frenos



Abrazaderas y seguros cruceta	99	Partes para booster y flecha	98
Ajustadores para balata.....	88	Partes para dirección y alineación ..	259
Ajustes para clutch	104	Partes para caja de velocidades	247
Anclas y levas para zapata.....	68	Partes para clutch	101
Aspas para ventilador	233	Partes para clutch Volkswagen.....	103
Aumentos de bujía	254	Partes para freno	74
Bujes y baleros para flecha piloto ...	107	Partes para motor.....	250
Bujes y pernos para caliper.....	60	Partes para suspensión.....	249
Cuencas limpiaparabrisas y T de plastico...235		Partes para tambor.....	73
Cuencas y partes para clutch.....	100	Partes para Volkswagen	241
Juegos de herrajes para caliper.....	61	Pernos de puerta	236
Juego de clavos para zapata y chicotes..78		Pernos y partes para zapata.....	70
Juego de resortes para balata.....	80	Pistones para caliper	27
Juego de seguros para caliper.....	65	Purgadores para freno	77
Juegos varios	260	Purificadores de aire	239

Kits

Kits de caliper	108	Repuestos para caliper sin pistón	56
Kits de rueda delantera.....	227	Repuestos para palanca de velocidades	244
Kits para rueda trasera	230	Rieles para caliper.....	59
Kits para freno de tambor.....	197	Rondanas para mango.....	97

Miscelánea

Miscelánea	240	Seguros para caliper	62
Engranajes para velocímetro.....	238	Seguros para collarín.....	106
Llaves extractoras para filtros	252	Seguros para cubierta.....	93
Partes eléctricas	255	Seguros y tuercas para rueda	94
		Separadores para balata.....	72
		Tapones grasera para rueda.....	91
		Tapones y partes para carter.....	253
		Tornillos para caliper	57
		Varillas para clutch.....	105

TABLA DE CÓDIGOS



CÓDIGO	UXV	PÁG	CÓDIGO	UXV	PÁG	CÓDIGO	UXV	PÁG	CÓDIGO	UXV	PÁG
HO001H	1	241	HO075	2	78	HO129	2	79	HO194R	1	88
HO006H	2	99	HO076	2	78	HO132	2	101	HO195R	1	88
HO007H	2	99	HO076H	2	78	HO134A	2	94	HO196R	1	88
HO008H	2	99	HO077H	1	103	HO135	2	93	HO197	1	88
HO009H	2	99	HO077HA	1	103	HO140	2	78	HO199	1	88
HO010HA	2	68	HO079	2	97	HO141	2	78	HO2000	2	51
HO010HB	2	68	HO079A	2	97	HO141A	2	78	HO2001	2	51
HO011H	2	68	HO080	2	97	HO141B	2	78	HO2003	2	51
HO011HA	2	68	HO081A	2	93	HO141C	2	78	HO2004	2	51
HO012H	2	97	HO082	2	93	HO141D	2	78	HO2006	4	52
HO012HA	2	97	HO088H	2	61	HO141E	2	78	HO201	1	88
HO013H	2	97	HO089H	2	61	HO145	2	93	HO2012	2	52
HO014H	2	100	HO091H	1	247	HO146	2	97	HO2013	2	52
HO014HA	2	100	HO091HA	1	247	HO146A	2	97	HO2014	4	52
HO014HB	2	100	HO095	2	97	HO147	2	97	HO2015	8	52
HO014HC	2	100	HO096H	4	57	HO148	2	97	HO2016	8	52
HO017H	2	106	HO097HA	4	57	HO149	2	68	HO2017	2	52
HO018H	2	106	HO099H	4	57	HO149A	2	68	HO2018	2	52
HO018HA	1	106	HO099HA	4	57	HO149B	1	68	HO2019	2	52
HO018HB	1	106	HO099HM	4	57	HO149C	1	68	HO2020	2	52
HO018HC	2	106	HO100H	4	57	HO150	1	68	HO2021	2	52
HO018HD	1	106	HO100HA	4	57	HO151	1	68	HO2022	2	52
HO018HP	1	106	HO100HB	4	57	HO152	1	68	HO2023	2	53
HO019H	1	90	HO100HCTO	4	57	HO153	2	68	HO2024	8	53
HO019HJC	1	260	HO100HD	4	57	HO154	1	68	HO2025	8	53
HO019HJL	1	260	HO100HE	4	57	HO155	2	94	HO2026	2	53
HO020H	4	61	HO100HF	4	57	HO156	2	94	HO203	2	88
HO020HB	2	62	HO101HB	2	57	HO156A	2	94	HO205	1	88
HO023H	2	100	HO101HC	4	58	HO156B	2	94	HO205A	1	88
HO024H	2	100	HO102	4	58	HO157	2	79	HO205J	2	65
HO025H	1	249	HO102B	4	58	HO158	2	79	HO206J	2	65
HO026H	1	249	HO102C	4	58	HO159	1	79	HO207	2	43
HO027H	2	97	HO102CTO	4	58	HO160	1	79	HO207A	2	43
HO028H	2	97	HO102E	4	58	HO162	2	88	HO207B	2	43
HO029H	2	97	HO102J	2	65	HO162AR	1	88	HO207C	2	43
HO031	5	101	HO102L	4	58	HO163	2	88	HO207CA	2	43
HO034H	1	247	HO103A	4	61	HO164	2	101	HO207CB	2	43
HO034HA	2	247	HO103B	4	61	HO165	2	59	HO207D	4	43
HO044H	2	100	HO103C	4	58	HO165A	2	72	HO207E	2	43
HO045H	2	100	HO103D	4	58	HO165B	2	72	HO207F	2	43
HO047	2	97	HO103E	4	58	HO166AL	1	68	HO207G	4	44
HO047T	2	97	HO103F	4	58	HO166AR	1	68	HO207H	2	44
HO048	2	97	HO104	2	93	HO166L	1	68	HO207I	4	44
HO048A	2	97	HO106	1	104	HO166R	1	68	HO207J	2	44
HO048B	2	97	HO106J	1	260	HO167	2	94	HO207K	2	44
HO050	5	259	HO106JS	2	65	HO172A	16	250	HO207L	2	44
HO050A	5	259	HO107	1	104	HO173	2	99	HO207M	2	44
HO050B	5	259	HO108	1	104	HO174	2	73	HO207N	4	44
HO050C	5	259	HO112	1	105	HO176	2	94	HO207P	2	44
HO051H	2	59	HO112A	1	105	HO178	2	79	HO207R	2	44
HO051HA	2	59	HO113	1	105	HO178A	2	79	HO207S	2	44
HO052H	2	59	HO114	1	105	HO180	2	79	HO207T	4	44
HO052HA	2	59	HO114A	1	105	HO181	2	97	HO207TC	4	50
HO052HB	2	59	HO117	2	70	HO182H	2	62	HO207TG	4	50
HO052HC	2	59	HO117A	2	70	HO183	2	62	HO207U	2	45
HO052HE	2	59	HO117B	2	70	HO183A	2	62	HO207W	2	45
HO052HF	2	59	HO117C	2	70	HO184	2	62	HO207X	2	45
HO059	2	73	HO117D	2	70	HO184A	2	62	HO207Z	1	45
HO060	2	73	HO117E	2	70	HO184B	2	62	HO208	4	37
HO061	2	73	HO118AL	1	72	HO184C	2	62	HO208A	4	37
HO062	2	73	HO118AR	1	72	HO185	2	61	HO208B	4	37
HO066H	1	249	HO125	2	93	HO186A	2	62	HO208C	4	37
HO067H	1	249	HO126	2	99	HO186B	2	62	HO208D	2	37
HO072	2	78	HO126A	2	99	HO19338	1	102	HO208E	4	38
HO073	2	78	HO126B	2	99	HO193716	1	102	HO208F	4	38
HO074	2	78	HO128	2	78	HO193A	1	101	HO208G	4	38

*UxV= UNIDADES POR VEHÍCULO

TABLA DE CÓDIGOS

CÓDIGO	UXV	PÁG	CÓDIGO	UXV	PÁG	CÓDIGO	UXV	PÁG	CÓDIGO	UXV	PÁG
HO208H	4	38	HO211A	2	27	HO213Z	4	37	HO2302	2	50
HO208I	2	38	HO211B	2	27	HO214	2	53	HO231J	2	65
HO208J	4	38	HO211C	2	27	HO214A	2	53	HO233	4	61
HO208K	4	38	HO211D	2	27	HO214B	2	53	HO233J	2	65
HO208L	4	38	HO211E	4	27	HO214C	2	53	HO234	4	61
HO208M	4	38	HO211F	2	48	HO214D	2	53	HO235	2	73
HO208N	2	38	HO211G	2	27	HO214E	2	53	HO236	2	88
HO208P	2	38	HO211H	4	27	HO214F	2	53	HO238	4	59
HO208R	2	38	HO211I	4	27	HO214G	2	53	HO240	2	62
HO208S	4	39	HO211J	2	27	HO214H	4	54	HO2400	2	45
HO208T	4	39	HO211K	4	27	HO214K	4	54	HO2400A	4	45
HO208U	2	39	HO211L	2	27	HO214L	2	54	HO2401	4	45
HO209	2	32	HO211M	2	28	HO215	2	41	HO2402	4	45
HO209A	2	49	HO211N	2	28	HO216	2	28	HO2403	2	45
HO209B	2	51	HO211P	4	28	HO216A	2	28	HO2404	2	45
HO209C	2	46	HO211R	4	28	HO216B	2	29	HO2405	2	45
HO209D	2	46	HO211S	2	28	HO216C	2	29	HO2406	4	45
HO209E	2	49	HO211T	4	28	HO216D	2	29	HO2407	4	46
HO209F	2	49	HO211U	2	28	HO216E	2	29	HO2408	2	46
HO209G	2	46	HO211W	4	28	HO216F	2	29	HO2409	2	46
HO209H	2	51	HO211X	4	28	HO216G	4	31	HO240A	2	62
HO209I	2	51	HO211Z	2	28	HO216H	4	31	HO240B	2	62
HO209J	2	51	HO212	2	32	HO216I	2	31	HO240J	2	65
HO209K	2	51	HO212A	2	32	HO216J	2	31	HO2410	2	46
HO209L	2	51	HO212B	2	32	HO216K	2	31	HO2411	4	46
HO209M	2	49	HO212C	2	33	HO216L	4	31	HO2412	2	46
HO209N	2	49	HO212D	2	33	HO216M	2	31	HO241A	2	62
HO209P	2	49	HO212E	2	48	HO216N	2	31	HO241B	4	62
HO209R	2	46	HO212F	2	33	HO216P	2	31	HO241C	4	62
HO209S	2	51	HO212G	2	33	HO216R	4	31	HO241D	2	62
HO209T	2	46	HO212H	2	48	HO216S	4	32	HO241E	2	62
HO209U	2	51	HO212I	4	33	HO216T	2	32	HO245	2	63
HO209W	2	49	HO212J	2	33	HO216U	2	32	HO246	2	88
HO209X	2	49	HO212K	2	33	HO216W	4	32	HO248	1	88
HO209Z	2	46	HO212L	2	48	HO216X	2	32	HO248A	2	88
HO210	2	39	HO212M	2	33	HO216Z	2	32	HO250	1	88
HO2100	2	47	HO212N	4	33	HO217	2	41	HO2502	2	48
HO2102	2	47	HO212P	2	33	HO217A	2	41	HO2503	2	29
HO2105	2	47	HO212R	2	33	HO217B	2	41	HO2504	4	29
HO2108	2	47	HO212S	4	33	HO217C	2	41	HO2505	2	29
HO2109	2	47	HO212T	2	34	HO217D	2	41	HO2506	2	29
HO210A	2	39	HO212U	2	34	HO217E	2	41	HO2507	2	29
HO210B	2	39	HO212W	2	34	HO217F	4	32	HO2508	4	49
HO210C	4	39	HO212X	2	34	HO217H	2	32	HO2508A	4	49
HO210D	2	39	HO212Z	4	34	HO217I	2	41	HO2509	4	29
HO210F	4	39	HO213	2	34	HO217J	2	41	HO250AR	1	88
HO210G	4	39	HO213A	2	34	HO217K	4	41	HO251	2	89
HO210H	4	39	HO213B	2	34	HO217L	4	41	HO2510	2	29
HO210I	2	39	HO213C	2	34	HO217M	4	41	HO2511	4	30
HO210J	2	40	HO213D	2	34	HO217N	2	42	HO2512	4	30
HO210K	4	40	HO213E	2	34	HO217S	4	42	HO2513	2	30
HO210L	2	40	HO213F	2	36	HO217T	2	42	HO2514	2	30
HO210M	2	40	HO213G	2	36	HO217U	4	42	HO2515	2	30
HO210N	2	40	HO213H	2	36	HO217W	2	42	HO2517	2	30
HO210P	2	40	HO213I	4	36	HO217Z	2	42	HO2518	2	30
HO210R	2	40	HO213J	2	36	HO218	1	107	HO2519	4	49
HO210S	4	40	HO213K	2	36	HO219	1	107	HO252	4	74
HO210T	2	40	HO213L	2	36	HO2200	2	48	HO2520	4	30
HO210W	4	40	HO213M	2	36	HO221	1	107	HO2521	2	30
HO210X	2	40	HO213N	4	36	HO222	1	107	HO2522	2	30
HO210Z	4	40	HO213P	8	37	HO223	1	107	HO2523	1	30
HO211	2	27	HO213R	4	37	HO224	1	107	HO2524	1	30
HO2110	2	47	HO213S	2	37	HO225J	2	65	HO2525	2	31
HO2111	2	47	HO213T	2	37	HO226	1	107	HO2527	2	31
HO2112	4	47	HO213U	4	37	HO230	2	94	HO252A	2	74
HO2113	2	47	HO213W	4	37	HO2300	2	50	HO252B	2	74

TABLA DE CÓDIGOS



CÓDIGO	UXV	PÁG	CÓDIGO	UXV	PÁG	CÓDIGO	UXV	PÁG	CÓDIGO	UXV	PÁG
HO253	2	70	HO280	2	94	HO3111	4	35	HO361	5	76
HO253A	2	70	HO2800	4	49	HO3112	4	35	HO362	2	71
HO253B	2	70	HO281	2	94	HO3113	2	36	HO363A	2	71
HO253C	2	70	HO281A	2	94	HO3114	4	36	HO364	4	73
HO253D	2	70	HO281T	2	94	HO3115	2	36	HO365	2	64
HO253E	2	70	HO282	2	94	HO312	4	63	HO366	2	64
HO253F	2	70	HO282A	2	94	HO312A	4	63	HO369	2	64
HO253G	2	70	HO283	2	94	HO313	4	57	HO371	2	64
HO253H	2	70	HO284	2	94	HO313A	4	57	HO372	2	64
HO253J	2	71	HO284A	2	94	HO313J	2	65	HO373	2	64
HO253K	2	71	HO285	2	94	HO314	2	63	HO374	2	64
HO253L	2	71	HO286	2	94	HO314A	2	63	HO376	1	99
HO254	1	89	HO287	2	94	HO314B	2	63	HO377	2	97
HO254AR	1	89	HO288	2	94	HO315	2	63	HO378	2	95
HO256A	4	60	HO289	2	95	HO316J	2	65	HO379	2	79
HO256B	4	60	HO289A	2	95	HO317	2	89	HO380	2	79
HO256C	4	60	HO289T	2	95	HO319	2	95	HO381	2	64
HO259	2	91	HO290	2	95	HO320	2	95	HO382	2	64
HO260A	2	91	HO2900	2	50	HO3200	4	42	HO384	2	91
HO260B	2	91	HO2901	1	50	HO3201	2	42	HO386	2	106
HO261	2	91	HO2902	1	50	HO3202	2	42	HO387	2	106
HO261B	2	91	HO2903	2	50	HO3203	4	42	HO388	2	95
HO262	2	91	HO2904	2	50	HO3204	2	42	HO389	2	92
HO262T	2	91	HO291	2	95	HO3205	2	42	HO390	2	92
HO263	2	91	HO292	2	95	HO3206	4	43	HO390A	2	92
HO264	2	91	HO292T	2	95	HO3207	2	43	HO391	2	73
HO264T	2	91	HO293	2	95	HO320J	2	65	HO392	2	92
HO265	2	91	HO294	2	95	HO321	2	95	HO392A	2	92
HO265T	2	91	HO294E	2	95	HO322	2	60	HO393	2	95
HO266	2	91	HO295	2	95	HO323	2	60	HO393B	2	92
HO266T	2	91	HO296	4	75	HO324	2	63	HO393C	2	92
HO267	2	91	HO296A	4	75	HO324A	2	63	HO393J	2	92
HO267A	2	91	HO296O	4	75	HO325	4	63	HO394	2	96
HO269T	2	91	HO297	4	75	HO326	4	58	HO395	2	96
HO2700	2	50	HO298	2	75	HO326A	4	58	HO396	2	96
HO2701	2	50	HO299	2	95	HO327	4	63	HO397A	2	96
HO2702	2	50	HO299A	2	95	HO328	4	63	HO397B	2	96
HO273	2	74	HO299K	2	95	HO329	2	89	HO399	2	106
HO273A	2	74	HO299M	2	95	HO330	2	71	HO399J	2	66
HO273B	2	74	HO300	2	63	HO3300	2	43	HO400L	1	89
HO273C	2	74	HO300A	2	63	HO330A	2	71	HO401J	1	66
HO273D	2	74	HO300J	2	65	HO331	2	72	HO402R	1	89
HO273E	2	74	HO301	1	75	HO332	2	72	HO403L	1	89
HO273F	2	74	HO302	4	63	HO333	2	89	HO406L	2	89
HO273G	2	74	HO303	2	76	HO335	2	64	HO409	2	64
HO273H	2	74	HO304	4	59	HO336	2	58	HO411J	2	66
HO273I	2	74	HO304A	2	63	HO337	2	64	HO412AL	1	89
HO273J	3	74	HO305	2	63	HO338	2	64	HO412L	1	89
HO273K	2	74	HO306	2	71	HO338J	2	65	HO414J	2	66
HO273L	2	75	HO306A	2	71	HO339	4	64	HO414L	1	90
HO273M	3	75	HO306B	2	71	HO340	4	58	HO416L	1	90
HO273N	4	75	HO306C	2	71	HO341	2	91	HO418R	1	90
HO273P	2	75	HO307	2	63	HO344	2	72	HO420L	1	73
HO273R	4	75	HO310	1	68	HO345	2	106	HO420R	1	73
HO273S	2	75	HO3100	4	34	HO346	2	89	HO429A	1	90
HO273T	2	75	HO3101	4	35	HO349	2	91	HO429L	1	90
HO274	2	75	HO3102	4	35	HO350	2	64	HO431L	1	90
HO274A	2	75	HO3103	4	35	HO351L	1	69	HO434L	1	90
HO275	2	71	HO3104	1	35	HO351R	1	69	HO436L	1	90
HO275A	2	71	HO3105	4	35	HO352L	1	73	HO438L	1	72
HO275B	2	71	HO3106	2	35	HO352R	1	73	HO438R	1	72
HO276	2	89	HO3107	2	35	HO353	4	58	HO439L	1	72
HO276A	1	89	HO3108	4	35	HO354	4	58	HO439R	1	72
HO276B	1	89	HO3109	2	35	HO355	4	97	HO445R	1	90
HO278	1	89	HO310A	1	69	HO357	4	60	HO446L	1	72
HO278A	1	89	HO3110	4	35	HO358	1	107	HO446R	1	72

*Uxv= UNIDADES POR VEHÍCULO

TABLA DE CÓDIGOS

CÓDIGO	UXV	PÁG	CÓDIGO	UXV	PÁG	CÓDIGO	UXV	PÁG	CÓDIGO	UXV	PÁG
HO447L	1	72	HO516H	1	239	HO569A	4	236	HO620A	1	242
HO447R	1	72	HO517	2	98	HO570	1	250	HO620J	2	67
HO448	2	72	HO518	2	98	HO572	1	250	HO621	4	236
HO449	2	72	HO518J	2	66	HO575	1	241	HO622	4	237
HO450	2	72	HO519	2	98	HO576	1	241	HO623	4	237
HO450A	2	72	HO519J	2	66	HO577	2	235	HO624	2	98
HO451	2	72	HO520	2	249	HO578	2	235	HO624A	2	98
HO452	2	72	HO520B	2	249	HO580	2	249	HO625	2	98
HO452AL	1	72	HO520C	2	249	HO582	1	241	HO625A	2	98
HO452AR	1	72	HO520F	2	241	HO584	2	249	HO626	1	242
HO454R	1	90	HO520F	2	249	HO585	1	249	HO627	2	256
HO461	2	92	HO520G	2	241	HO587	1	249	HO627C	2	256
HO461A	2	92	HO520H	2	241	HO588	1	241	HO628	2	256
HO463A	1	90	HO520J	2	66	HO589	1	241	HO628C	2	256
HO465A	1	255	HO520K	2	241	HO590	1	239	HO629	1	103
HO466	1	240	HO520S	1	249	HO591	1	239	HO633	2	235
HO467	1	101	HO521	2	255	HO592	2	249	HO633AJ	2	67
HO468	1	101	HO522	2	255	HO594A	1	103	HO635	1	242
HO469	1	244	HO524	2	255	HO594B	1	101	HO636	4	237
HO470	1	259	HO525	2	255	HO594T	1	101	HO637A	1	253
HO471	1	259	HO525B	2	255	HO595	1	252	HO638	2	242
HO472	1	259	HO525C	2	255	HO595A	1	252	HO639	1	256
HO473	1	101	HO525D	2	255	HO595B	1	252	HO641	1	250
HO475	1	240	HO525E	2	255	HO595C	1	252	HO641J	2	67
HO486	1	101	HO525G	2	255	HO595D	1	252	HO642	1	242
HO491	1	105	HO525H	2	255	HO595E	1	252	HO644	1	250
HO492	1	105	HO525I	2	255	HO595F	1	252	HO647	1	256
HO492A	1	105	HO525J	2	255	HO595G	1	252	HO647J	1	260
HO492R	1	90	HO526	1	253	HO596	1	239	HO649	1	80
HO493R	1	90	HO526J	2	260	HO597	1	244	HO650	1	256
HO498	2	92	HO527	2	256	HO598	1	244	HO650J	1	260
HO500	4	60	HO528J	2	66	HO598C	1	244	HO651	1	256
HO500A	4	60	HO529	4	236	HO599	1	244	HO652N	1	249
HO500B	4	60	HO530	4	236	HO599A	1	244	HO653N	1	249
HO500C	4	60	HO530A	4	236	HO599C	1	244	HO655	1	256
HO500E	4	60	HO530B	4	236	HO599J	1	244	HO656	1	256
HO503A	1	240	HO532	4	236	HO599M	1	244	HO657	1	242
HO503B	1	240	HO533	4	236	HO600	1	244	HO659	1	242
HO503C	1	240	HO533A	4	236	HO600J	2	66	HO659J	1	260
HO503J	2	66	HO534	4	236	HO601	1	244	HO660	2	103
HO504	1	103	HO535	4	236	HO601J	2	66	HO663	1	233
HO505	1	241	HO536	4	236	HO602	1	244	HO665	2	233
HO505A	1	241	HO537	4	236	HO602J	2	67	HO666	2	235
HO506	2	255	HO538	4	236	HO603	1	244	HO667	2	235
HO507	2	255	HO538A	4	236	HO603C	1	244	HO668	1	101
HO507A	2	255	HO538B	4	236	HO604	2	72	HO671	1	242
HO507J	2	66	HO538C	4	236	HO604BJ	2	67	HO672	1	103
HO508	2	255	HO539	1	253	HO604CJ	2	67	HO672A	1	103
HO509	2	255	HO540	1	253	HO604J	2	67	HO674	1	242
HO510	2	255	HO541	4	236	HO605	2	241	HO677A	1	242
HO511	2	255	HO542	4	253	HO606N	1	241	HO677B	1	242
HO512	2	247	HO543	1	253	HO607	1	241	HO678	2	256
HO512J	2	66	HO544	4	253	HO608	1	241	HO678A	2	256
HO513	8	253	HO545	4	253	HO609	1	241	HO678N	2	256
HO513A	6	253	HO545E	1	253	HO610	1	241	HO679	2	258
HO513B	6	253	HO547	4	253	HO611	1	244	HO679A	2	258
HO513J	2	66	HO547A	1	253	HO612	1	244	HO680	4	76
HO514	6	253	HO548	4	253	HO613	1	244	HO680A	4	76
HO515	1	239	HO549	4	253	HO614	1	244	HO681	4	76
HO516A	1	239	HO550	4	253	HO614A	1	245	HO681A	4	76
HO516B	1	239	HO553	4	250	HO614B	1	245	HO682	4	76
HO516C	1	239	HO554	4	250	HO615	1	250	HO682A	4	76
HO516D	1	239	HO555	16	250	HO616	1	241	HO682B	4	76
HO516E	1	239	HO556	16	250	HO618	2	256	HO682C	4	76
HO516F	1	239	HO567	16	250	HO619	2	256	HO682D	4	76
HO516G	1	239	HO568	4	253	HO620	1	241	HO683	4	76

TABLA DE CÓDIGOS



CÓDIGO	UXV	PÁG	CÓDIGO	UXV	PÁG	CÓDIGO	UXV	PÁG	CÓDIGO	UXV	PÁG
HO684	4	76	HO741	1	233	HO788	1	103	HO836	1	259
HO685	1	101	HO743	2	76	HO790	1	234	HO837C	1	246
HO686	2	101	HO744	1	257	HO791	1	234	HO839	1	246
HO687	1	250	HO746	1	233	HO792	1	103	HO840	1	246
HO687A	1	250	HO746A	1	233	HO793	1	234	HO840A	1	246
HO688	1	256	HO746B	1	233	HO794	1	234	HO841	2	96
HO689	1	101	HO746C	1	233	HO794A	1	234	HO842	2	96
HO691	1	247	HO747	1	233	HO795	1	234	HO843	2	96
HO692	1	103	HO748	1	253	HO795A	1	234	HO845	2	96
HO693	1	79	HO749	1	233	HO797	1	242	HO847	4	240
HO694	2	235	HO750	1	107	HO798A	1	234	HO847A	4	240
HO695	2	249	HO7500	2	47	HO799	1	234	HO847B	4	240
HO696	2	249	HO750A	1	107	HO800A	1	238	HO847C	4	240
HO699	1	247	HO750B	1	107	HO801C	1	238	HO848	2	96
HO699A	1	247	HO750C	1	107	HO801D	1	238	HO849	2	96
HO700	1	245	HO750D	1	107	HO801E	1	238	HO850	2	96
HO701	1	247	HO750E	1	107	HO801F	1	238	HO851	2	96
HO702	2	256	HO750F	1	107	HO801G	1	238	HO852	1	102
HO703	1	247	HO750G	1	107	HO803	1	253	HO852A	1	102
HO704	1	247	HO751	1	257	HO804	1	253	HO853	4	237
HO705	2	101	HO752S	1	257	HO805	1	245	HO854	4	237
HO705N	2	101	HO753	1	257	HO806	1	245	HO857	4	237
HO706	1	247	HO753A	1	257	HO807	1	245	HO857A	4	237
HO70600	2	54	HO755	2	101	HO807J	1	67	HO857B	4	237
HO70602	2	54	HO755A	2	101	HO808	1	248	HO857C	4	237
HO70603	2	54	HO756	2	102	HO808A	1	248	HO858A	4	237
HO70604	2	54	HO757	2	258	HO808J	1	248	HO858B	4	237
HO70605	2	54	HO757A	2	258	HO808P	1	248	HO858C	4	237
HO70606	2	54	HO757B	2	258	HO808S	1	248	HO859A	4	237
HO70607	2	54	HO757C	2	258	HO809	1	248	HO862	1	98
HO70608	2	54	HO758	4	254	HO810A	1	245	HO863	4	243
HO70609	2	54	HO758A	4	254	HO810B	1	246	HO864	1	98
HO70610	2	55	HO759	4	254	HO810C	1	245	HO864A	1	98
HO70611	2	55	HO760	4	254	HO810D	1	248	HO864AJ	1	260
HO70612	2	55	HO761	4	254	HO810Z	1	245	HO864B	1	98
HO707	1	247	HO762	1	257	HO811	1	248	HO864C	1	98
HO708	1	247	HO762A	2	257	HO812	4	254	HO864D	1	98
HO70800	2	55	HO763	1	257	HO812P	1	248	HO864J	1	260
HO709	1	242	HO765	1	257	HO813	1	249	HO865A	1	240
HO70900	2	55	HO766	1	257	HO814	1	102	HO866	1	240
HO710	1	245	HO767	1	257	HO815	1	242	HO867	1	240
HO711	1	242	HO768	1	257	HO815A	1	242	HO868	1	240
HO712	1	242	HO769J	1	260	HO816	1	103	HO869	1	240
HO713	1	245	HO771	4	257	HO817	1	240	HO870	1	250
HO714	1	245	HO772	1	233	HO818	1	240	HO871	2	98
HO715	1	245	HO774	1	233	HO819	2	96	HO872	2	98
HO715C	1	247	HO774A	1	233	HO820	4	237	HO873	2	235
HO715P	1	247	HO776	1	233	HO821	1	253	HO875	2	235
HO716	1	235	HO777	1	233	HO822	1	242	HO876R	1	90
HO717	1	245	HO777A	1	233	HO823	2	242	HO877	1	259
HO717R	1	245	HO778	1	245	HO824	1	245	HO878	1	253
HO721	2	256	HO779	1	245	HO825	2	64	HO879R	1	90
HO722	2	256	HO780	1	259	HO826	1	250	HO883	1	238
HO725	1	257	HO781	1	233	HO827	2	64	HO885	2	235
HO725J	1	260	HO781A	1	234	HO830	4	237	HO886	2	235
HO726	2	257	HO782	1	234	HO831	4	237	HO888	4	257
HO727	2	257	HO782A	1	234	HO832	4	237	HO889	4	257
HO728	2	98	HO783	1	234	HO833	4	237	HO890	1	102
HO730A	1	250	HO783A	1	234	HO834	1	259	HO891	1	102
HO735	2	240	HO784	1	234	HO834A	1	259	HO892	1	246
HO735A	2	240	HO785	1	102	HO834B	1	259	HO893	1	257
HO735C	2	240	HO785A	2	102	HO834C	1	259	HO893A	1	258
HO735D	2	240	HO786	1	103	HO834D	1	259	HO894	1	258
HO737	1	250	HO786A	1	103	HO834E	1	259	HO894A	1	258
HO738	1	233	HO786B	1	103	HO834H	1	246	HO895	2	258
HO740	1	233	HO787	1	103	HO835	1	242	HO895A	1	258

*Uxv= UNIDADES POR VEHÍCULO

TABLA DE CÓDIGOS

CÓDIGO	UXV	PÁG	CÓDIGO	UXV	PÁG	CÓDIGO	UXV	PÁG	CÓDIGO	UXV	PÁG
HO896	1	235	HO949B	1	248	HOJ419H	1	69	HOKC217	4	114
HO897	1	235	HO949C	1	248	HOJ433H	2	69	HOKC218	2	115
HO897A	1	248	HO949D	1	246	HOJ437H	2	69	HOKC219	2	115
HO897B	1	235	HO949J	1	246	HOJ461H	1	69	HOKC220	2	115
HO898	1	246	HO950	2	77	HOKC100	2	108	HOKC221	2	115
HO899A	1	102	HO951	2	77	HOKC1001	2	193	HOKC222	2	115
HO900A	2	48	HO952	2	77	HOKC1002	2	193	HOKC223	2	115
HO900B	2	48	HO952T	1	79	HOKC1003	4	193	HOKC224	2	116
HO900C	2	48	HO953	2	77	HOKC101	2	108	HOKC225	2	116
HO900D	2	48	HO954	2	77	HOKC102	2	108	HOKC226	2	116
HO900E	2	48	HO955	2	77	HOKC103	2	108	HOKC227	2	116
HO900F	4	48	HO956	2	77	hokc104	2	108	HOKC227A	2	116
HO900H	2	47	HO957	2	77	hokc105	2	108	HOKC228	2	116
HO900J	2	47	HO958	2	77	HOKC106	2	109	HOKC229	2	117
HO902	1	243	HO959	2	77	hokc107	2	109	HOKC230	2	117
HO903	1	243	HO960	2	77	hokc108	2	109	HOKC231	2	117
HO904A	2	92	HO961	2	77	HOKC109	2	109	HOKC232	2	117
HO905A	2	92	HO962	2	77	HOKC1100	4	193	HOKC233	2	117
HO906A	2	92	HO963	2	77	HOKC1101	4	193	HOKC236	2	117
HO907	1	234	HO964	2	77	HOKC1102	2	194	HOKC237	2	118
HO907A	2	92	HO965	2	77	HOKC1103	2	194	HOKC238	2	118
HO908	2	243	HO966	2	77	HOKC1104	2	194	HOKC239	2	118
HO908A	2	92	HO966A	2	77	HOKC1105	2	194	HOKC240	2	118
HO909	2	243	HO967	2	77	HOKC1106	2	194	HOKC241	2	118
HO909A	2	92	HO969	1	246	HOKC111	2	109	HOKC241A	2	118
HO911	1	250	HO970	1	248	HOKC112	2	109	HOKC242	2	119
HO912	2	96	HO970A	1	240	HOKC113	2	110	HOKC243	4	119
HO913	2	96	HO971	1	258	HOKC114	2	110	HOKC244	2	119
HO914	2	96	HO972	1	258	HOKC115	2	110	HOKC245	2	119
HO915	2	243	HO973	1	258	HOKC116	2	110	HOKC246	2	119
HO916	1	248	HO974	1	258	HOKC117	2	110	HOKC247	2	119
HO917	3	243	HO975	1	258	HOKC118	2	110	HOKC248	2	120
HO917A	3	243	HO976	1	258	HOKC119	2	111	HOKC249	2	120
HO917B	3	243	HO977	1	240	HOKC1200	2	194	HOKC250	2	120
HO918	3	243	HO978	1	246	HOKC1201	2	195	HOKC251	2	120
HO919	3	243	HO980	1	246	HOKC1202	2	195	HOKC252	2	120
HO920	3	243	HO981	2	77	HOKC1203	4	195	HOKC253	2	120
HO921	3	243	HO982	2	77	HOKC1300	2	195	HOKC254	2	121
HO921A	3	243	HO983	2	77	HOKC1301	2	195	HOKC255	2	121
HO921B	3	243	HOJ015H	2	69	HOKC1302	2	195	HOKC256	2	121
HO922	2	96	HOJ052HE	2	59	HOKC1400	2	196	HOKC257	2	121
HO922A	2	96	HOJ080H	2	69	HOKC1401	2	196	HOKC258	2	121
HO941	3	250	HOJ088H	2	61	HOKC1402	2	196	HOKC259	2	121
HO941A	1	250	HOJ089H	2	61	HOKC1500	2	196	HOKC260	2	122
HO941B	1	251	HOJ090H	2	69	HOKC200C	2	111	HOKC261	4	122
HO941C	1	251	HOJ090HA	2	69	HOKC200L	2	111	HOKC262	2	122
HO941D	1	251	HOJ090HB	2	69	HOKC201	2	111	HOKC263	2	122
HO941E	1	251	HOJ102H	2	59	HOKC202	2	111	HOKC264	2	122
HO941F	1	251	HOJ102HA	2	59	HOKC202A	2	111	HOKC265	2	122
HO941G	1	251	HOJ102HB	2	61	HOKC202B	2	112	HOKC266	2	123
HO941H	1	251	HOJ103H	2	61	HOKC203	2	112	HOKC267	2	123
HO941J	1	251	HOJ149H	2	69	HOKC204	2	112	HOKC268	2	123
HO941K	1	251	HOJ150H	2	69	HOKC205	2	112	HOKC269	2	123
HO941L	1	251	HOJ165H	2	59	HOKC206	4	112	HOKC270	2	123
HO941M	1	251	HOJ165HA	2	59	HOKC207	2	112	HOKC271	2	123
HO941N	1	251	HOJ165JH	2	69	HOKC208	2	113	HOKC272	2	124
HO942	1	251	HOJ166H	2	61	HOKC209	2	113	HOKC273	2	124
HO942E	1	251	HOJ183H	2	61	HOKC210	2	113	HOKC274	2	124
HO943	1	251	HOJ183HA	2	61	HOKC211	2	113	HOKC275	2	124
HO944	1	251	HOJ184H	2	61	HOKC212	2	113	HOKC276	2	124
HO947	1	251	HOJ184HA	2	61	HOKC213	2	113	HOKC277	2	124
HO947A	1	251	HOJ185H	2	61	HOKC213A	2	114	HOKC300	2	125
HO947B	1	251	HOJ186H	2	61	HOKC214	2	114	HOKC301	4	125
HO947C	1	251	HOJ235H	1	90	HOKC214A	2	114	HOKC302	2	125
HO949	1	246	HOJ408H	2	69	HOKC215	2	114	HOKC303	2	125
HO949A	1	246	HOJ413H	2	69	HOKC216	2	114	HOKC304	2	125

TABLA DE CÓDIGOS



CÓDIGO	UXV	PÁG	CÓDIGO	UXV	PÁG	CÓDIGO	UXV	PÁG	CÓDIGO	UXV	PÁG
HOKC305	2	125	HOKC370	2	136	HOKC447	2	147	HOKC538	2	158
HOKC306	2	126	HOKC371	2	137	HOKC448	2	148	HOKC539	2	159
HOKC307	4	126	HOKC372	2	137	HOKC449	2	148	HOKC540	2	159
HOKC308	2	126	HOKC373	2	137	HOKC450	2	148	HOKC541	2	159
HOKC309	2	126	HOKC374	2	137	HOKC452	4	148	HOKC542	2	159
HOKC310	2	126	HOKC375	2	137	HOKC453	2	148	HOKC543	2	159
HOKC311	2	126	HOKC376	2	137	HOKC454	2	148	HOKC544	2	159
HOKC312	2	127	HOKC377	2	138	HOKC455	2	149	HOKC545	2	160
HOKC313	2	127	HOKC378	2	138	HOKC456	4	149	HOKC600	2	160
HOKC314	2	127	HOKC379	2	138	HOKC457	2	149	HOKC601	2	160
HOKC315	2	127	HOKC380	2	138	HOKC458	2	149	HOKC602	2	160
HOKC316	2	127	HOKC381	2	138	HOKC459	2	149	HOKC603	2	160
HOKC317	2	127	HOKC382	2	138	HOKC460	2	149	HOKC603A	2	160
HOKC318	2	128	HOKC383	2	139	HOKC461	2	150	HOKC604	2	161
HOKC319	2	128	HOKC384	2	139	HOKC462	2	150	HOKC604A	2	161
HOKC320	4	128	HOKC385	2	139	HOKC463	2	150	HOKC604B	2	161
HOKC321	4	128	HOKC386	2	139	HOKC464	2	150	HOKC604C	2	161
HOKC322	2	128	HOKC387	2	139	HOKC465	2	150	HOKC604H	2	161
HOKC322A	2	128	HOKC388	2	139	HOKC466	2	150	HOKC605	2	161
HOKC323	2	129	HOKC400	2	140	HOKC467	2	151	HOKC606	2	162
HOKC324	2	129	HOKC401	2	140	HOKC468	2	151	HOKC606A	2	162
HOKC325	2	129	HOKC402	2	140	HOKC469	2	151	HOKC606B	2	162
HOKC326	2	129	HOKC403	2	140	HOKC470	2	151	HOKC607	2	162
HOKC327	2	129	HOKC404	2	140	HOKC471	2	151	HOKC608	2	162
HOKC328	2	129	HOKC405	2	140	HOKC472	2	151	HOKC609	2	162
HOKC329	2	130	HOKC406	2	141	HOKC473	2	152	HOKC610	2	163
HOKC330	2	130	HOKC407	2	141	HOKC474	2	152	HOKC6101	2	163
HOKC331	2	130	HOKC408	2	141	HOKC475	2	152	HOKC6103	2	196
HOKC332	2	130	HOKC408A	2	141	HOKC500	2	152	HOKC6104	2	196
HOKC333	2	130	HOKC409	2	141	HOKC500A	2	152	HOKC6105	2	197
HOKC334	2	130	HOKC410	2	141	HOKC500B	2	152	HOKC6106	2	197
HOKC335	2	131	HOKC411	2	142	HOKC501	2	152	HOKC611	2	163
HOKC336	2	131	HOKC412	2	142	HOKC501A	2	153	HOKC611	2	163
HOKC337	2	131	HOKC413	2	142	HOKC502	2	153	HOKC612	2	163
HOKC338	2	131	HOKC414	2	142	HOKC503	2	153	HOKC613	2	163
HOKC339	2	131	HOKC415	2	142	HOKC504	2	153	HOKC613A	2	163
HOKC340	2	131	HOKC416	2	142	HOKC505	2	153	HOKC613B	2	164
HOKC341	2	132	HOKC417	2	143	HOKC506	2	153	HOKC613C	2	164
HOKC342	2	132	HOKC418	2	143	HOKC507	2	154	HOKC613D	2	164
HOKC343	2	132	HOKC419	2	143	HOKC508	2	154	HOKC614	2	164
HOKC344	2	132	HOKC420	2	143	HOKC509	2	154	HOKC614A	2	164
HOKC345	2	132	HOKC421	2	143	HOKC510	2	154	HOKC615	2	164
HOKC346	2	132	HOKC422	2	143	HOKC511	2	154	HOKC615A	2	165
HOKC347	2	133	HOKC423	2	144	HOKC512	2	154	HOKC616	2	165
HOKC348	4	133	HOKC424	2	144	HOKC513	2	155	HOKC617	2	165
HOKC349	2	133	HOKC425	2	144	HOKC514	2	155	HOKC617A	2	165
HOKC350	2	133	HOKC426	2	144	HOKC515	2	155	HOKC618	2	165
HOKC351	2	133	HOKC427	2	144	HOKC516	2	155	HOKC618A	2	165
HOKC352	2	133	HOKC428	2	144	HOKC517	2	155	HOKC619	2	166
HOKC353	2	134	HOKC429	2	145	HOKC518	2	155	HOKC619A	2	166
HOKC354	2	134	HOKC430	2	145	HOKC519	2	156	HOKC620	2	166
HOKC355	2	134	HOKC431	2	145	HOKC520	2	156	HOKC621	2	166
HOKC356	2	134	HOKC432	2	145	HOKC521	2	156	HOKC622	2	166
HOKC357	2	134	HOKC433	2	145	HOKC522	2	156	HOKC623	2	166
HOKC358	2	134	HOKC434	2	145	HOKC523	2	156	HOKC624	2	167
HOKC359	2	135	HOKC435	2	146	HOKC524	2	156	HOKC625	2	167
HOKC360	2	135	HOKC436	2	146	HOKC525	2	157	HOKC626	2	167
HOKC361	2	135	HOKC437	2	146	HOKC526	2	157	HOKC627	2	167
HOKC362	2	135	HOKC438	2	146	HOKC527	2	157	HOKC628	2	167
HOKC363	2	135	HOKC439	2	146	HOKC528	2	157	HOKC629	2	167
HOKC364	2	135	HOKC440	2	146	HOKC530	2	157	HOKC630	2	168
HOKC365	2	136	HOKC441	2	146	HOKC532	2	157	HOKC631	2	168
HOKC366	2	136	HOKC442	2	147	HOKC533	2	158	HOKC632	2	168
HOKC367	2	136	HOKC443	2	147	HOKC534	2	158	HOKC633	2	168
HOKC368	2	136	HOKC444	2	147	HOKC535	2	158	HOKC633A	2	168
HOKC369	2	136	HOKC445	2	147	HOKC536	2	158	HOKC634	2	168
			HOKC446	2	147	HOKC537	2	158	HOKC635	2	169

*UxV= UNIDADES POR VEHÍCULO

TABLA DE CÓDIGOS

CÓDIGO	UXV	PÁG	CÓDIGO	UXV	PÁG	CÓDIGO	UXV	PÁG	CÓDIGO	UXV	PÁG
HOKC636	2	169	HOKC731	2	180	HOKC939	2	191	HOKT106L	1	199
HOKC637	2	169	HOKC732	2	180	HOKC940	2	191	HOKT107L	1	199
HOKC638	2	169	HOKC733	2	180	HOKC941	2	191	HOKT108L	1	199
HOKC639	2	169	HOKC734	2	180	HOKC942	2	191	HOKT109R	1	200
HOKC641	2	169	HOKC735	2	180	HOKC943	2	191	HOKT112L	1	200
HOKC642	2	170	HOKC736	2	181	HOKC944	2	192	HOKT113L	1	200
HOKC643	2	170	HOKC737	2	181	HOKC945	2	192	HOKT117R	1	200
HOKC644	2	170	HOKC800	2	181	HOKC946	2	192	HOKT118R	1	200
HOKC645	2	170	HOKC801	2	181	HOKC947	2	192	HOKT123L	1	200
HOKC646	2	170	HOKC802	2	181	HOKC948	2	192	HOKT125R	1	201
HOKC647	2	170	HOKC803	2	181	HOKC949	2	192	HOKT126L	1	201
HOKC648	2	171	HOKC804	2	182	HOKC950	2	193	HOKT127L	1	201
HOKC649	2	171	HOKC805	2	182	HOKRD200	2	227	HOKT129	1	201
HOKC650	2	171	HOKC806	2	182	HOKRD201	2	227	HOKT130	1	201
HOKC652	2	171	HOKC807	2	182	HOKRD202	2	227	HOKT131	1	201
HOKC653	2	171	HOKC808	2	182	HOKRD203	2	227	HOKT132	1	202
HOKC655	2	171	HOKC809	2	182	HOKRD204	2	227	HOKT133	1	202
HOKC656	2	172	HOKC810	2	183	HOKRD300	2	227	HOKT134L	2	202
HOKC657	2	172	HOKC811	2	183	HOKRD301	2	227	HOKT2001	1	226
HOKC658	2	172	HOKC812	2	183	HOKRD302	2	227	HOKT2002	1	226
HOKC659	2	172	HOKC900	2	183	HOKRD303	2	228	HOKT201R	1	202
HOKC660	2	172	HOKC900A	2	183	HOKRD306	2	228	HOKT202L	1	202
HOKC661	2	172	HOKC900B	2	183	HOKRD307	2	228	HOKT203L	1	202
HOKC662	2	173	HOKC900C	2	184	HOKRD401	2	228	HOKT204L	1	203
HOKC663	2	173	HOKC900D	2	184	HOKRD403	2	228	HOKT205L	1	203
HOKC665	2	173	HOKC901	2	184	HOKRD404	2	228	HOKT206L	1	203
HOKC666	2	173	HOKC901A	2	184	HOKRD405	2	228	HOKT207L	1	203
HOKC667	2	173	HOKC902	2	184	HOKRD406	2	228	HOKT208R	1	203
HOKC668	2	173	HOKC902A	2	184	HOKRD501	2	229	HOKT209L	1	203
HOKC669	2	174	HOKC903	2	185	HOKRD502	2	229	HOKT210L	1	204
HOKC670	2	174	HOKC903A	2	185	HOKRD600	2	229	HOKT211L	1	204
HOKC671	2	174	HOKC903B	2	185	HOKRD601	2	229	HOKT212L	1	204
HOKC672	2	174	HOKC904	2	185	HOKRD602	2	229	HOKT215L	1	204
HOKC673	2	174	HOKC905	2	185	HOKRD603	2	229	HOKT216L	1	204
HOKC674	2	174	HOKC905A	2	185	HOKRT100	2	230	HOKT222L	1	204
HOKC675	2	175	HOKC906	2	186	HOKRT200	2	230	HOKT223L	1	205
HOKC701	2	175	HOKC907	2	186	HOKRT201	2	230	HOKT224L	1	205
HOKC702	2	175	HOKC908	2	186	HOKRT202	2	230	HOKT225L	1	205
HOKC703	2	175	HOKC908B	2	186	HOKRT302	2	230	HOKT226R	1	205
HOKC704	2	175	HOKC909	2	186	HOKRT303	2	230	HOKT227	1	205
HOKC705	2	175	HOKC910	2	186	HOKRT304	2	230	HOKT228	1	205
HOKC706	2	176	HOKC911	2	187	HOKRT305	2	230	HOKT229R	1	206
HOKC707	2	176	HOKC912	2	187	HOKRT306	2	230	HOKT230R	1	206
HOKC708	2	176	HOKC913	2	187	HOKRT307	2	230	HOKT231	1	206
HOKC710	2	176	HOKC914	2	187	HOKRT308	2	231	HOKT232	1	206
HOKC711	2	176	HOKC915	2	187	HOKRT402	2	231	HOKT233	1	206
HOKC712	2	176	HOKC916	2	187	HOKRT403	2	231	HOKT234L	1	206
HOKC713	2	177	HOKC917	2	188	HOKRT404	2	231	HOKT235L	1	207
HOKC713A	2	177	HOKC918	2	188	HOKRT405	2	231	HOKT236	2	207
HOKC714	2	177	HOKC919	2	188	HOKRT500	2	231	HOKT238	2	207
HOKC715	2	177	HOKC921	2	188	HOKRT501	2	231	HOKT239	2	207
HOKC716	2	177	HOKC923	2	188	HOKRT502	2	231	HOKT240	2	207
HOKC717	2	177	HOKC924	2	188	HOKRT700	2	231	HOKT240R	1	207
HOKC718	2	178	HOKC925	2	189	HOKT000	2	197	HOKT241L	1	208
HOKC719	2	178	HOKC926	2	189	HOKT001	2	197	HOKT3002L	1	226
HOKC720	2	178	HOKC927	2	189	HOKT002	2	197	HOKT300L	1	208
HOKC721	2	178	HOKC928	2	189	HOKT003	2	197	HOKT301R	1	208
HOKC722	2	178	HOKC929	2	189	HOKT004	2	198	HOKT302L	1	208
HOKC723	2	178	HOKC930	2	189	hokt006R	1	198	HOKT303	1	208
HOKC724	2	179	HOKC931	2	190	HOKT007	1	198	HOKT305L	1	208
HOKC725	2	179	HOKC932	2	190	HOKT008L	1	198	HOKT306L	1	209
HOKC726	2	179	HOKC933	2	190	HOKT101L	1	198	HOKT307	1	209
HOKC727	2	179	HOKC935	2	190	HOKT102L	1	198	HOKT309L	1	209
HOKC728	2	179	HOKC936	2	190	HOKT103L	1	199	HOKT310L	1	209
HOKC729	2	179	HOKC937	2	190	HOKT104L	1	199	HOKT311L	1	209
HOKC730	2	180	HOKC938	2	191	HOKT105L	1	199	HOKT313L	1	209

TABLA DE CÓDIGOS



CÓDIGO	UXV	PÁG	CÓDIGO	UXV	PÁG	CÓDIGO	UXV	PÁG	CÓDIGO	UXV	PÁG
HOKT314	1	210	HOKT626L	1	221	JR1202	2	81	JR1405	2	85
HOKT315R	1	210	HOKT627L	1	221	JR1203	2	82	JR1406	2	85
HOKT319L	1	210	HOKT628	1	221	JR1204	2	82	JR1407	2	85
HOKT320L	1	210	HOKT629L	1	221	JR1205	2	82	JR1408	2	85
HOKT322L	1	210	HOKT630	1	221	JR1206	2	82	JR1409	2	85
HOKT323R	1	210	HOKT631	1	221	JR1207	2	82	JR1410	2	85
HOKT332R	1	211	HOKT632	1	222	JR1208	2	82	JR1411	2	85
HOKT334	1	211	HOKT633R	1	222	JR1209L	2	82	JR1413	2	86
HOKT335	1	211	HOKT634L	2	222	JR1209R	2	82	JR1414	2	86
HOKT336	1	211	HOKT635L	1	222	JR1211L	2	82	JR1415	2	86
HOKT337L	1	211	HOKT636	2	222	JR1211R	2	82	JR1500	2	86
HOKT339L	1	211	HOKT637	2	222	JR1212L	2	82	JR1501	2	86
HOKT401L	1	212	HOKT638	2	223	JR1212R	2	82	JR1502	2	86
HOKT402	1	212	HOKT639L	1	223	JR1213	2	82	JR1503	2	86
HOKT403R	1	212	HOKT700R	1	223	JR1214	2	82	JR1504	2	86
HOKT404L	1	212	HOKT701L	1	223	JR1216	2	82	JR1508	2	86
HOKT405L	1	212	HOKT702L	1	223	JR1217	2	82	JR1509	2	86
HOKT406R	1	212	HOKT703	1	223	JR1218	2	82	JR1510	2	86
HOKT407L	1	213	HOKT704	2	224	JR1219	2	82	JR1511	2	86
HOKT408L	1	213	HOKT800R	1	224	JR1220	2	83	JR1600	2	86
HOKT409L	1	213	HOKT801	1	224	JR1221	2	83	JR1600T	2	86
HOKT410R	1	213	HOKT801R	1	224	JR1234	2	83	JR1601T	2	86
HOKT412L	1	213	HOKT802L	1	224	JR1300	2	83	JR1603	2	86
HOKT413R	1	213	HOKT803L	1	224	JR1301	2	83	JR1605	2	86
HOKT416	1	214	HOKT804	2	225	JR1302	2	83	JR1606	2	86
HOKT417R	1	214	HOKT805L	2	225	JR1303	2	83	JR1607	2	87
HOKT418R	1	214	HOKT901R	1	225	JR1304	2	83	JR1608	2	87
HOKT419	1	214	HOKT904L	1	225	JR1305	2	83	JR1609	2	87
HOKT420	2	214	HOKT905L	1	225	JR1306	2	83	JR1610	2	87
HOKT421R	1	214	HOKT906L	1	226	JR1307	2	83	JR1611	2	87
HOKT500L	1	215	HOKT907L	1	226	JR1308	2	83	JR1700	2	87
HOKT501L	1	215	HOKT908L	1	226	JR1309	2	83	JR1701	2	87
HOKT502L	1	215	JR1000	2	80	JR1310	2	83	JR1702	2	87
HOKT503L	1	215	JR1001	2	80	JR1312L	2	83	JR1800	2	87
HOKT504L	1	215	JR1002	2	80	JR1312R	2	83	JR1801L	2	87
HOKT505L	1	215	JR1003	2	80	JR1313L	2	83	JR1801R	2	87
HOKT506L	1	216	JR1004	2	80	JR1313R	2	83	JR1802	2	87
HOKT507L	1	216	JR1005	2	80	JR1314	2	84	JR1900	2	87
HOKT512L	1	216	JR1100	2	80	JR1315	2	84	JR1901L	2	87
HOKT513R	1	216	JR1101	2	80	JR1316L	2	84	JR1901R	2	87
HOKT514R	1	216	JR1102	2	80	JR1316R	2	84	JR1903L	2	87
HOKT515L	1	216	JR1103	2	80	JR1317	2	84	JR1903R	2	87
HOKT516L	1	217	JR1104L	2	80	JR1318	2	84	JR2000	2	87
HOKT517R	1	217	JR1104R	2	80	JR1319	2	84	RS100	1	102
HOKT518L	1	217	JR1108	2	80	JR1320	2	84	RS200	1	102
HOKT520L	1	217	JR1109L	2	80	JR1321L	2	84	RS283	2	73
HOKT521L	1	217	JR1110	2	80	JR1321R	2	84	RS283D	2	73
HOKT522L	1	217	JR1111	2	80	JR1322L	2	84	RS312	1	102
HOKT600R	1	218	JR1112	2	80	JR1322R	2	84	RS350	1	102
HOKT601R	1	218	JR1113L	2	81	JR1324L	2	84	RS400	2	73
HOKT602R	1	218	JR1113R	2	81	JR1324R	2	84			
HOKT603L	1	218	JR1114L	2	81	JR1325	2	84			
HOKT604L	1	218	JR1114R	2	81	JR1326	2	84			
HOKT605L	1	218	JR1115	2	81	JR1327L	2	84			
HOKT612L	1	219	JR1116L	2	81	JR1327R	2	84			
HOKT613R	1	219	JR1116R	2	81	JR1328	2	85			
HOKT614R	1	219	JR1117L	2	81	JR1329	2	85			
HOKT615R	1	219	JR1117R	2	81	JR1330L	2	85			
HOKT617R	1	219	JR1119	2	81	JR1331R	2	85			
HOKT618R	1	219	JR1120	2	81	JR1332	2	85			
HOKT619R	1	220	JR1121	2	81	JR1338	2	85			
HOKT620R	1	220	JR1122	2	81	JR1400	2	85			
HOKT621L	1	220	JR1123	2	81	JR1401	2	85			
HOKT622L	1	220	JR1124	2	81	JR1402	2	85			
HOKT623L	1	220	JR1200	2	81	JR1403	2	85			
HOKT625L	1	220	JR1201	2	81	JR1404	2	85			

*UxV= UNIDADES POR VEHÍCULO

FRENOS HO 2024-2025





PISTONES



PÁG.	CÓDIGO	UXV	BALATA	FMSI	h. ALTURA	Ø DIÁMETRO PISTÓN	REPUESTO	TIPO CUBREPOLVO	TIPO DE PISTÓN
28	HO216A	2	7339	D459	56.00	85.90	HOR216A	DURO	SIN RANURA
28	HO216A	2	7081A	D149	56.00	85.90	HOR216A	DURO	SIN RANURA
28	HO216	2	7081	D149	56.40	85.50	HOR216	BLANDO	SIN RANURA
28	HO216	2	7815	D380	56.40	85.50	HOR216	BLANDO	SIN RANURA
27	HO211C	2	7260	D370	54.90	79.92	HOR211C	DURO	SIN RANURA
32	HO212	2	7019	D86	45.00	78.68	HOR212	DURO	SIN RANURA
32	HO212	2	7019	D269	45.00	78.68	HOR212	DURO	SIN RANURA
32	HO212	2	7019	D123	45.00	78.68	HOR212	DURO	SIN RANURA
32	HO212	2	7179	D269	45.00	78.68	HOR212	DURO	SIN RANURA
32	HO212A	2	781	D39	45.00	78.66	HOR212A	BLANDO	SIN RANURA
32	HO212A	2	781	D92	45.00	78.66	HOR212A	BLANDO	SIN RANURA
27	HO211	2	728A	D52	49.00	74.50	HOR211	DURO	SIN RANURA
27	HO211	2	728	D52	49.00	74.50	HOR211	DURO	SIN RANURA
27	HO211D	2	7259	D369	54.70	74.50	HOR211D	DURO	SIN RANURA
39	HO210A	2	7013A	D50	45.00	73.00	HOR210A	BLANDO	SIN RANURA
39	HO210A	2	7082A	D150	45.00	73.00	HOR210A	BLANDO	SIN RANURA
39	HO210A	2	7082C	D199	45.00	73.00	HOR210A	BLANDO	SIN RANURA
27	HO211E	4	7141	D224	70.80	73.00	HOR211E	BLANDO	SIN RANURA
27	HO211E	4	7808	D225	70.80	73.00	HOR211E	BLANDO	SIN RANURA
27	HO211E	4	7818	D225	70.80	73.00	HOR211E	BLANDO	SIN RANURA
41	HO217C	2	7082A	D150	46.00	73.00	HOR217C	BLANDO	SIN RANURA
41	HO217C	2	7378B	D499	46.00	73.00	HOR217C	BLANDO	SIN RANURA
39	HO210	2	7503	D632	48.30	72.98	HOR210	DURO	SIN RANURA
40	HO210M	2	7809	D236	75.00	72.90	HOR210M	BLANDO	SIN RANURA
32	HO217F	4	7636	D1032	54.30	69.95	HOR217F	DURO	SIN RANURA
32	HO209	2	7017	D84	45.00	69.85	HOR209	BLANDO	SIN RANURA
32	HO209	2	773	D33	45.00	69.85	HOR209	BLANDO	SIN RANURA
32	HO212B	2	7616	D746	55.90	69.80	HOR212B	DURO	SIN RANURA
32	HO212B	2	7616	D820	55.90	69.80	HOR212B	DURO	SIN RANURA
52	HO2013	2	8552	D1434	48.20	66.57	HOR2013	BLANDO	SIN RANURA
52	HO2013	2	7205	D303	48.20	66.57	HOR2013	BLANDO	SIN RANURA
40	HO210L	2	7224	D326	46.00	65.98	HOR210L	DURO	SIN RANURA
40	HO210L	2	7488	D607	46.00	65.98	HOR210L	DURO	SIN RANURA
40	HO210L	2	7125	D387	46.00	65.98	HOR210L	DURO	SIN RANURA
42	HO217T	2	7950	D1047	56.00	65.98	HOR217T	DURO	SIN RANURA
33	HO212D	2	7507	D477	51.00	65.94	HOR212D	DURO	SIN RANURA
33	HO212D	2	7732	D856	51.00	65.94	HOR212D	DURO	SIN RANURA
33	HO212G	2	7733	D857	52.00	65.94	HOR212G	DURO	SIN RANURA
41	HO217D	2	7654	D786	58.00	65.94	HOR217D	DURO	SIN RANURA
42	HO3203	4	9249	D2018	58.60	65.90	HOR3203	DURO	SIN RANURA
34	HO212X	2	8389	D1273	53.57	65.86	HOR212X	BLANDO	SIN RANURA
34	HO212X	2	8389	D1327	53.57	65.86	HOR212X	BLANDO	SIN RANURA
32	HO216S	4	7914	D1010	60.50	65.86	HOR216S	DURO	SIN RANURA
32	HO217H	2	7658	D788	49.43	65.86	HOR217H	DURO	SIN RANURA
35	HO3105	4	8446	D1335	60.50	65.86	HOR3105	DURO	SIN RANURA
33	HO212K	2	7410	D593	52.00	65.85	HOR212K	DURO	SIN RANURA
33	HO212K	2	7410	D529	52.00	65.85	HOR212K	DURO	SIN RANURA
41	HO215	2	7027A	D91	46.00	65.85	HOR215	BLANDO	SIN RANURA

INDICE DE PISTÓN Y REPUESTO



PÁG.	CÓDIGO	UXV	BALATA	FMSI	h. ALTURA	Ø DIÁMETRO PISTÓN	REPUESTO	TIPO CUBREPOLVO	TIPO DE PISTÓN
41	HO215	2	7017A	D84	46.00	65.85	HOR215	BLANDO	SIN RANURA
41	HO215	2	7017	D84	46.00	65.85	HOR215	BLANDO	SIN RANURA
41	HO215	2	7536	D656	46.00	65.85	HOR215	BLANDO	SIN RANURA
41	HO217B	2	7478	D600	46.00	65.85	HOR217B	DURO	SIN RANURA
41	HO217B	2	7479	D601	46.00	65.85	HOR217B	DURO	SIN RANURA
47	HO2105	2	7663	D793	51.75	64.22	HOR2105	BLANDO	SIN RANURA
33	HO212F	2	7732	D856	53.15	63.95	HOR212F	DURO	SIN RANURA
28	HO211U	2	7720	D844	55.78	63.70	HOR211U	DURO	SIN RANURA
29	HO216C	2	7259	D369	55.00	63.50	HOR216C	DURO	SIN RANURA
31	HO216J	2	7480A	D202	43.50	63.50	HOR216J	DURO	SIN RANURA
31	HO216J	2	7759	D882	43.50	63.50	HOR216J	DURO	SIN RANURA
31	HO216J	2	7070	D202	43.50	63.50	HOR216J	DURO	SIN RANURA
27	HO211A	2	7136	D215	43.00	63.44	HOR211A	DURO	SIN RANURA
27	HO211A	2	7070A	D154	43.00	63.44	HOR211A	DURO	SIN RANURA
27	HO211A	2	7070A	D138	43.00	63.44	HOR211A	DURO	SIN RANURA
27	HO211A	2	7070A	D202	43.00	63.44	HOR211A	DURO	SIN RANURA
44	HO207K	2	7870	D969	50.50	63.40	HOR207K	BLANDO	SIN RANURA
27	HO211K	4	7807	D224	56.30	63.38	HOR211K	BLANDO	SIN RANURA
31	HO216P	2	7574	D699	58.50	63.38	HOR216P	DURO	SIN RANURA
31	HO216P	2	7693	D818	58.50	63.38	HOR216P	DURO	SIN RANURA
47	HO2102	2	7844	D943	48.45	63.37	HOR2102	BLANDO	SIN RANURA
51	HO2004	2	7787	D908	52.75	63.30	HOR2004	BLANDO	SIN RANURA
51	HO2004	2	8331	D1222	52.75	63.30	HOR2004	BLANDO	SIN RANURA
52	HO2012	2	7069	D433	50.00	60.50	HOR2012	BLANDO	SIN RANURA
52	HO2012	2	8307	D1188	50.00	60.50	HOR2012	BLANDO	SIN RANURA
52	HO2012	2	7485	D604	50.00	60.50	HOR2012	BLANDO	SIN RANURA
43	HO207A	2	7170	D265	48.80	60.48	HOR207A	BLANDO	SIN RANURA
45	HO207X	2	7171	D266	48.80	60.48	HOR207X	BLANDO	SIN RANURA
50	HO2302	2	8728	D1519	48.55	60.45	HOR2302	BLANDO	SIN RANURA
54	HO70604	2	9050	D1295	53.00	60.45	HOR70604	BLANDO	SIN RANURA
54	HO70604	2	9035	D1826	53.00	60.45	HOR70604	BLANDO	SIN RANURA
27	HO211G	2	7620	D752	52.00	60.43	HOR211G	BLANDO	SIN RANURA
27	HO211G	2	7735	D752	52.00	60.43	HOR211G	BLANDO	SIN RANURA
36	HO213M	2	7962	D1056	55.13	60.40	HOR213M	DURO	SIN RANURA
52	HO2017	2	7738	D862	51.50	60.38	HOR2017	BLANDO	SIN RANURA
52	HO2018	2	7167	D263	48.50	60.26	HOR2018	BLANDO	SIN RANURA
51	HO209I	2	7205	D438	48.50	60.26	HOR209I	BLANDO	SIN RANURA
51	HO209L	2	7581	D707	48.00	60.23	HOR209L	BLANDO	SIN RANURA
36	HO213G	2	7365	D484	49.00	60.23	HOR213G	BLANDO	SIN RANURA
41	HO217E	2	776	D34	45.00	60.23	HOR217E	BLANDO	SIN RANURA
41	HO217E	2	776	D237	45.00	60.23	HOR217E	BLANDO	SIN RANURA
48	HO211F	2	7347	D363	45.50	60.20	HOR211F	BLANDO	SIN RANURA
29	HO2503	2	8270	D1160	53.20	60.20	HOR2503	BLANDO	SIN RANURA
29	HO2503	2	7932	D1028	53.20	60.20	HOR2503	BLANDO	SIN RANURA
30	HO2513	2	8523	D1411	53.50	60.20	HOR2513	DURO	SIN RANURA
30	HO2513	2	8523	D1565	53.50	60.20	HOR2513	DURO	SIN RANURA
35	HO3104	1	8867	D1640	49.30	60.20	HOR3104	DURO	SIN RANURA
35	HO3104	1	8982	D1640	49.30	60.20	HOR3104	DURO	SIN RANURA

*Ø. = DIÁMETRO EXTERIOR

*h. = ALTURA

*CE. = CÓDIGO EQUIVALENTE

* TODOS LOS PISTONES INCLUYEN LIGA Y SILICÓN

FRENOS HO 2024-2025

15

PÁG.	CÓDIGO	UXV	BALATA	FMSI	h. ALTURA	Ø DIÁMETRO PISTÓN	REPUESTO	TIPO CUBREPOLVO	TIPO DE PISTÓN
35	HO3110	4	9462	D2223	56.00	60.20	HOR3110	DURO	SIN RANURA
51	HO2001	2	7581	D707	49.05	60.18	HOR2001	BLANDO	SIN RANURA
51	HO2001	2	7357	D476	49.05	60.18	HOR2001	BLANDO	SIN RANURA
51	HO2001	2	8969	D1210	49.05	60.18	HOR2001	BLANDO	SIN RANURA
35	HO3107	2	9003	D1640	49.30	60.12	HOR3107	DURO	SIN RANURA
35	HO3106	2	9003	D1640	53.50	60.10	HOR3106	DURO	SIN RANURA
42	HO3201	2	8836	D1623	47.20	60.08	HOR3201	DURO	SIN RANURA
50	HO2300	2	7741	D866	48.04	60.03	HOR2300	BLANDO	SIN RANURA
50	HO2300	2	7365	D484	48.04	60.03	HOR2300	BLANDO	SIN RANURA
54	HO70600	2	8722	D1513	46.00	60.00	HOR70600	BLANDO	SIN RANURA
31	HO2525	2	9114	D1886	50.50	60.00	HOR2525	DURO	SIN RANURA
31	HO216R	4	7914	D1010	59.00	59.98	HOR216R	DURO	SIN RANURA
31	HO216R	4	7962	D1066	59.00	59.98	HOR216R	DURO	SIN RANURA
30	HO2517	2	9072	D1844	55.90	59.95	HOR2517	BLANDO	SIN RANURA
30	HO2517	2	9072	D1913	55.90	59.95	HOR2517	BLANDO	SIN RANURA
40	HO210P	2	7719	D843	56.50	59.94	HOR210P	BLANDO	SIN RANURA
49	HO209M	2	7628	D760	49.80	59.93	HOR209M	DURO	SIN RANURA
39	HO210I	2	7630	D762	55.50	59.93	HOR210I	BLANDO	SIN RANURA
39	HO210I	2	7528	D745	55.50	59.93	HOR210I	BLANDO	SIN RANURA
48	HO212H	2	8247	D1137	51.50	59.93	HOR212H	BLANDO	SIN RANURA
48	HO212H	2	8247	D1072	51.50	59.93	HOR212H	BLANDO	SIN RANURA
48	HO212H	2	7X52	F004	51.50	59.93	HOR212H	BLANDO	SIN RANURA
44	HO207R	2	7456	D576	50.12	59.90	HOR207R	DURO	SIN RANURA
28	HO211S	2	8454	D784	58.92	59.90	HOR211S	DURO	SIN RANURA
28	HO211S	2	7974	D1069	58.92	59.90	HOR211S	DURO	SIN RANURA
28	HO211S	2	7653	D785	58.92	59.90	HOR211S	DURO	SIN RANURA
34	HO213B	2	7404A	D522	49.00	59.90	HOR213B	DURO	SIN RANURA
34	HO213B	2	7623	D730	49.00	59.90	HOR213B	DURO	SIN RANURA
41	HO217	2	7304A	D417	45.50	59.90	HOR217	BLANDO	SIN RANURA
41	HO217A	2	7106	D257	49.50	59.90	HOR217A	DURO	SIN RANURA
54	HO70607	2	9075	D1847	51.60	59.90	HOR70607	BLANDO	SIN RANURA
40	HO210K	4	7644	D777	58.50	59.89	HOR210K	DURO	SIN RANURA
40	HO210K	4	8507	D1399	58.50	59.89	HOR210K	DURO	SIN RANURA
27	HO211H	4	7652	D784	57.00	59.88	HOR211H	DURO	SIN RANURA
33	HO212M	2	7744	D869	55.40	59.87	HOR212M	DURO	SIN RANURA
29	HO2507	2	8667	D1467	51.50	59.84	HOR2507	DURO	SIN RANURA
29	HO2507	2	8730	D1522	51.50	59.84	HOR2507	DURO	SIN RANURA
29	HO2507	2	84X0	F368	51.50	59.84	HOR2507	DURO	SIN RANURA
38	HO208P	2	7299	D411	58.59	59.81	HOR208P	BLANDO	SIN RANURA
39	HO208T	4	7974	D1333	58.50	59.81	HOR208T	BLANDO	SIN RANURA
40	HO210Z	4	8440	D1328	53.36	59.81	HOR210Z	DURO	SIN RANURA
40	HO210Z	4	8909	D1680	53.36	59.81	HOR210Z	DURO	SIN RANURA
42	HO217U	4	7974	D1333	59.00	59.75	HOR217U	DURO	SIN RANURA
43	HO207E	2	7318	D815	51.00	57.12	HOR207E	BLANDO	SIN RANURA
43	HO207E	2	7318	D653	51.00	57.12	HOR207E	BLANDO	SIN RANURA
43	HO207E	2	7318	D430	51.00	57.12	HOR207E	BLANDO	SIN RANURA
43	HO207E	2	7783	D815	51.00	57.12	HOR207E	BLANDO	SIN RANURA
43	HO207E	2	7342	D485	51.00	57.12	HOR207E	BLANDO	SIN RANURA
43	HO207E	2	7235	D409	51.00	57.12	HOR207E	BLANDO	SIN RANURA

*Ø. = DIÁMETRO EXTERIOR

*h. = ALTURA

*CE.= CÓDIGO EQUIVALENTE

* TODOS LOS PISTONES INCLUYEN LIGA Y SILICÓN

INDICE DE PISTÓN Y REPUESTO



PÁG.	CÓDIGO	UXV	BALATA	FMSI	h. ALTURA	Ø DIÁMETRO PISTÓN	REPUESTO	TIPO CUBREPOLVO	TIPO DE PISTÓN
43	HO207E	2	7445	D409	51.00	57.12	HOR207E	BLANDO	SIN RANURA
51	HO209H	2	7441	D562	46.00	57.12	HOR209H	BLANDO	SIN RANURA
51	HO209H	2	7241	D349	46.00	57.12	HOR209H	BLANDO	SIN RANURA
36	HO213F	2	7716	D841	54.00	57.12	HOR213F	BLANDO	SIN RANURA
44	HO207M	2	8257	D1147	49.90	57.10	HOR207M	BLANDO	SIN RANURA
44	HO207M	2	772X	F191	49.90	57.10	HOR207M	BLANDO	SIN RANURA
51	HO209B	2	7127	D207	46.00	57.10	HOR209B	BLANDO	SIN RANURA
45	HO2400	2	7515	D637	47.60	57.10	HOR2400	BLANDO	SIN RANURA
46	HO209R	2	8849	D1760	53.60	57.05	HOR209R	BLANDO	SIN RANURA
46	HO209R	2	7656	D787	53.60	57.05	HOR209R	BLANDO	SIN RANURA
46	HO209D	2	7382	D503	53.80	57.01	HOR209D	BLANDO	SIN RANURA
46	HO209T	2	7795	D958	47.45	57.00	HOR209T	BLANDO	SIN RANURA
37	HO213P	8	7992	D1085	32.05	57.00	HOR213P	DURO	SIN RANURA
37	HO213P	8	8291	D1085	32.05	57.00	HOR213P	DURO	SIN RANURA
45	HO2404	2	8773	D1565	53.50	57.00	HOR2404	DURO	SIN RANURA
29	HO2504	4	8523	D1411	53.33	57.00	HOR2504	DURO	SIN RANURA
49	HO2508	4	7699	D827	54.00	57.00	HOR2508	BLANDO	SIN RANURA
54	HO70602	2	9143	D1912	51.00	57.00	HOR70602	BLANDO	SIN RANURA
54	HO70602	2	8904	D1827	51.00	57.00	HOR70602	BLANDO	SIN RANURA
54	HO70602	2	8810	D1828	51.00	57.00	HOR70602	BLANDO	SIN RANURA
47	HO2113	2	8883	D1654	51.00	57.00	HOR2113	BLANDO	SIN RANURA
36	HO3115	2	9412	D2169	53.00	57.00	HOR3115	BLANDO	DE ROSCA
47	HO2100	2	7573	D465	54.48	56.95	HOR2100	BLANDO	SIN RANURA
40	HO210N	2	7789	D910	54.00	56.95	HOR210N	DURO	SIN RANURA
34	HO212T	2	7741	D866	48.00	56.92	HOR212T	BLANDO	SIN RANURA
38	HO208M	4	8394	D1278	50.56	56.90	HOR208M	DURO	SIN RANURA
46	HO209Z	2	7795	D914	47.60	56.90	HOR209Z	BLANDO	SIN RANURA
46	HO209Z	2	7824	D923	47.60	56.90	HOR209Z	BLANDO	SIN RANURA
27	HO211B	2	7385	D506	44.00	56.90	HOR211B	DURO	SIN RANURA
27	HO211B	2	7070C	D183	44.00	56.90	HOR211B	DURO	SIN RANURA
31	HO216M	2	7652	D784	58.00	56.90	HOR216M	DURO	SIN RANURA
27	HO211J	2	768	F185	55.00	56.88	HOR211J	BLANDO	SIN RANURA
27	HO211J	2	8252	D1141	55.00	56.88	HOR211J	BLANDO	SIN RANURA
28	HO211M	2	7554	D673	51.00	56.85	HOR211M	DURO	SIN RANURA
28	HO211M	2	7385	D506	51.00	56.85	HOR211M	DURO	SIN RANURA
42	HO217N	2	7947	D1563	55.45	56.85	HOR217N	DURO	SIN RANURA
37	HO208A	4	7535	D655	55.50	56.00	HOR208A	BLANDO	SIN RANURA
37	HO208B	4	7436	D557	62.00	56.00	HOR208B	DURO	SIN RANURA
37	HO208B	4	7535	D655	62.00	56.00	HOR208B	DURO	SIN RANURA
33	HO212I	4	7535	D655	55.00	56.00	HOR212I	DURO	SIN RANURA
33	HO212I	4	7677	D655	55.00	56.00	HOR212I	DURO	SIN RANURA
33	HO212I	4	7694	D859	55.00	56.00	HOR212I	DURO	SIN RANURA
33	HO212N	4	7864	D965	55.00	56.00	HOR212N	DURO	SIN RANURA
37	HO208	4	7330	D450	48.00	55.40	HOR208	BLANDO	SIN RANURA
37	HO208	4	771	D20	48.00	55.40	HOR208	BLANDO	SIN RANURA
37	HO208	4	7054	D120	48.00	55.40	HOR208	BLANDO	SIN RANURA
49	HO209W	2	76X3	F134	50.00	54.00	HOR209W	BLANDO	SIN RANURA
49	HO209W	2	8254	D1499	50.00	54.00	HOR209W	BLANDO	SIN RANURA
42	HO217Z	2	8738	D1454	50.00	54.00	HOR217Z	BLANDO	SIN RANURA

*Ø. = DIÁMETRO EXTERIOR

*h. = ALTURA

* TODOS LOS PISTONES INCLUYEN LIGA Y SILICÓN

*CE. = CÓDIGO EQUIVALENTE

FRENOS HO 2024-2025

17

PÁG.	CÓDIGO	UXV	BALATA	FMSI	h. ALTURA	Ø DIÁMETRO PISTÓN	REPUESTO	TIPO CUBREPOLVO	TIPO DE PISTÓN
42	HO217Z	2	8653	D1454	50.00	54.00	HOR217Z	BLANDO	SIN RANURA
42	HO217Z	2	8X53	F520	50.00	54.00	HOR217Z	BLANDO	SIN RANURA
35	HO3108	4	7W04Z	F498	51.00	54.00	HOR3108	BLANDO	SIN RANURA
35	HO3108	4	9135	D1906	51.00	54.00	HOR3108	BLANDO	SIN RANURA
31	HO2527	2	757Y	F574	53.50	54.00	HOR2527	BLANDO	SIN RANURA
50	HO2901	1	8844	D1627	50.00	53.95	HOR2901	BLANDO	SIN RANURA
50	HO2904	2	7709	D768	58.00	53.95	HOR2904	BLANDO	SIN RANURA
34	HO213	2	7134	D220	49.90	53.94	HOR213	DURO	SIN RANURA
34	HO213	2	7403	D521	49.90	53.94	HOR213	DURO	SIN RANURA
34	HO213E	2	7530A	D650	48.00	53.94	HOR213E	DURO	SIN RANURA
53	HO214	2	7021	D45	33.30	53.94	HOR214	BLANDO	SIN RANURA
53	HO214E	2	8284	D1173	46.50	53.94	HOR214E	DURO	SIN RANURA
30	HO2514	2	8442	D1330	51.00	53.94	HOR2514	DURO	SIN RANURA
30	HO2514	2	8523	D1411	51.00	53.94	HOR2514	DURO	SIN RANURA
40	HO210J	2	8289	D1175	51.00	53.93	HOR210J	BLANDO	SIN RANURA
40	HO210J	2	75X6	F093	51.00	53.93	HOR210J	BLANDO	SIN RANURA
40	HO210J	2	7529	D649	51.00	53.93	HOR210J	BLANDO	SIN RANURA
54	HO214L	2	8212	D1107	55.00	53.93	HOR214L	DURO	SIN RANURA
54	HO214L	2	7635	D768	55.00	53.93	HOR214L	DURO	SIN RANURA
54	HO214L	2	7709	D768	55.00	53.93	HOR214L	DURO	SIN RANURA
43	HO207CA	2	795	D161	44.50	53.91	HOR207CA	BLANDO	SIN RANURA
43	HO207CA	2	7046	D113	44.50	53.91	HOR207CA	BLANDO	SIN RANURA
43	HO207CB	2	795	D161	37.70	53.91	HOR207CB	BLANDO	CON RANURA
43	HO207CB	2	7046	D113	37.70	53.91	HOR207CB	BLANDO	CON RANURA
44	HO207S	2	78Y0	F323	49.00	53.90	HOR207S	BLANDO	SIN RANURA
44	HO207S	2	7843	D941	49.00	53.90	HOR207S	BLANDO	SIN RANURA
44	HO207S	2	7546	D668	49.00	53.90	HOR207S	BLANDO	SIN RANURA
44	HO207S	2	7155	D233	49.00	53.90	HOR207S	BLANDO	SIN RANURA
44	HO207S	2	7435	D556	49.00	53.90	HOR207S	BLANDO	SIN RANURA
44	HO207S	2	8804	D1592	49.00	53.90	HOR207S	BLANDO	SIN RANURA
37	HO208D	2	7690	D816	55.00	53.90	HOR208D	DURO	SIN RANURA
37	HO208D	2	7947	D1044	55.00	53.90	HOR208D	DURO	SIN RANURA
37	HO208D	2	7947	D816	55.00	53.90	HOR208D	DURO	SIN RANURA
39	HO208S	4	7915	D1083	56.30	53.90	HOR208S	DURO	SIN RANURA
40	HO210S	4	7948	D1045	52.00	53.90	HOR210S	DURO	SIN RANURA
36	HO213H	2	7272	D383	46.00	53.90	HOR213H	BLANDO	SIN RANURA
31	HO216N	2	7305	D418	48.50	53.90	HOR216N	BLANDO	SIN RANURA
31	HO216N	2	7435	D556	48.50	53.90	HOR216N	BLANDO	SIN RANURA
45	HO2403	2	9269	D2038	53.50	53.90	HOR2403	BLANDO	SIN RANURA
45	HO2403	2	8804	D1592	53.50	53.90	HOR2403	BLANDO	SIN RANURA
45	HO2403	2	8X48	F381	53.50	53.90	HOR2403	BLANDO	SIN RANURA
45	HO2403	2	8404	D1592	53.50	53.90	HOR2403	BLANDO	SIN RANURA
42	HO3204	2	9018	D1790	52.00	53.90	HOR3204	DURO	SIN RANURA
39	HO208U	2	7973	D1334	53.48	53.88	HOR208U	BLANDO	SIN RANURA
40	HO210T	2	7949	D1046	52.14	53.88	HOR210T	DURO	SIN RANURA
40	HO210T	2	7949	D842	52.14	53.88	HOR210T	DURO	SIN RANURA
37	HO213R	4	7991	D1084	53.48	53.88	HOR213R	BLANDO	SIN RANURA
41	HO217M	4	8528	D1414	53.48	53.88	HOR217M	DURO	SIN RANURA
41	HO217M	4	9322	D2087	53.48	53.88	HOR217M	DURO	SIN RANURA

INDICE DE PISTÓN Y REPUESTO



PÁG.	CÓDIGO	UXV	BALATA	FMSI	h. ALTURA	Ø DIÁMETRO PISTÓN	REPUESTO	TIPO CUBREPOLVO	TIPO DE PISTÓN
41	HO217M	4	9018	D1790	53.48	53.88	HOR217M	DURO	SIN RANURA
41	HO217M	4	8816	D1602	53.48	53.88	HOR217M	DURO	SIN RANURA
41	HO217M	4	7991	D1084	53.48	53.88	HOR217M	DURO	SIN RANURA
42	HO217S	4	7973	D1334	53.48	53.88	HOR217S	DURO	SIN RANURA
29	HO2505	2	8987	D1759	49.00	53.88	HOR2505	BLANDO	SIN RANURA
29	HO2505	2	7779	D1035	49.00	53.88	HOR2505	BLANDO	SIN RANURA
43	HO207C	2	795	D57	26.70	53.87	HOR207C	BLANDO	SIN RANURA
43	HO207C	2	795	D161	26.70	53.87	HOR207C	BLANDO	SIN RANURA
43	HO207C	2	7046	D113	26.70	53.87	HOR207C	BLANDO	SIN RANURA
39	HO210D	2	7219	D466	44.00	53.87	HOR210D	BLANDO	SIN RANURA
39	HO210D	2	7353	D473	44.00	53.87	HOR210D	BLANDO	SIN RANURA
39	HO210D	2	7630	D762	44.00	53.87	HOR210D	BLANDO	SIN RANURA
29	HO216F	2	7700	D792	54.70	53.87	HOR216F	DURO	SIN RANURA
29	HO216F	2	7707	D834	54.70	53.87	HOR216F	DURO	SIN RANURA
29	HO216F	2	7653	D785	54.70	53.87	HOR216F	DURO	SIN RANURA
29	HO216F	2	7662	D792	54.70	53.87	HOR216F	DURO	SIN RANURA
45	HO207U	2	8456	D1345	47.00	53.86	HOR207U	DURO	SIN RANURA
45	HO207U	2	7Y93	F302	47.00	53.86	HOR207U	DURO	SIN RANURA
49	HO209A	2	7220	D320	45.40	53.86	HOR209A	BLANDO	SIN RANURA
34	HO212W	2	8266	D1156	47.25	53.86	HOR212W	BLANDO	SIN RANURA
34	HO213D	2	7869	D967	49.40	53.86	HOR213D	DURO	SIN RANURA
34	HO213D	2	7868	D967	49.40	53.86	HOR213D	DURO	SIN RANURA
34	HO213D	2	7868	D966	49.40	53.86	HOR213D	DURO	SIN RANURA
34	HO213D	2	7518A	D642	49.40	53.86	HOR213D	DURO	SIN RANURA
42	HO3205	2	8952	D1728	49.50	53.86	HOR3205	BLANDO	SIN RANURA
37	HO208C	4	7625	D824	58.50	53.85	HOR208C	BLANDO	SIN RANURA
37	HO208C	4	7625	D756	58.50	53.85	HOR208C	BLANDO	SIN RANURA
53	HO214D	2	7177	D227	54.00	53.85	HOR214D	BLANDO	SIN RANURA
53	HO214D	2	7578	D704	54.00	53.85	HOR214D	BLANDO	SIN RANURA
53	HO214D	2	9611	D2385	54.00	53.85	HOR214D	BLANDO	SIN RANURA
53	HO214D	2	78Y1	F565	54.00	53.85	HOR214D	BLANDO	SIN RANURA
53	HO214D	2	7Y09	F221	54.00	53.85	HOR214D	BLANDO	SIN RANURA
53	HO214D	2	9006	D1776	54.00	53.85	HOR214D	BLANDO	SIN RANURA
47	HO7500	2	8806	D1593	50.00	53.85	HOR7500	BLANDO	SIN RANURA
47	HO7500	2	71Y4	F450	50.00	53.85	HOR7500	BLANDO	SIN RANURA
48	HO900A	2	7767	D889	46.70	53.85	HOR900A	BLANDO	SIN RANURA
48	HO900C	2	7550	D670	49.40	53.85	HOR900C	DURO	SIN RANURA
55	HO70900	2	8671	D1471	47.30	53.85	HOR70900	BLANDO	SIN RANURA
49	HO209N	2	7Y01	F207	53.50	53.84	HOR209N	BLANDO	SIN RANURA
49	HO209N	2	8255	D1145	53.50	53.84	HOR209N	BLANDO	SIN RANURA
50	HO2900	2	775Y	F222	53.50	53.84	HOR2900	BLANDO	SIN RANURA
50	HO2900	2	7Y21	F253	53.50	53.84	HOR2900	BLANDO	SIN RANURA
51	HO209U	2	8301	D1184	47.95	53.83	HOR209U	BLANDO	SIN RANURA
50	HO2700	2	7782	D904	48.00	53.82	HOR2700	BLANDO	SIN RANURA
49	HO209X	2	723X	F027	53.50	53.81	HOR209X	BLANDO	SIN RANURA
48	HO212L	2	7293	D440	48.50	53.80	HOR212L	BLANDO	SIN RANURA
47	HO2108	2	8671	D1471	47.35	53.77	HOR2108	BLANDO	SIN RANURA
47	HO2108	2	7573	D465	47.35	53.77	HOR2108	BLANDO	SIN RANURA
49	HO2519	4	7697	D825	55.00	53.75	HOR2519	BLANDO	SIN RANURA

*Ø. = DIÁMETRO EXTERIOR

*h. = ALTURA

*CE. = CÓDIGO EQUIVALENTE

* TODOS LOS PISTONES INCLUYEN LIGA Y SILICÓN

FRENOS HO 2024-2025

19

PÁG.	CÓDIGO	UXV	BALATA	FMSI	h. ALTURA	Ø DIÁMETRO PISTÓN	REPUESTO	TIPO CUBREPOLVO	TIPO DE PISTÓN
52	HO2021	2	9081	D1852	47.90	53.73	HOR2021	BLANDO	SIN RANURA
54	HO214H	4	79W2	F308	59.00	52.00	HOR214H	BLANDO	SIN RANURA
54	HO214H	4	8383	D1268	59.00	52.00	HOR214H	BLANDO	SIN RANURA
35	HO3111	4	8748	D1540	58.00	51.97	HOR3111	BLANDO	SIN RANURA
35	HO3111	4	9070	D1842	58.00	51.97	HOR3111	BLANDO	SIN RANURA
35	HO3111	4	9071	D1540	58.00	51.97	HOR3111	BLANDO	SIN RANURA
35	HO3111	4	8383	D1699	58.00	51.97	HOR3111	BLANDO	SIN RANURA
30	HO2523	1	9254	D2024	50.50	51.93	HOR2523	DURO	SIN RANURA
27	HO211L	2	8741	D1532	57.00	51.90	HOR211L	DURO	SIN RANURA
27	HO211L	2	766X	F186	57.00	51.90	HOR211L	DURO	SIN RANURA
29	HO2506	2	8801	D1590	48.30	51.89	HOR2506	BLANDO	SIN RANURA
38	HO208R	2	7837	D934	56.00	51.83	HOR208R	BLANDO	SIN RANURA
38	HO208R	2	7838	D935	56.00	51.83	HOR208R	BLANDO	SIN RANURA
48	HO2502	2	7100	D244	46.22	51.05	HOR2502	BLANDO	SIN RANURA
51	HO2000	2	7704	D831	45.97	51.03	HOR2000	BLANDO	SIN RANURA
45	HO207W	2	7386	D507	45.97	51.03	HOR207W	BLANDO	SIN RANURA
53	HO2024	8	8419	D1303	31.00	51.00	HOR2024	BLANDO	SIN RANURA
51	HO209K	2	7153	D242	45.00	51.00	HOR209K	BLANDO	SIN RANURA
51	HO209S	2	78X3M	F065	57.00	51.00	HOR209S	BLANDO	SIN RANURA
48	HO212E	2	8253	D1142	44.50	51.00	HOR212E	BLANDO	SIN RANURA
48	HO212E	2	8258	D1148	44.50	51.00	HOR212E	BLANDO	SIN RANURA
48	HO212E	2	7X37	F138	44.50	51.00	HOR212E	BLANDO	SIN RANURA
48	HO212E	2	7Y02	F208	44.50	51.00	HOR212E	BLANDO	SIN RANURA
30	HO2518	2	9167	D1942	51.00	51.00	HOR2518	BLANDO	SIN RANURA
30	HO2520	4	9418	D2173	30.00	51.00	HOR2520	DURO	SIN RANURA
30	HO2522	2	9419	D2174	53.30	51.00	HOR2522	BLANDO	DE ROSCA
43	HO3300	2	9159	D1935	45.00	51.00	HOR3300	BLANDO	SIN RANURA
47	HO900J	2	7332	D452	43.20	51.00	HOR900J	BLANDO	SIN RANURA
47	HO900J	2	7180	D277	43.20	51.00	HOR900J	BLANDO	SIN RANURA
38	HO208G	4	7915	D1011	56.45	50.99	HOR208G	DURO	SIN RANURA
44	HO207N	4	7918	D1015	52.30	50.98	HOR207N	DURO	SIN RANURA
44	HO207N	4	7918	D1063	52.30	50.98	HOR207N	DURO	SIN RANURA
38	HO208H	4	7916	D1012	52.30	50.98	HOR208H	DURO	SIN RANURA
36	HO213I	4	7861	D962	52.38	50.96	HOR213I	DURO	SIN RANURA
48	HO2200	2	7104	D177	43.98	50.96	HOR2200	BLANDO	SIN RANURA
36	HO213J	2	7862	D963	56.38	50.95	HOR213J	DURO	SIN RANURA
48	HO900B	2	7219	D466	44.63	50.94	HOR900B	BLANDO	SIN RANURA
27	HO211I	4	7653	D785	57.00	50.92	HOR211I	DURO	SIN RANURA
27	HO211I	4	7652	D784	57.00	50.92	HOR211I	DURO	SIN RANURA
38	HO208F	4	7584	D711	50.00	50.90	HOR208F	DURO	SIN RANURA
39	HO210F	4	7532	D652	48.00	50.90	HOR210F	DURO	SIN RANURA
39	HO210F	4	7576	D702	48.00	50.90	HOR210F	DURO	SIN RANURA
28	HO211W	4	8472	D1363	53.00	50.90	HOR211W	DURO	SIN RANURA
28	HO211W	4	7997	D1092	53.00	50.90	HOR211W	DURO	SIN RANURA
28	HO211W	4	8930	D1707	53.00	50.90	HOR211W	DURO	SIN RANURA
28	HO211Z	2	8312	D1194	53.10	50.90	HOR211Z	DURO	SIN RANURA
34	HO3100	4	8508	D1400	57.30	50.90	HOR3100	DURO	SIN RANURA
35	HO3103	4	8800	D1589	53.40	50.90	HOR3103	DURO	SIN RANURA
54	HO70603	2	8810	D1595	45.00	50.90	HOR70603	BLANDO	SIN RANURA

INDICE DE PISTÓN Y REPUESTO



PÁG.	CÓDIGO	UXV	BALATA	FMSI	h. ALTURA	Ø DIÁMETRO PISTÓN	REPUESTO	TIPO CUBREPOLVO	TIPO DE PISTÓN
54	HO70603	2	8751	D1543	45.00	50.90	HOR70603	BLANDO	SIN RANURA
55	HO70800	2	82Y2	F564	45.00	50.90	HOR70800	DURO	SIN RANURA
38	HO208J	4	7997	D1022	53.47	50.85	HOR208J	BLANDO	SIN RANURA
43	HO207	2	780	D37	39.40	50.69	HOR207	N/A	SIN RANURA
35	HO3109	2	8956	D1731	44.70	50.68	HOR3109	BLANDO	SIN RANURA
45	HO2401	4	8403	D1509	55.40	50.65	HOR2401	DURO	SIN RANURA
45	HO2401	4	8403	D1286	55.40	50.65	HOR2401	DURO	SIN RANURA
38	HO208L	4	8268	D1158	50.93	50.62	HOR208L	DURO	SIN RANURA
46	HO209C	2	7439	D560	44.00	50.61	HOR209C	BLANDO	SIN RANURA
49	HO2508A	4	8924	D1700	53.70	50.60	HOR2508A	DURO	SIN RANURA
32	HO216W	4	7881	D974	63.00	50.53	HOR216W	BLANDO	SIN RANURA
28	HO211N	2	8290	D1176	55.00	48.04	HOR211N	DURO	SIN RANURA
28	HO211N	2	7Y03	F209	55.00	48.04	HOR211N	DURO	SIN RANURA
53	HO2025	8	7877	D976	31.00	48.00	HOR2025	BLANDO	SIN RANURA
53	HO2025	8	7636	D772	31.00	48.00	HOR2025	BLANDO	SIN RANURA
43	HO207B	2	7155	D275	48.60	48.00	HOR207B	BLANDO	SIN RANURA
43	HO207B	2	7389	D510	48.60	48.00	HOR207B	BLANDO	SIN RANURA
44	HO207H	2	7388	D509	45.00	48.00	HOR207H	BLANDO	SIN RANURA
38	HO208I	2	7973	D1068	53.40	48.00	HOR208I	BLANDO	SIN RANURA
46	HO209G	2	7331	D451	48.50	48.00	HOR209G	BLANDO	SIN RANURA
46	HO209G	2	8332	D1202	48.50	48.00	HOR209G	BLANDO	SIN RANURA
46	HO209G	2	8322	D1202	48.50	48.00	HOR209G	BLANDO	SIN RANURA
51	HO209J	2	7487	D606	48.50	48.00	HOR209J	BLANDO	SIN RANURA
31	HO216I	2	7760	D883	48.50	48.00	HOR216I	BLANDO	SIN RANURA
31	HO216K	2	7596	D729	49.00	48.00	HOR216K	BLANDO	SIN RANURA
46	HO2407	4	8835	D1487	60.00	48.00	HOR2407	DURO	SIN RANURA
46	HO2407	4	8432	D1318	60.00	48.00	HOR2407	DURO	SIN RANURA
46	HO2407	4	7Y46	F338	60.00	48.00	HOR2407	DURO	SIN RANURA
36	HO3113	2	8332	D2186	51.00	48.00	HOR3113	DURO	SIN RANURA
36	HO3114	4	8932	D1709	51.00	48.00	HOR3114	BLANDO	SIN RANURA
48	HO900E	2	7291	D402	45.00	48.00	HOR900E	DURO	SIN RANURA
46	HO2411	4	8719	D1510	44.70	48.00	HOR2411	BLANDO	SIN RANURA
30	HO2511	4	9600	D2371	53.00	48.00	HOR2511	BLANDO	SIN RANURA
43	HO3206	4	9456	D2216	45.00	48.00	HOR3206	BLANDO	SIN RANURA
44	HO207P	2	7945	D1041	52.37	47.99	HOR207P	DURO	SIN RANURA
28	HO211X	4	8410	D1169	52.20	47.96	HOR211X	DURO	SIN RANURA
28	HO211X	4	8282	D1169	52.20	47.96	HOR211X	DURO	SIN RANURA
54	HO214K	4	8767	D1555	52.00	47.95	HOR214K	DURO	SIN RANURA
37	HO213T	2	8390	D1274	49.53	47.94	HOR213T	BLANDO	SIN RANURA
53	HO214G	2	7242	D350	53.09	47.94	HOR214G	BLANDO	SIN RANURA
49	HO209P	2	76X3	F134	50.50	47.93	HOR209P	DURO	SIN RANURA
39	HO210B	2	7565	D690	49.70	47.93	HOR210B	DURO	SIN RANURA
39	HO210B	2	7610	D674	49.70	47.93	HOR210B	DURO	SIN RANURA
39	HO210B	2	7545	D667	49.70	47.93	HOR210B	DURO	SIN RANURA
41	HO217J	2	8660	D1460	55.50	47.93	HOR217J	DURO	SIN RANURA
41	HO217J	2	769X	F174	55.50	47.93	HOR217J	DURO	SIN RANURA
29	HO216B	2	7563	D688	49.00	47.91	HOR216B	BLANDO	SIN RANURA
29	HO216B	2	72X1	F038	49.00	47.91	HOR216B	BLANDO	SIN RANURA
29	HO216B	2	72X2	D688	49.00	47.91	HOR216B	BLANDO	SIN RANURA

*Ø. = DIÁMETRO EXTERIOR

*h. = ALTURA

*CE. = CÓDIGO EQUIVALENTE

* TODOS LOS PISTONES INCLUYEN LIGA Y SILICÓN

FRENOS HO 2024-2025

21

PÁG.	CÓDIGO	UXV	BALATA	FMSI	h. ALTURA	Ø DIÁMETRO PISTÓN	REPUESTO	TIPO CUBREPOLVO	TIPO DE PISTÓN
43	HO207F	2	71X4	F051	53.20	47.90	HOR207F	BLANDO	SIN RANURA
43	HO207F	2	8256	D1579	53.20	47.90	HOR207F	BLANDO	SIN RANURA
43	HO207F	2	8256	D1146	53.20	47.90	HOR207F	BLANDO	SIN RANURA
39	HO210C	4	7558	D679	49.00	47.90	HOR210C	DURO	SIN RANURA
39	HO210C	4	7834	D931	49.00	47.90	HOR210C	DURO	SIN RANURA
53	HO214C	2	7183	D569	52.40	47.90	HOR214C	BLANDO	SIN RANURA
53	HO214C	2	7183	D280	52.40	47.90	HOR214C	BLANDO	SIN RANURA
53	HO214C	2	7209	D280	52.40	47.90	HOR214C	BLANDO	SIN RANURA
53	HO214C	2	7569	D694	52.40	47.90	HOR214C	BLANDO	SIN RANURA
53	HO214C	2	8868	D1641	52.40	47.90	HOR214C	BLANDO	SIN RANURA
45	HO2406	4	8834	D1622	60.00	47.90	HOR2406	BLANDO	SIN RANURA
45	HO2406	4	8383	D1268	60.00	47.90	HOR2406	BLANDO	SIN RANURA
35	HO3102	4	8655	D1455	55.60	47.90	HOR3102	DURO	SIN RANURA
35	HO3102	4	8856	D1904	55.60	47.90	HOR3102	DURO	SIN RANURA
35	HO3102	4	8856	D1629	55.60	47.90	HOR3102	DURO	SIN RANURA
40	HO210R	2	8214	D1109	47.25	47.87	HOR210R	DURO	SIN RANURA
40	HO210R	2	7907	D881	47.25	47.87	HOR210R	DURO	SIN RANURA
34	HO212Z	4	7660	D942	50.57	47.86	HOR212Z	DURO	SIN RANURA
34	HO212Z	4	7660	D1498	50.57	47.86	HOR212Z	DURO	SIN RANURA
34	HO212Z	4	7660	D790	50.57	47.86	HOR212Z	DURO	SIN RANURA
41	HO217I	2	7545	D667	47.25	47.86	HOR217I	DURO	SIN RANURA
33	HO212P	2	7945	D1087	52.37	47.85	HOR212P	DURO	SIN RANURA
33	HO212P	2	7985	D1080	52.37	47.85	HOR212P	DURO	SIN RANURA
33	HO212P	2	8297	D1181	52.37	47.85	HOR212P	DURO	SIN RANURA
33	HO212S	4	7852	D953	49.67	47.85	HOR212S	DURO	SIN RANURA
33	HO212S	4	7898	D997	49.67	47.85	HOR212S	DURO	SIN RANURA
33	HO212R	2	7863	D981	47.25	47.83	HOR212R	DURO	SIN RANURA
39	HO210H	4	7674	D803	50.00	47.80	HOR210H	BLANDO	SIN RANURA
33	HO212C	2	7661	D791	47.35	47.80	HOR212C	DURO	SIN RANURA
37	HO213Z	4	7846	D945	59.00	47.53	HOR213Z	BLANDO	SIN RANURA
47	HO2112	4	8396	D1723	48.60	47.50	HOR2112	BLANDO	SIN RANURA
41	HO217K	4	8441	D1329	46.00	47.50	HOR217K	DURO	SIN RANURA
30	HO2512	4	8523	D1411	53.50	47.50	HOR2512	DURO	SIN RANURA
41	HO217L	4	8715	D1508	51.00	47.46	HOR217L	DURO	SIN RANURA
44	HO207T	4	8310	D1191	51.10	47.38	HOR207T	BLANDO	SIN RANURA
44	HO207T	4	776X	F198	51.10	47.38	HOR207T	BLANDO	SIN RANURA
45	HO2402	4	7703	D830	50.85	46.23	HOR2402	BLANDO	SIN RANURA
45	HO2402	4	8200	D1900	50.85	46.23	HOR2402	BLANDO	SIN RANURA
45	HO2402	4	8200	D1094	50.85	46.23	HOR2402	BLANDO	SIN RANURA
37	HO213W	4	8729	D1520	47.00	45.95	HOR213W	BLANDO	SIN RANURA
37	HO213W	4	7X35	F278	47.00	45.95	HOR213W	BLANDO	SIN RANURA
35	HO3112	4	9071	D1540	58.00	45.94	HOR3112	DURO	SIN RANURA
35	HO3112	4	9070	D1842	58.00	45.94	HOR3112	DURO	SIN RANURA
38	HO208E	4	7706	D833	51.00	45.85	HOR208E	DURO	SIN RANURA
38	HO208E	4	7532	D652	51.00	45.85	HOR208E	DURO	SIN RANURA
49	HO209E	2	7532	D652	51.00	45.85	HOR209E	DURO	SIN RANURA
31	HO216L	4	7593	D726	52.00	45.85	HOR216L	DURO	SIN RANURA
28	HO211R	4	7943	D1039	53.30	45.47	HOR211R	DURO	SIN RANURA
53	HO2026	2	7487	D606	48.50	45.35	HOR2026	BLANDO	SIN RANURA

INDICE DE PISTÓN Y REPUESTO



PÁG.	CÓDIGO	UXV	BALATA	FMSI	h. ALTURA	Ø DIÁMETRO PISTÓN	REPUESTO	TIPO CUBREPOLVO	TIPO DE PISTÓN
52	HO2014	4	7298	D502	28.69	45.32	HOR2014	BLANDO	SIN RANURA
52	HO2016	8	7877	D976	31.30	45.30	HOR2016	BLANDO	SIN RANURA
52	HO2016	8	8636	D1324	31.30	45.30	HOR2016	BLANDO	SIN RANURA
52	HO2016	8	8776	D1567	31.30	45.30	HOR2016	BLANDO	SIN RANURA
30	HO2524	1	9034	D1802	34.40	45.30	HOR2524	DURO	SIN RANURA
50	HO2702	2	7742	D867	45.70	45.30	HOR2702	BLANDO	SIN RANURA
47	HO2110	2	7994	D1521	53.80	45.29	HOR2110	BLANDO	SIN RANURA
47	HO2110	2	7994	D1089	53.80	45.29	HOR2110	BLANDO	SIN RANURA
47	HO2110	2	7994	D2133	53.80	45.29	HOR2110	BLANDO	SIN RANURA
47	HO2110	2	7994	D1479	53.80	45.29	HOR2110	BLANDO	SIN RANURA
42	HO3200	4	8377	D1258	53.00	45.29	HOR3200	BLANDO	SIN RANURA
42	HO3200	4	8384	D1258	53.00	45.29	HOR3200	BLANDO	SIN RANURA
53	HO2023	2	8420	D1304	52.00	45.00	HOR2023	BLANDO	SIN RANURA
49	HO2800	4	7848	D949	56.50	45.00	HOR2800	DURO	SIN RANURA
46	HO2412	2	9599	D2370	50.00	45.00	HOR2412	BLANDO	SIN RANURA
43	HO3206	4	8918	D1691	48.00	45.00	HOR3206	BLANDO	SIN RANURA
38	HO208K	4	7975	D1070	52.80	44.97	HOR208K	DURO	SIN RANURA
42	HO217W	2	7675	D804	52.80	44.97	HOR217W	BLANDO	SIN RANURA
30	HO2515	2	8448	D1337	49.20	44.92	HOR2515	BLANDO	SIN RANURA
30	HO2515	2	8381	D1264	49.20	44.92	HOR2515	BLANDO	SIN RANURA
30	HO2515	2	8401	D1284	49.20	44.92	HOR2515	BLANDO	SIN RANURA
30	HO2515	2	8332	D1202	49.20	44.92	HOR2515	BLANDO	SIN RANURA
30	HO2515	2	7781	D903	49.20	44.92	HOR2515	BLANDO	SIN RANURA
30	HO2515	2	8201	D1097	49.20	44.92	HOR2515	BLANDO	SIN RANURA
31	HO216H	4	7653	D785	52.70	44.90	HOR216H	DURO	SIN RANURA
31	HO216H	4	7652	D784	52.70	44.90	HOR216H	DURO	SIN RANURA
31	HO216H	4	7759	D882	52.70	44.90	HOR216H	DURO	SIN RANURA
46	HO2409	2	77W3	F521	50.50	44.90	HOR2409	BLANDO	SIN RANURA
46	HO2409	2	8200	D1911	50.50	44.90	HOR2409	BLANDO	SIN RANURA
35	HO3101	4	8508	D1400	59.20	44.85	HOR3101	DURO	SIN RANURA
38	HO208N	2	7673	D802	47.46	44.83	HOR208N	DURO	SIN RANURA
40	HO210W	4	7949	D1046	47.43	44.80	HOR210W	DURO	SIN RANURA
37	HO213S	2	7865	D1077	56.70	44.79	HOR213S	DURO	SIN RANURA
32	HO216T	2	7881	D974	56.50	44.35	HOR216T	BLANDO	SIN RANURA
32	HO216T	2	7875	D974	56.50	44.35	HOR216T	BLANDO	SIN RANURA
39	HO210G	4	7626	D757	56.50	44.34	HOR210G	BLANDO	SIN RANURA
44	HO207G	4	7566	D691	52.50	44.33	HOR207G	BLANDO	SIN RANURA
28	HO211T	4	7881	D974	54.38	44.32	HOR211T	BLANDO	SIN RANURA
28	HO211T	4	7707	D975	54.38	44.32	HOR211T	BLANDO	SIN RANURA
29	HO2510	2	8906	D1677	45.00	44.30	HOR2510	DURO	SIN RANURA
44	HO207I	4	7910	D691	52.00	44.27	HOR207I	BLANDO	SIN RANURA
44	HO207I	4	7566	D691	52.00	44.27	HOR207I	BLANDO	SIN RANURA
45	HO2400A	4	7566	D855	52.00	44.25	HOR2400A	BLANDO	SIN RANURA
45	HO2400A	4	7910	D855	52.00	44.25	HOR2400A	BLANDO	SIN RANURA
50	HO2701	2	7743	D868	45.50	44.22	HOR2701	BLANDO	SIN RANURA
53	HO214A	2	7031	D96	53.80	43.90	HOR214A	BLANDO	SIN RANURA
37	HO213U	4	8259	D1149	32.00	43.79	HOR213U	DURO	SIN RANURA
37	HO213U	4	7965	D1058	32.00	43.79	HOR213U	DURO	SIN RANURA
40	HO210X	2	7674	D803	47.10	43.76	HOR210X	DURO	SIN RANURA

*Ø. = DIÁMETRO EXTERIOR

*h. = ALTURA

*CE. = CÓDIGO EQUIVALENTE

* TODOS LOS PISTONES INCLUYEN LIGA Y SILICÓN

FRENOS HO 2024-2025

23

PÁG.	CÓDIGO	UXV	BALATA	FMSI	h. ALTURA	Ø DIÁMETRO PISTÓN	REPUESTO	TIPO CUBREPOLVO	TIPO DE PISTÓN
52	HO2006	4	7357	D697	49.50	42.80	HOR2006	BLANDO	SIN RANURA
48	HO900F	4	7739	D864	49.00	42.80	HOR900F	BLANDO	SIN RANURA
48	HO900F	4	7739	D1104	49.00	42.80	HOR900F	BLANDO	SIN RANURA
48	HO900F	4	7739	D1099	49.00	42.80	HOR900F	BLANDO	SIN RANURA
50	HO207TG	4	7298	D436	28.00	42.79	HOR207TG	BLANDO	SIN RANURA
50	HO207TG	4	7549	D436	28.00	42.79	HOR207TG	BLANDO	SIN RANURA
50	HO207TG	4	7069	D137	28.00	42.79	HOR207TG	BLANDO	SIN RANURA
43	HO207D	4	7228	D333	48.00	42.77	HOR207D	BLANDO	SIN RANURA
43	HO207D	4	7880	D929	48.00	42.77	HOR207D	BLANDO	SIN RANURA
52	HO2015	8	7877	D976	31.20	42.76	HOR2015	BLANDO	SIN RANURA
52	HO2015	8	7639	D772	31.20	42.76	HOR2015	BLANDO	SIN RANURA
49	HO209F	2	7412	D530	45.00	42.74	HOR209F	BLANDO	SIN RANURA
44	HO207L	2	7784	D905	45.00	42.73	HOR207L	BLANDO	SIN RANURA
47	HO2111	2	8697	D1724	44.70	42.73	HOR2111	BLANDO	SIN RANURA
45	HO2405	2	8773	D1565	49.00	42.70	HOR2405	DURO	SIN RANURA
45	HO2405	2	8523	D1565	49.00	42.70	HOR2405	DURO	SIN RANURA
30	HO2521	2	9041	D1806	44.60	42.70	HOR2521	DURO	SIN RANURA
50	HO2902	1	7602	D733	46.30	42.70	HOR2902	BLANDO	SIN RANURA
29	HO2509	4	8906	D1677	54.00	42.43	HOR2509	DURO	SIN RANURA
28	HO211P	4	7794	D913	48.50	42.00	HOR211P	DURO	SIN RANURA
36	HO213N	4	7963	D1057	53.07	41.91	HOR213N	DURO	SIN RANURA
36	HO213N	4	7963	D1676	53.07	41.91	HOR213N	DURO	SIN RANURA
33	HO212J	2	7734	264	50.00	41.90	HOR212J	DURO	SIN RANURA
36	HO213K	2	7899	D998	52.46	41.90	HOR213K	DURO	SIN RANURA
31	HO216G	4	7265	D376	59.00	41.80	HOR216G	DURO	SIN RANURA
32	HO216Z	2	7460	D580	45.30	41.15	HOR216Z	BLANDO	SIN RANURA
32	HO216Z	2	7586	D580	45.30	41.15	HOR216Z	BLANDO	SIN RANURA
50	HO2903	2	7681	D808	51.00	40.96	HOR2903	BLANDO	DE ROSCA
52	HO2022	2	8500	D1391	45.80	40.40	HOR2022	BLANDO	SIN RANURA
53	HO214B	2	755	D21	29.00	39.95	HOR214B	BLANDO	SIN RANURA
53	HO214B	2	755	D30	29.00	39.95	HOR214B	BLANDO	SIN RANURA
54	HO70606	2	9280	D2050	46.60	38.10	HOR70606	BLANDO	SIN RANURA
54	HO70606	2	9283	D2098	46.60	38.10	HOR70606	BLANDO	SIN RANURA
48	HO900D	2	7688	D863	49.20	38.05	HOR900D	BLANDO	SIN RANURA
48	HO900D	2	7688	D813	49.20	38.05	HOR900D	BLANDO	SIN RANURA
51	HO2003	2	8332	D1212	40.00	38.00	HOR2003	BLANDO	SIN RANURA
52	HO2019	2	8332	D1212	44.40	38.00	HOR2019	BLANDO	SIN RANURA
47	HO2109	2	7418	D1086	46.20	38.00	HOR2109	BLANDO	SIN RANURA
47	HO2109	2	7418	D536	46.20	38.00	HOR2109	BLANDO	SIN RANURA
47	HO2109	2	7418	D537	46.20	38.00	HOR2109	BLANDO	SIN RANURA
53	HO214F	2	7234	D340	51.00	38.00	HOR214F	BLANDO	DE ROSCA
53	HO214F	2	7335	D340	51.00	38.00	HOR214F	BLANDO	DE ROSCA
53	HO214F	2	9044	D1809	51.00	38.00	HOR214F	BLANDO	DE ROSCA
53	HO214F	2	9085	D1857	51.00	38.00	HOR214F	BLANDO	DE ROSCA
53	HO214F	2	8213	D1348	51.00	38.00	HOR214F	BLANDO	DE ROSCA
53	HO214F	2	8213	D1108	51.00	38.00	HOR214F	BLANDO	DE ROSCA
53	HO214F	2	8463	D1423	51.00	38.00	HOR214F	BLANDO	DE ROSCA
53	HO214F	2	9085	D1915	51.00	38.00	HOR214F	BLANDO	DE ROSCA
53	HO214F	2	9069	D1841	51.00	38.00	HOR214F	BLANDO	DE ROSCA

INDICE DE PISTÓN Y REPUESTO



PÁG.	CÓDIGO	UXV	BALATA	FMSI	h. ALTURA	Ø DIÁMETRO PISTÓN	REPUESTO	TIPO CUBREPOLVO	TIPO DE PISTÓN
53	HO214F	2	9146	D1921	51.00	38.00	HOR214F	BLANDO	DE ROSCA
53	HO214F	2	9068	D1840	51.00	38.00	HOR214F	BLANDO	DE ROSCA
53	HO214F	2	9190	D1965	51.00	38.00	HOR214F	BLANDO	DE ROSCA
53	HO214F	2	8422	D1307	51.00	38.00	HOR214F	BLANDO	DE ROSCA
29	HO216D	2	7387	D508	42.00	38.00	HOR216D	BLANDO	DE ROSCA
32	HO216X	2	7387	D814	45.10	38.00	HOR216X	BLANDO	SIN RANURA
46	HO2410	2	8206	D1100	51.00	38.00	HOR2410	BLANDO	SIN RANURA
46	HO2410	2	8218	D1114	51.00	38.00	HOR2410	BLANDO	SIN RANURA
46	HO2410	2	7978	D1073	51.00	38.00	HOR2410	BLANDO	SIN RANURA
46	HO2410	2	8204	D1101	51.00	38.00	HOR2410	BLANDO	SIN RANURA
42	HO3202	2	8837	D1624	47.00	38.00	HOR3202	BLANDO	DE ROSCA
55	HO70612	2	7335	D340	49.00	38.00	HOR70612	BLANDO	DE ROSCA
55	HO70612	2	8428	D1813	49.00	38.00	HOR70612	BLANDO	DE ROSCA
55	HO70612	2	9283	D2098	49.00	38.00	HOR70612	BLANDO	DE ROSCA
55	HO70612	2	8614	D1295	49.00	38.00	HOR70612	BLANDO	DE ROSCA
29	HO216E	2	7387	D814	50.00	37.98	HOR216E	BLANDO	SIN RANURA
29	HO216E	2	7387	D698	50.00	37.98	HOR216E	BLANDO	SIN RANURA
29	HO216E	2	7574	D699	50.00	37.98	HOR216E	BLANDO	SIN RANURA
34	HO213C	2	7438	D641	48.50	35.93	HOR213C	DURO	SIN RANURA
34	HO213C	2	7438A	D559	48.50	35.93	HOR213C	DURO	SIN RANURA
34	HO213C	2	7438	D759	48.50	35.93	HOR213C	DURO	SIN RANURA
34	HO213C	2	7438B	D641	48.50	35.93	HOR213C	DURO	SIN RANURA
36	HO213L	2	7865	D1077	56.60	35.91	HOR213L	DURO	SIN RANURA
44	HO207J	2	7784	D905	45.00	34.80	HOR207J	BLANDO	SIN RANURA
44	HO207J	2	8501	D1393	45.00	34.80	HOR207J	BLANDO	SIN RANURA
45	HO207Z	1	8405	D1288	45.00	34.80	HOR207Z	BLANDO	SIN RANURA
45	HO207Z	1	8501	D1393	45.00	34.80	HOR207Z	BLANDO	SIN RANURA
34	HO212U	2	7940	D1037	45.00	34.75	HOR212U	BLANDO	SIN RANURA
46	HO2408	2	8778	D1569	47.00	34.00	HOR2408	BLANDO	SIN RANURA
46	HO2408	2	7533	D540	47.00	34.00	HOR2408	BLANDO	SIN RANURA
46	HO2408	2	7418	D537	47.00	34.00	HOR2408	BLANDO	SIN RANURA
46	HO2408	2	7696	D823	47.00	34.00	HOR2408	BLANDO	SIN RANURA
46	HO2408	2	7883	D886	47.00	34.00	HOR2408	BLANDO	SIN RANURA
46	HO2408	2	9237	D2007	47.00	34.00	HOR2408	BLANDO	SIN RANURA
55	HO70610	2	8428	D1812	46.00	34.00	HOR70610	BLANDO	DE ROSCA
55	HO70610	2	8428	D1544	46.00	34.00	HOR70610	BLANDO	DE ROSCA
55	HO70611	2	8428	D1813	47.00	34.00	HOR70611	BLANDO	DE ROSCA
34	HO213A	2	7303	D415	49.00	33.92	HOR213A	DURO	SIN RANURA
50	HO207TC	4	7298	D436	28.50	33.90	HOR207TC	BLANDO	SIN RANURA
50	HO207TC	4	7069	D137	28.50	33.90	HOR207TC	BLANDO	SIN RANURA
54	HO70608	2	8506	D1398	46.99	33.90	HOR70608	BLANDO	SIN RANURA
54	HO70605	2	7688	D813	45.10	33.87	HOR70605	BLANDO	SIN RANURA
54	HO70605	2	7767	523	45.10	33.87	HOR70605	BLANDO	SIN RANURA
52	HO2020	2	7955	D1051	47.30	31.82	HOR2020	BLANDO	SIN RANURA
54	HO70609	2	8267	D1157	46.80	30.83	HOR70609	BLANDO	SIN RANURA
43	HO3207	2	7338	D458	45.50	30.00	HOR3207	BLANDO	DE ROSCA
43	HO3207	2	7464	D584	45.50	30.00	HOR3207	BLANDO	DE ROSCA
47	HO900H	2	7443	D564	45.00	30.00	HOR900H	BLANDO	CON RANURA
47	HO900H	2	7418	D536	45.00	30.00	HOR900H	BLANDO	CON RANURA

*Ø. = DIÁMETRO EXTERIOR

*h. = ALTURA

*CE. = CÓDIGO EQUIVALENTE

* TODOS LOS PISTONES INCLUYEN LIGA Y SILICÓN

FRENOS HO 2024-2025

25



PISTÓN CON RANURA
TIPO (A)



PISTÓN SIN RANURA
TIPO (B)



PISTÓN DE ROSCA
TIPO (C)



REPUESTO BLANDO TIPO (A)



REPUESTO DURO TIPO (B)

GUÍA DE MEDIDA PARA REPUESTO DE CALIPER

PASO 3 ENSAMBLE

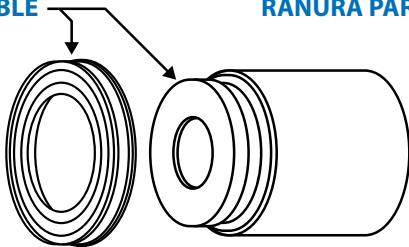

PASO 1- Lubricar la "RANURA PARA LIGA" con el lubricante de SILICÓN incluido en su kit de pistón HO.

PASO 2- Introducir la liga en la ranura señalada.

PASO 3- Ensamblar el cubrepolvo en el pistón.

PASO 4- Introducir el pistón en el caliper.

NOTA: Si el repuesto de su pistón es blando se incluirá un seguro circular que deberá ser instalado por la parte de afuera del cubrepolvo una vez instalado en el caliper.

PASO 2 RANURA PARA LIGA

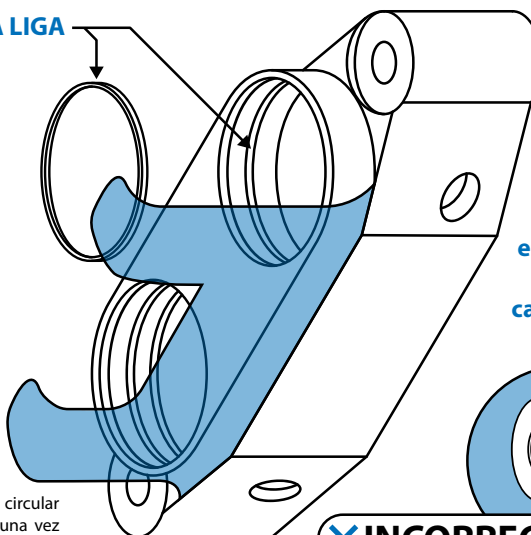

HO TIPS

Recuerda que la forma correcta de medir la liga, es sobre la ranura designada en el caliper y **NO** sobre el pistón.

X INCORRECTO

PISTONES PARA CALIPER



CHEVROLET / JEEP / BUICK / ISUZU / DODGE / PONTIAC / GMC / AM GENERAL

HO211 Ø 74.50mm
h. 49.00mm
HOR211

CHEVROLET C10 (75-86), C20 (76-86), C30 (75-81) 728A D52, JEEP CHEROKEE (80-86), WAGONEER (80-86) 728 D52, RUEDA DELANTERA

HO211A Ø 63.44mm
h. 43.00mm
HOR211A

BUICK CENTURY (90-96) 7136 D215, REGAL (82-87) 7070A D138, RIVIERA (82-85) 7070A D202, CHEVROLET MALIBU (78-81), MONTECARLO (78-81) 7070A D138, S10 (90-92) 7070A D202, GMC JIMMY (82-94) 7070A D154, RUEDA DELANTERA

HO211B Ø 56.90mm
h. 44.00mm
HOR211B

BUICK CENTURY (84-89) 7070C D183, CHEVROLET CAVALIER (92-95) 7385 D506, CELEBRITY (82-90), CITATION (81-85) 7070C D183, RUEDA DELANTERA

HO211C Ø 79.92mm
h. 54.90mm
HOR211C

CHEVROLET C2500 (88-00), C3500 (94-00), TAHOE (96-00) 7260 D370, RUEDA DELANTERA

HO211D Ø 74.50mm
h. 54.70mm
HOR211D

CHEVROLET ASTRO (90-02), C1500 (91-99), C20 (76-86), C2500 (88-00), CHEVY VAN (94-02), EXPRESS 1500 (96-02), SILVERADO 2500 (86-95), C1500 SUBURBAN (92-99), K2500 (89-95), TAHOE (00), GMC SAFARI (90-02), SAVANA 1500 (01-02), 2500 (96-02), DODGE RAM 1500 (94-98), RAM 2500 (99-01) 7259 D369, RUEDA DELANTERA

HO211E Ø 73.00mm
h. 70.80mm
HOR211E

GMC C6000 (83-90) 7141 D224, 7818 D225, 7808 D225, CHEVROLET C7 (83-90) 7808 D225, RUEDA DEL Y TRA

HO211G Ø 60.43mm
h. 52.00mm
HOR211G

CHEVROLET MALIBU (98-06) 7735 D752, 7620 D752, PONTIAC GRAND AM (99-05) 7620 D752, RUEDA DELANTERA

HO211H Ø 59.88mm
h. 57.00mm
HOR211H

CHEVROLET SILVERADO 2500 HD (01-07), 3500 HD (07-10), EXPRESS 1500 (03-05), EXPRESS 2500 (03-05), 3500 (03-05), GMC SIERRA 1500 HD (01-03), 2500 HD (01-07), 3500 (02-05) 7652 D784, RUEDA DELANTERA

HO211I Ø 50.92mm
h. 57.00mm
HOR211I

AM GENERAL HUMMER H2 (02-06) CHEVROLET ASTRO (03-05), AVALANCHE 1500 (02-05) 7653 D785, 2500 (02-06) 7652 D784, C2500 (92-97), CHEYENNE 2500 (01-02) 7653 D785, SILVERADO 1500 (99-05) 7652 D784, 7653 D785, GMC SAVANA 1500 (03-08), SIERRA 1500 (05-07), DODGE RAM 4000 (01-05) 7653 D785, RUEDA DEL Y TRA

HO211J Ø 56.88mm
h. 55.00mm
HOR211J

CHEVROLET ASTRA ABS (00-07), ZAFIRA (02-06) 8252 D1141, 768 F185, RUEDA DELANTERA

HO211K Ø 63.38mm
h. 56.30mm
HOR211K

CHEVROLET C600 (82-84), KODIAK (97-01) 7807 D224, RUEDA DEL Y TRA

HO211L Ø 51.90mm
h. 57.00mm
HOR211L

CHEVROLET ASTRA (00-05) 766X F186, 8741 D1532 RUEDA DELANTERA

*Ø. = DIÁMETRO EXTERIOR
*h. = ALTURA
*CE. = CÓDIGO EQUIVALENTE

* TODOS LOS PISTONES INCLUYEN LIGA Y SILICÓN

FRENOS HO 2024-2025

PISTONES PARA CALIPER

CHEVROLET / PONTIAC / GREAT WALL / ISUZU / GMC / FORD / CADILLAC / BUICK / DODGE

HO211M Ø 56.85mm
h. 51.00mm
HOR211M

CHEVROLET CAVALIER (96-05) 7554 D673, **PONTIAC GRAND AM (91-98)** 7385 D506, **SUNFIRE (95-03)** 7554 D673, 7385 D506, **RUEDA DELANTERA**

HO211N Ø 48.04mm
h. 55.00mm
HOR211N

CHEVROLET CORSA (02-08) **TORNADO (04-16)** 8290 D1176, 7Y03 F209, **RUEDA DELANTERA**

HO211P Ø 42.00mm
h. 48.50mm
HOR211P

CHEVROLET EQUINOX (05-07) **PONTIAC TORRENT (06-08)** 7794 D913, **RUEDA DELANTERA**

HO211R Ø 45.47mm
h. 53.30mm
HOR211R

CHEVROLET CANYON (04-08), COLORADO (04-09), DMAX (04-08) **GREAT WALL HAVAL (05-10), GREAT WALL HOOVER (07-10), ISUZU I350 (05-06), ISUZU I280 (05-06)** 7943 D1039, **RUEDA DELANTERA**

HO211S Ø 59.90mm
h. 58.92mm
HOR211S

EXPRESS 1500 (02-10), SIERRA 1500 (99-06) 8454 D784, **F250 (05-12), F350 (06-09)** 7974 D1069, **SILVERADO 2500 (04-10)** 7653 D785, **SILVERADO 3500 (01-10)** 8454 D784, **RUEDA TRASERA**

HO211T Ø 44.32mm
h. 54.38mm
HOR211T

CADILLAC ESCALADE (03-06), CHEVROLET AVALANCHE1500 (03-05) 7881 D974, **SUBURBAN1500 (03-06)** 7707 D975, **GMC YUKON XL 1500 (02-06)** 7881 D974, **RUEDA TRASERA**

HO211U Ø 63.70mm
h. 55.78mm
HOR211U

CHEVROLET VENTURE (02-05) **PONTIAC AZTEK (01-05), MONTANA (02-04)** 7720 D844, **RUEDA DELANTERA**

HO211W Ø 50.90mm
h. 53.00mm
HOR211W

CADILLAC ESCALADE (08-20) 8472 D1363, **CHEVROLET AVALANCHE (07-13)** 7997 D1092, 8472 D1363, **CHEYENNE (11-13), EXPRESS 1500 (09-14)** 8472 D1363, **SILVERADO 1500 (07-18)** 8472 D1363, 7997 D1092, **SUBURBAN (15-20)** 8472 D1363, 8930 D1707, **TAHOE (07-20)** 8472 D1363, 7997 D1092, **GMC SIERRA 1500 (05-18)** 8472 D1363, 7997 D1092, **DENALI (08-09)** 7997 D1092, **GMC YUKON XL (16-18), XL 1500 (05-14)** 8472 D1363, 7997 D1092, **RUEDA DELANTERA**

HO211X Ø 47.96mm
h. 52.20mm
HOR211X

BUICK ENCLAVE (10-15) 8410 D1169, **CHEVROLET COLORADO (09-12), EQUINOX (10-18), TRAIL BLAZER (06-07)** 8282 D1169, **TRAVERSE (09-17), GMC ACADIA (07-17)** 8410 D1169, **CANYON (09-12), ENVOY (06-09)** 8282 D1169, **RUEDA DELANTERA**

HO211Z Ø 50.90mm
h. 53.10mm
HOR211Z

CADILLAC ESCALADE (07-16), CHEVROLET AVALANCHE (07-13), CHEYENNE (10-11), SILVERADO 1500 (08-15), SUBURBAN 1500 (07-15), TAHOE (07-15), GMC SIERRA1500 (07-13) YUKON (07-16) 8312 D1194, **RUEDA TRASERA**

HO216 Ø 85.50mm
h. 56.40mm
HOR216

CHEVROLET C35 (87-00) 7081 D149, 7815 D380, **C3500 (94-00), HEAVY DUTY (96-01)** 7815 D380, **MICRO (87-00)** 7081 D149, **RUEDA DELANTERA**

HO216A Ø 85.90mm
h. 56.00mm
HOR216A

CHEVROLET C3500 (91-00), CHEYENNE 3500 (87-97), EXPRESS 3500 (96-02) 7339 D459, **P30 (92-94)** 7081A D149, **GMC SAVANA 2500 (01-02), DODGE CLUB CAB (95-97), RAM 2500 (94-01), RAM 3500 (94-01)** 7339 D459, **RUEDA DELANTERA**

PISTONES PARA CALIPER



CHEVROLET / JAGUAR / GMC / BUICK / PONTIAC

HO216B

Ø 47.91mm
h. 49.00mm
HOR216B



CHEVROLET CHEVY (94-12) 7563 D688, 72X2 D688, 72X1 F038, **MONZA (03)**, **CHEVY PICK UP (99-03)**, **SWING (94-03)**, **CHEVROLET JOY (94-97)**, **JAGUAR XJ8 (98-02)**, **XJR (99-02)**, **XK8 (97-05)** 7563 D688, **RUEDA DELANTERA**

HO216C

Ø 63.50mm
h. 55.00mm
HOR216C



CHEVROLET C10 (88-98), **C15 (93-98)**, **C1500 (91-99)**, **C20 (88-97)**, **SILVERADO (95-96)**, **C1500 SUBURBAN (92-99)**, **C2500 (88-00)**, **GMC YUKON (94-00)** 7259 D369, **RUEDA DELANTERA**

HO216D

Ø 38.00mm
h. 42.00mm
HOR216D



BUICK REGAL (94-01) 7387 D508, **RUEDA TRASERA**

HO216E

Ø 37.98mm
h. 50.00mm
HOR216E



BUICK REGAL (97-04) 7387 D698, **CHEVROLET IMPALA (00-03)** 7574 D699, **TIGRA (99)** 7387 D698, **VENTURE (00-05)** 7574 D699, **PONTIAC AZTEK (01-05)** 7387 D814, **GRAND AM (99-05)**, **GRAND PRIX (97-03)** 7387 D698 **RUEDA TRASERA**

HO216F

Ø 53.87mm
h. 54.70mm
HOR216F



CHEVROLET ASTRO (03-05) 7700 D792, **AVALANCHE 1500 (02-07)** 7707 D834, **2500 (02-06)** 7653 D785, **SILVERADO 1500 (99-04)** 7662 D792, **TAHOE (00-01)** 7707 D834, **GMC SAFARI (03-05)**, **GMC SIERRA 1500 (99-03)** 7662 D792, **RUEDA TRASERA**

HO2503

Ø 60.20mm
h. 53.20mm
HOR2503



CHEVROLET HHR (06-11), **MALIBU (04-12)**, **PONTIAC G5 (08-09)** 8270 D1160, **G6 (05-10)** 7932 D1028, 8270 D1160, **RUEDA DELANTERA**

HO2504

Ø 57.00mm
h. 53.33mm
HOR2504



CHEVROLET SILVERADO 2500 (08-17), **3500 (08-18)**, **EXPRESS 1500 (08-17)**, **GMC EXPRESS VAN (08-17)**, **SIERRA 3500 HD (08-12)** 8523 D1411, **RUEDA TRASERA**

HO2505

Ø 53.88mm
h. 49.00mm
HOR2505



MAZDA 3 (14-18) 8987 D1759, **CHEVROLET AVEO (06-16)**, **OPTRA (04-10)**, **SPARK (13-15)**, **SPARK CLASSIC (16-17)**, **PONTIAC G3 (09-10)** 7779 D1035, **RUEDA DELANTERA**

HO2506

Ø 51.89mm
h. 48.30mm
HOR2506



CHEVROLET BEAT (18-21), **SPARK (11-21)**, **GT (11-18)** 8801 D1590 **RUEDA DELANTERA**

HO2507

Ø 59.84mm
h. 51.50mm
HOR2507



BUICK ENCORE (15-16) 8667 D1467, 84X0 F368, **CHEVROLET CRUZE (10-16)** 8730 D1522, 84X0 F368, 8667 D1467, **SONIC (12-16)**, **TRAX (13-17)**, **VOLT (11-16)** 8730 D1522, 84X0 F368, **RUEDA DELANTERA**

HO2509

Ø 42.43mm
h. 54.00mm
HOR2509



CHEVROLET DMAX 2WD (10-12) 8906 D1677, **RUEDA DELANTERA**

HO2510

Ø 44.30mm
h. 45.00mm
HOR2510



ISUZU DMAX 4WD (10-12) 8906 D1677, **RUEDA DELANTERA**

CHEVROLET / GMC / FORD / CADILLAC / HYUNDAI / KIA / PONTIAC / SUZUKI / BUICK / AM GENERAL / OLDSMOBILE

HO2511 Ø 48.00mm
h. 53.00mm
HOR2511

CHEVROLET COLORADO (21-22)
9600 D2371, GMC CANYON (21-22)
9600 D2371, RUEDA DELANTERA

HO2512 Ø 47.50mm
h. 53.50mm
HOR2512

CHEVROLET SILVERADO 1500 (11-15), SILVERADO 3500 (11-15), GMC SIERRA 3500 HD (11-15) 8523 D1411,
RUEDA DEL Y TRA

HO2513 Ø 60.20mm
h. 53.50mm
HOR2513

CHEVROLET EXPRESS 3500 (11-17), EXPRESS 3500 (15-17) EXPRESS 4500 (14-15), GMC SAVANA 4500 (09-15), SIERRA 2500 HD (11-17), SIERRA 3500 HD (11-17) 8523 D1411, CHEVROLET SILVERADO 2500 (11-17), SUBURBAN 3500 HD (16-19) 8523 D1565,
RUEDA DELANTERA

HO2514 Ø 53.94mm
h. 51.00mm
HOR2514

FORD E450 SUPER DUTY (08-19)
8442 D1330, EXPRESS 3500 (11-17), EXPRESS 4500 (09-17), EXPRESS 4500 (09-17), GMC SAVANA 4500 (09-15), CHEVROLET SILVERADO 2500 (11-15) SILVERADO 3500 (11-15), 8523 D1411,
RUEDA TRASERA

HO2515 Ø 44.92mm
h. 49.20mm
HOR2515

CADILLAC CTS (08-14), STS (08-11), SRX (08-14), (08-14) CHEVROLET CAMARO (10-15) D1337, CAPTIVA SPORT (08-15), EQUINOX (07-08) 8381 D1264, HYUNDAI EQUUS (13-16) D1284, SANTA FE LIMITED (13-16) D1202, KIA SEDONA (02-05) 7781 D903, 8201 D1097, PONTIAC TORRENT (06-08), SATURN VUE (08-10), SUZUKI XL7 (07-09) 8381 D1264,
RUEDA DELANTERA

HO2517 Ø 59.95mm
h. 55.90mm
HOR2517

CHEVROLET CRUZE (16-18) 9072 D1844, MALIBU (17-18) 9072 D1913, VOLT (16-17) 9072 D1844
RUEDA DELANTERA

HO2518 Ø 51.00mm
h. 51.00mm
HOR2518

CHEVROLET AVEO (18-19)
9167 D1942, RUEDA DELANTERA

HO2520 Ø 51.00mm
h. 30.00mm
HOR2519

GMC SIERRA 1500 (19-20),TAHOE (21-22), CHEVROLET SILVERADO 1500 (19-21), YUKON XL (21-22) 9418 D2173, RUEDA DELANTERA

HO2521 Ø 42.70mm
h. 44.60mm
HOR2521

CHEVROLET COLORADO (15-20) GMC CANYON (15-20) 9041 D1806
RUEDA TRASERA

HO2522 Ø 51.00mm
h. 53.30mm
HOR2522

CHEVROLET SILVERADO 1500 (19-20), GMC SIERRA 1500 (19-20), 9419 D2174, RUEDA TRASERA

HO2523 Ø 51.93mm
h. 50.50mm
HOR2523

CHVROLET SPARK NG (16-20) 9254 D2024 RUEDA DELANTERA

HO2524 Ø 45.30mm
h. 34.40mm
HOR2524

GMC CANYON (15-20) 9034 D1802 CHEVROLET COLORADO (14-20) 9034 D1802 RUEDA DELANTERA

PISTONES PARA CALIPER



CHEVROLET / GMC / FORD / CADILLAC / HYUNDAI / KIA / PONTIAC / SUZUKI / BUICK / AM GENERAL / OLDSMOBILE

HO2525 Ø 60.00mm
h. 50.50mm
HOR2525

CHEVROLET CAMARO (16-20)
9114 D1886, **GM TRUCK EQUINOX (18-21)** 9114 D1886, **GM TRUCK TERRAIN (18-21)** 9114 D1886,
RUEDA DELANTERA

HO2527 Ø 54.00mm
h. 53.50mm
HOR2527

CHEVROLET TORNADO VAN (22-23)
757Y F574 **RUEDA DELANTERA**

HO216G Ø 41.80mm
h. 59.00mm
HOR216G

BUICK REGAL (90-99), CHEVROLET LUMINA (90-01), PONTIAC GRAND PRIX (88-95) 7265 D376
RUEDA DELANTERA

HO216H Ø 44.90mm
h. 52.70mm
HOR216H

CHEVROLET ASTRO (03-05), AVALANCHE 1500 (02-06), CADILLAC ESCALADE (02-06), AM GENERAL HUMMER H2 (05-09), GMC SAFARI (03-06), SAVANA 2500 (03-05) 7653 D785, **CHEVROLET SILVERADO 2500 (02-05)** 7652 D784, **SILVERADO 3500 (08-10), SONORA (01-06), SUBURBAN 1500 (00-13), 7653 D785, TRAILBLAZER (03-05)** 7759 D882,
RUEDA DEL Y TRA

HO216I Ø 48.00mm
h. 48.50mm
HOR216I

BUICK ENCLAVE (10-16), CHEVROLET TRAIL BLAZER (02-12), TRAVERSE (09-16), GMC ACADIA (07-15), ENVOY (06-09), OLDSMOBILE BRAVADA (02-04) 7760 D883, **RUEDA TRASERA**

HO216J Ø 63.50mm
h. 43.50mm
HOR216J

CHEVROLET BLAZER (95-99), S10 (95-03) 7480A D202, **GMC SONOMA (94-01)** 7070 D202, **OLDSMOBILE BRAVADA (91-97)** 7759 D882
RUEDA DELANTERA

HO216K Ø 48.00mm
h. 49.00mm
HOR216K

CHEVROLET BLAZER (97-05), S10 (98-04), GMC JIMMY (97-05), SONOMA (98-04), ISUZU HOMBRE (97-00), OLDSMOBILE BRAVADA (97-01) 7596 D729, **RUEDA TRASERA**

HO216L Ø 45.85mm
h. 52.00mm
HOR216L

CHEVROLET BLAZER (98-05), S10 (98-04), GMC JIMMY (97-05), SONOMA (98-04), ISUZU HOMBRE (97-00), OLDSMOBILE BRAVADA (97-01) 7593 D726, **RUEDA DELANTERA**

HO216M Ø 56.90mm
h. 58.00mm
HOR216M

CHEVROLET EXPRESS 1500 (02-10), EXPRESS 2500 (03-08), AM GENERAL HUMMER H2 (02-09), GMC SAVANA 2500 (03-14), SIERRA 2500 HD (10-15), CHEVROLET SILVERADO 2500 (99-15), SILVERADO 3500 (04-15), GMC YUKON XL 2500 (07-13) 7652 D784, **RUEDA DELANTERA**

HO216N Ø 53.90mm
h. 48.50mm
HOR216N

HYUNDAI ELANTRA (92-95), EXCEL (90-94) 7305 D418, **GEO TRACKER 2 PUERTAS (96-01), GEO TRACKER 4 PUERTAS (96-01), 7435 D556**
RUEDA DELANTERA

HO216P Ø 63.38mm
h. 58.50mm
HOR216P

BUICK CENTURY (97-05), CHEVROLET VENTURE (97-01) 7574 D699, **OLDSMOBILE SILHOUETTE (97-01), PONTIAC GRAND PRIX (97-03), MONTANA (99-05)** 7693 D818,
RUEDA DELANTERA

HO216R Ø 59.98mm
h. 59.00mm
HOR216R

CHEVROLET C4500 KODIAK (03-06), C5500 KODIAK (03-06), C6500 KODIAK (03-06), C7500 KODIAK (03-05) 7914 D1010, **FORD F450 SUPER DUTY (09-15), F550 SUPER DUTY (09-14)** 7962 D1066, **RUEDA DEL Y TRA**

* TODOS LOS PISTONES INCLUYEN LIGA Y SILICÓN

*Ø. = DIÁMETRO EXTERIOR
*h. = ALTURA
*CE. = CÓDIGO EQUIVALENTE

PISTONES PARA CALIPER

CHEVROLET / GMC / OLDSMOBILE / ISUZU / AM GENERAL / HYUNDAI / BUICK / PONTIAC / FORD / DAEWOO

HO216S Ø 65.86mm
h. 60.50mm
HOR216S

CHEVROLET C7500 KODIAK (03-05)
7914 D1010, RUEDA DEL Y TRA

HO216T Ø 44.35mm
h. 56.50mm
HOR216T

CHEVROLET AVALANCHE 1500 (02-07), CARGO VAN (03-04), CHEVY VAN (03-06), EXPRESS 1500 (03-14) 7881 D974, 2500 (03-14) 7875 D974, RUEDA TRASERA

HO216U Ø 47.93mm
h. 48.50mm
HOR216U

CHEVROLET MATIZ (11-15), DAEWOO NUBIRA (99-02) 74X7 F139, PONTIAC MATIZ (04-10) 8433 D1321, 74X7 F139, RUEDA DELANTERA

HO216W Ø 50.53mm
h. 63.00mm
HOR216W

CHEVROLET EXPRESS (03-06)
7881 D974, RUEDA DELANTERA

HO216X Ø 38.00mm
h. 45.10mm
HOR216X

CHEVROLET MONTE CARLO (02-06) VENTURE (02-04), OLDSMOBILE SILHOUETTE (01-05) 7387 D814, RUEDA TRASERA

HO216Z Ø 41.15mm
h. 45.30mm
HOR216Z

ISUZU AMIGO (98-00) 7460 D580, 7586 D580, HOMBRE 2WD (97-00), 4WD (98-00) 7586 D580, RODEO (93-04) 7460 D580, 7586 D580, RODEO SPORT (02-03), TROOPER II (92-02) 7586 D580 RUEDA TRASERA

HO217F Ø 69.95mm
h. 54.30mm
HOR217F

CHEVROLET C5500 KODIAK (05-09), C6500 KODIAK (03-09), C7500 KODIAK (00-08), 7636 D1032, RUEDA DEL Y TRA

HO217H Ø 65.86mm
h. 49.43mm
HOR217H

AM GENERAL HUMMER (97-01)
7658 D788, RUEDA DEL Y TRA

HO209 Ø 69.85mm
h. 45.00mm
HOR209

DODGE DART (74-76), MAGNUM (83-88), VOLARE (76-80) 7017 D84, FORD LTD (71-72) 773 D33, PLYMOUTH VALIANT (73-75) 7017 D84, RUEDA DELANTERA

HO212 Ø 78.68mm
h. 45.00mm
HOR212

DODGE D100 (75-85) 7019 D86, 7019 D269, D150 (77-93) 7019 D86, 7019 D123, 7019 D269, D250 (86-93) 7019 D269, D300 (75-80) 7019 D86, 7019 D269, D350 (81-93) 7019 D123, 7019 D86, 7019 D269, RAM 1500 (95-97), RAM MAXIWAGON (95-97), RAMCHARGER (86-96), W150 (85-87), DW250 (86-93) 7179 D269, RUEDA DELANTERA

HO212A Ø 78.66mm
h. 45.00mm
HOR212A

DODGE CORONET (68-70), MONACO (90-92), FORD GALAXIE 500 (70-73), LTD (73-78), A.M. AMERLIN (62-68) 781 D39, VAM GREMLIN (74-76), A.M. PACER (75-76) 781 D92, RUEDA DELANTERA

HO212B Ø 69.80mm
h. 55.90mm
HOR212B

DODGE DAKOTA (95-99) 7616 D746, DURANGO (98-02) 7616 D820, RUEDA DELANTERA

PISTONES PARA CALIPER



ISUZU / CHEVROLET / AM GENERAL / DODGE / PLYMOUTH / FORD / JEEP / CHRYSLER

HO212C

Ø 47.80mm
h. 47.35mm
HOR212C



JEEP GRAND CHEROKEE (99-04)
7661 D791, RUEDA TRASERA

HO212D

Ø 65.94mm
h. 51.00mm
HOR212D



JEEP GRAND CHEROKEE (93-01)
7507 D477, LIBERTY (02-07) 7732
D85, RUEDA DELANTERA

HO212F

Ø 63.95mm
h. 53.15mm
HOR212F



**CHRYSLER GRAND VOYAGER (01-06),
TOWN & COUNTRY (02-07), VOYAGER
(01-06), DODGE CARAVAN (01-07),
GRAND CARAVAN (01-05) 7732 D856,
RUEDA DELANTERA**

HO212G

Ø 65.94mm
h. 52.00mm
HOR212G



**CHRYSLER TOWN & COUNTRY (01-07),
VOYAGER (01-08), DODGE CARAVAN
(01-07), GRAND CARAVAN (01-07) 7733
D857, RUEDA DEL Y TRA**

HO212I

Ø 56.00mm
h. 55.00mm
HOR212I



**DODGE RAM 2500 (01-02), 3500 (01-02),
4000 (01-05) 7694 D859, FORD F250
(95-00), F350 (95-07) 7535 D655, F450
(03-07) 7677 D655, RUEDA DELANTERA**

HO212J

Ø 41.90mm
h. 50.00mm
HOR212J



**CHRYSLER GRAND VOYAGER (01-06),
TOWN & COUNTRY (01-07), VOYAGER
(01-08), DODGE CARAVAN (01-07),
GRAND CARAVAN (01-07) 7734 D858,
RUEDA TRASERA**

HO212K

Ø 65.85mm
h. 52.00mm
HOR212K



**DODGE DAKOTA (95-97) 7410 D529
DAKOTA (93-98) 7410 D593
RUEDA DELANTERA**

HO212M

Ø 59.87mm
h. 55.40mm
HOR212M



**CHRYSLER CIRRUS SEDAN (01-06),
SEBRING (01-06), CONCORDE (98-
03), STRATUS (01-06)
7744 D869, RUEDA DELANTERA**

HO212N

Ø 56.00mm
h. 55.00mm
HOR212N



**DODGE RAM 2500 (03-08), RAM 3500
(05-08), RAM MEGA CAB (07-08)
7864 D965, RUEDA DELANTERA**

HO212P

Ø 47.85mm
h. 52.37mm
HOR212P



**JEEP COMMANDER (06-10),
GRAND CHEROKEE (05-10), 7945
D1087, 7985 D1080, 8297 D1181,
RUEDA DELANTERA**

HO212R

Ø 47.83mm
h. 47.25mm
HOR212R



**JEEP LIBERTY (02-07),
WRANGLER (07-15) 7863 D981,
RUEDA TRASERA**

HO212S

Ø 47.85mm
h. 49.67mm
HOR212S



**CHRYSLER PACIFICA (04-08) 7898
D997, LINCOLN AVIATOR (03-05) 7852
D953, RUEDA DELANTERA**

*Ø. = DIÁMETRO EXTERIOR

*h. = ALTURA

*CE. = CÓDIGO EQUIVALENTE

* TODOS LOS PISTONES INCLUYEN LIGA Y SILICÓN

FRENOS HO 2024-2025

33

CHRYSLER / DODGE / JEEP / MITSUBISHI / VOLKSWAGEN / LINCOLN

HO212T Ø 56.92mm
h. 48.00mm
HOR212T

CHRYSLER SEBRING (01-05), DODGE AVENGER (09-12), CALIBER (07-12), JEEP COMPASS (07-14), PATRIOT (07-14), MITSUBISHI ASX (14-15), ECLIPSE (03-09), GALANT (03-09), LANCER (05-16), OUTLANDER (04-19) 7741 D866, RUEDA DELANTERA

HO212U Ø 34.75mm
h. 45.00mm
HOR212U

CHRYSLER 200 (12-14), SEBRING (07-10), DODGE AVENGER (08-14), CALIBER (07-12), JEEP COMPASS (07-16), PATRIOT (07-16), MITSUBISHI OUTLANDER (05-06) 7940 D1037, RUEDA TRASERA

HO212W Ø 53.86mm
h. 47.25mm
HOR212W

DODGE ATTITUDE (06-11), HYUNDAI ACCENT (06-11), KIA RIO (06-11) 8266 D1156, RUEDA DELANTERA

HO212X Ø 65.86mm
h. 53.57mm
HOR212X

CHRYSLER TOWN & COUNTRY (08-16) 8389 D1327, DODGE NITRO (07-12), JEEP LIBERTY (08-12) 8389 D1273, RENEGADE (15-17) 8389 D1327, WRANGLER (07-15), VOLKSWAGEN ROUTAN (09-11) 8389 D1273, RUEDA DELANTERA

HO212Z Ø 47.86mm
h. 50.57mm
HOR212Z

DODGE DURANGO (11-18) 7660 D942, 7660 D1498, JEEP GRAND CHEROKEE (11-18) 7660 D790, RUEDA TRASERA

HO213 Ø 53.94mm
h. 49.90mm
HOR213

DODGE DART (82-82) 7134 D220 CHRYSLER SHADOW (89-94), DODGE SPIRIT (94-95) 7134 D220, 7403 D521 RUEDA DELANTERA

HO213A Ø 33.92mm
h. 49.00mm
HOR213A

CHRYSLER LEBARON (77-95), PHANTOM (87-92), SHADOW (89-94) 7303 D415, RUEDA TRASERA

HO213B Ø 59.90mm
h. 49.00mm
HOR213B

CHRYSLER GRAND VOYAGER (91-94), LEBARON (77-95), PHANTOM (87-92), INTREPID (93-04) 7623 D730, DODGE SPIRIT (90-95), PLYMOUTH VOYAGER (91-94) 7404A D522, RUEDA DELANTERA

HO213C Ø 35.93mm
h. 48.50mm
HOR213C

CHRYSLER CIRRUS (96-06) 7438 D641, CONCORDE (93-94), LEBARON (77-95), NEW YORKER (91-94) 7438A D559, SEBRING (96-99) 7438B D641, SHADOW (89-94), INTREPID (93-02) 7438A D559, NEON (95-05), 7438 D759, 7438B D641, PT CRUISER (03-10) 7438B D641, DODGE SPIRIT (91-95), STRATUS (95-06) 7438B D641, 7438 D759, RUEDA TRASERA

HO213D Ø 53.86mm
h. 49.40mm
HOR213D

CHRYSLER ASPEN (07-09) 7869 D967, DODGE DURANGO (04-09) 7869 D967, 7868 D966, NEON (95-97), R14 (95-97) 7518A D642, RAM1500 (03-16) 7869 D967, RUEDA DEL Y TRA

HO213E Ø 53.94mm
h. 48.00mm
HOR213E

CHRYSLER CIRRUS (95-00) DODGE STRATUS (95-00) 7530A D650, RUEDA DELANTERA

HO3100 Ø 50.90mm
h. 57.30mm
HOR3100

DODGE RAM 2500, 3500 (09-10), 8508 D1400, RUEDA TRASERA

*Ø. = DIÁMETRO EXTERIOR
*h. = ALTURA
*CE.= CÓDIGO EQUIVALENTE

* TODOS LOS PISTONES INCLUYEN LIGA Y SILICÓN

PISTONES PARA CALIPER



CHRYSLER / DODGE / MERCEDES BENZ / JEEP / VOLKSWAGEN

HO3101

Ø 44.85mm
h. 59.20mm
HOR3101

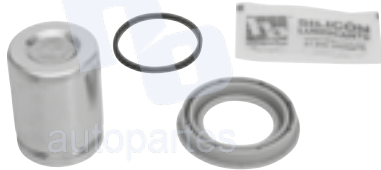

DODGE RAM 2500, 3500 (11-18), 8508 D1400, RUEDA TRASERA

HO3102

Ø 47.90mm
h. 55.60mm
HOR3102



DODGE DURANGO (11-19), JEEP GRAND CHEROKEE (11-19) 8655 D1455, MERCEDES BENZ GL350 (10-16) 8856 D1904, ML350 (06-12) 8856 D1629, RUEDA DELANTERA

HO3103

Ø 50.90mm
h. 53.40mm
HOR3103



CHRYSLER PACIFICA (17-20), TOWN & COUNTRY (12-16), DODGE GRAND CARAVAN (12-20), JOURNEY (12-19), RAM CARGO VAN (13-15) JEEP WRANGLER (18-21), VOLKSWAGEN ROUTAN (12-14) 8800 D1589, RUEDA DELANTERA

HO3104

Ø 60.20mm
h. 49.30mm
HOR3104



DODGE DART (13-16) 8867 D1640, 8982 D1640 RUEDA DELANTERA

HO3105

Ø 65.86mm
h. 60.50mm
HOR3105



DODGE RAM 4000 (08-20) 8446 D1335 RUEDA DELANTERA

HO3106

Ø 60.10mm
h. 53.50mm
HOR3106



CHRYSLER 200 HEAVY DUTY BRAKES 3.6L (15-16) 9003 D1640, RUEDA DELANTERA

HO3107

Ø 60.12mm
h. 49.30mm
HOR3107



CHRYSLER 200 STANDARD BRAKES 2.4L (15-16), DODGE DART (16) 9003 D1640, RUEDA DELANTERA

HO3108

Ø 54.00mm
h. 51.00mm
HOR3108



DODGE PROMASTER RAPID (15-18), RAM 700 (15-18), VISION (15-18), FIAT STRADA (07-14) 7W04Z F498, RUEDA DELANTERA

HO3109

Ø 50.68mm
h. 44.70mm
HOR3109



DODGE ATTITUDE (15-18), MITSUBISHI MIRAGE G4 (17-20) 8956 D1731, RUEDA DELANTERA

HO3110

Ø 60.20mm
h. 56.00mm
HOR3110



DODGE RAM 2500 (19-20), RAM 3500 (19-20) 9462 D2223, RUEDA DELANTERA

HO3111

Ø 51.97mm
h. 58.00mm
HOR3111



DODGE RAM PROMASTER CITY 1500 (18-20), 1500 (14-17), 2500 (14-17), 3500 (14-17), FIAT DUCATO (14-17), 9070 D1842, 9071 D1540, MERCEDES BENZ SPRINTER 1500 (19-21), 2500 (19-21), 3500 (19-21) 8748, D1540 RUEDA DELANTERA

HO3112

Ø 45.94mm
h. 58.00mm
HOR3112



DODGE RAM 1500 (14-17), 2500 (14-17), 3500 (14-17), FIAT DUCATO (14-17), 9070 D1842, 9071 D1540 RUEDA DELANTERA

*Ø. = DIÁMETRO EXTERIOR

*h. = ALTURA

*CE. = CÓDIGO EQUIVALENTE

* TODOS LOS PISTONES INCLUYEN LIGA Y SILICÓN

FRENOS HO 2024-2025

PISTONES PARA CALIPER

CHRYSLER / DODGE / FIAT / MITSUBISHI / JEEP

HO3113

Ø 48.00mm
h. 51.00mm
HOR3113



JEEP WRANGLER (18-20)
8332 D2186, RUEDA TRASERA

HO3114

Ø 48.00mm
h. 51.00mm
HOR3114



JEEP CHEROKEE (14-15)
8932 D1709, RUEDA DELANTERA

HO3115

Ø 57.00mm
h. 53.00mm
HOR3115



RAM TRUCK 1500 SERIES 1/2 TON
RAM PICKUP (19-22) 9412 D2169
JEEP GRAND WAGONEER (22) 9412
D2169 **JEEP WAGONEER (22)** 9412
D2169 **RUEDA TRASERA**

HO213F

Ø 57.12mm
h. 54.00mm
HOR213F



CHRYSLER PT CRUISER (01-10)
DODGE NEON (04-05), 7716 D841,
RUEDA DELANTERA

HO213G

Ø 60.23mm
h. 49.00mm
HOR213G



CHRYSLER CIRRUS COUPE (00-01)
SEBRING COUPE (95-05), **DODGE**
STRATUS COUPE (00-02), **FAW GF 1500**
(15-16), **MITSUBISHI GALANT (90-01)**,
ECLIPSE (90-01), **MIRAGE (90-01)**
7365 D484, **RUEDA DELANTERA**

HO213H

Ø 53.90mm
h. 46.00mm
HOR213H



CHRYSLER CIRRUS COUPE (00-01)
SEBRING COUPE (95-00), **DODGE**
STRATUS B COUPE (00-02)
7272 D383, **RUEDA TRASERA**

HO213I

Ø 50.96mm
h. 52.38mm
HOR213I



DODGE DAKOTA (03-04) 7861 D962
RUEDA DELANTERA

HO213J

Ø 50.95mm
h. 56.38mm
HOR213J



DODGE DAKOTA (03-04) 7862 D963
RUEDA TRASERA

HO213K

Ø 41.90mm
h. 52.46mm
HOR213K



CHRYSLER PACIFICA (04-08)
7899 D998, **RUEDA TRASERA**

HO213L

Ø 35.91mm
h. 56.60mm
HOR213L



DODGE RAM 1500, 2500, 3500 (04-08)
7865 D1077, **RUEDA TRASERA**

HO213M

Ø 60.40mm
h. 55.13mm
HOR213M



CHRYSLER 300 (05-18),
DODGE CHARGER (06-10)
7962 D1056, **RUEDA DELANTERA**

HO213N

Ø 41.91mm
h. 53.07mm
HOR213N



CHRYSLER 300 (05-18) 7963 D1057,
MAZDA BT50 (13-19) 7963 D1676
DODGE CHARGER (06-22), **MAGNUM**
(05-08) 7963 D1057, **FORD RANGER (13-18)**
7963 D1676, **RUEDA TRASERA**

PISTONES PARA CALIPER



CHRYSLER / DODGE / MERCEDES BENZ / JEEP / VOLKSWAGEN / HYUNDAI

HO213P

Ø 57.00mm
h. 32.05mm
HOR213P



DODGE RAM 1500 (05-06) 8291 D1085, 7992 D1085, **RAM 1500 SRT 10 (05-06)** 7992 D1085, **RUEDA DELANTERA**

HO213R

Ø 53.88mm
h. 53.48mm
HOR213R



CHRYSLER ASPEN (07-09), DODGE DAKOTA (05-11), DURANGO (07-09), RAM 1500 (06-16) 7991 D1084, **RUEDA DELANTERA**

HO213S

Ø 44.79mm
h. 57.70mm
HOR213S



DODGE RAM 1500 (03-08), RAM 2500 (03-08), RAM 3500 (03-08) 7865 D1077, **RUEDA TRASERA**

HO213T

Ø 47.94mm
h. 49.53mm
HOR213T



DODGE NITRO (07-12), JEEP LIBERTY (08-12), SERIES CJ (07), WRANGLER (07-16) 8390 D1274, **RUEDA TRASERA**

HO213U

Ø 43.79mm
h. 32.00mm
HOR213U



CHRYSLER 300 (05-14) 8259 D1149, 7965 D1058, **300C (06-08), DODGE CHALLENGER (09-16), SRT8 (06-20), MAGNUM SRT8 (06-08), JEEP GRAND CHEROKEE SRT8 (06-10), MERCEDES BENZ S550 (07-09)** 8259 D1149, **RUEDA DELANTERA**

HO213W

Ø 45.95mm
h. 47.00mm
HOR213W



DODGE H100 (05-09) 8729 D1520, 7X35 F278 **RUEDA DELANTERA**

HO213Z

Ø 47.53mm
h. 59.00mm
HOR213Z



JEEP GRAND CHEROKEE (99-04) 7846 D945, **RUEDA DELANTERA**

HO208

Ø 55.40mm
h. 48.00mm
HOR208



FORD F250 (89-94) 7330 D450, **F350 (68-91)** 771 D20, 7330 D450, **F350 (85-91), ECONOLINE (85-91)** 7054 D120, **RUEDA DELANTERA**

HO208A

Ø 56.00mm
h. 55.50mm
HOR208A



FORD E250 (99-02), E-250 ECONOLINE (99-02), F200 (86-91), F250 (95-96), F350 (95-98) 7535 D655 **RUEDA DELANTERA**

HO208B

Ø 56.00mm
h. 62.00mm
HOR208B



FORD ECONOLINE E250 (92-05) 7436 D557, **E350 (92-05)** 7535 D655, **RUEDA DELANTERA**

HO208C

Ø 53.85mm
h. 58.50mm
HOR208C



FORD EXCURSION (00-05) 7625 D824 **F250 (98-04), F350 (98-00)** 7625 D756, 7625 D824, **F350 SUPER DUTY (99-08)** 7625 D756, 7625 D824, **F350 SUPER DUTY (99-00)** 7625 D756, **RUEDA DEL Y TRA**

HO208D

Ø 53.90mm
h. 55.00mm
HOR208D



FORD FOCUS (00-07) 7690 D816, 7947 D1044, **FOCUS ZX3 WAGON (00-03)** 7947 D816, **RUEDA DELANTERA**

*Ø. = DIÁMETRO EXTERIOR

*h. = ALTURA

*CE. = CÓDIGO EQUIVALENTE

* TODOS LOS PISTONES INCLUYEN LIGA Y SILICÓN

FRENOS HO 2024-2025

37

PISTONES PARA CALIPER

JEEP / FORD / LINCOLN

HO208E Ø 45.85mm
h. 51.00mm
HOR208E

FORD EXPLORER (02-10) 7706 D833, RANGER (95-11), MERCURY MOUNTAINEER (97-01) 7532 D652 RUEDA DELANTERA

HO208F Ø 50.90mm
h. 50.00mm
HOR208F

FORD EXPEDITION (97-02), F150 (96-06), F250 (98-99), LINCOLN NAVIGATOR (98-02) MERCURY GRAND MARQUIS (02-11) 7584 D711, RUEDA TRASERA

HO208G Ø 50.99mm
h. 56.45mm
HOR208G

FORD F150 (04-09) 7915 D1011, RUEDA DELANTERA

HO208H Ø 50.98mm
h. 52.30mm
HOR208H

FORD F150 (05-12) LOBO (05-12), LINCOLN MARK LT (06-08) 7916 D1012, RUEDA TRASERA

HO208I Ø 48.00mm
h. 53.40mm
HOR208I

FORD F250 (05-07), F350 (05-08) 7973 D1068 RUEDA TRASERA

HO208J Ø 50.85mm
h. 53.47mm
HOR208J

FORD FREESTAR (04-07) 7997 D1022 RUEDA DELANTERA

HO208K Ø 44.97mm
h. 52.80mm
HOR208K

FORD FIVE HUNDRED (05-07) TAURUS (08-09) 7975 D1070 RUEDA DELANTERA

HO208L Ø 50.62mm
h. 50.93mm
HOR208L

FORD EXPLORER (06-09) EXPLORER SPORT TRAC (07-10) 8268 D1158, RUEDA DELANTERA

HO208M Ø 56.90mm
h. 50.56mm
HOR208M

FORD EXPEDITION (03-07) LINCOLN NAVIGATOR (07-09) 8394 D1278, RUEDA DELANTERA

HO208N Ø 44.83mm
h. 47.46mm
HOR208N

FORD E250 (02-07), E350 ECONOLINE (07-08) 7673 D802, RUEDA TRASERA

HO208P Ø 59.81mm
h. 58.59mm
HOR208P

FORD F450 SUPER DUTY (03-07), F53 Motorhome Chassis (88-97) 7299 D411 RUEDA TRASERA

HO208R Ø 51.83mm
h. 56.00mm
HOR208R

FORD EXPEDITION (03-06) 7837 D934, LINCOLN NAVIGATOR (03-06) 7837 D934, 7838 D935, RUEDA DELANTERA

PISTONES PARA CALIPER



FORD / LINCOLN

HO208S

Ø 53.90mm
h. 56.30mm
HOR208S



FORD F150 (04-09), LINCOLN MARK LT (06-08) 7915 D1083 RUEDA DELANTERA

HO208T

Ø 59.81mm
h. 58.50mm
HOR208T



FORD F250 (05-09), F350 (05-09) 7974 D1333, RUEDA DELANTERA

HO208U

Ø 53.88mm
h. 53.48mm
HOR208U



FORD F350 (05-09) 7973 D1334 RUEDA TRASERA

HO210

Ø 72.98mm
h. 48.30mm
HOR210



FORD BRONCO (94-96), FORD F150 (94-96) 7503 D632, RUEDA DELANTERA

HO210A

Ø 73.00mm
h. 45.00mm
HOR210A



FORD CROWN VICTORIA (79-93) 7082A D150, LTD CROWN VICTORIA (86-91) 7013A D50, 7082A D150, 7082C D199, F100 (77-83), F150 (73-87) 7013A D50, FORD LTD (79-81) 7082A D150, 7013A D50, 7082C D199, MERCURY GRAND MARQUIS (81-93) 7082A D150, 7082C D199, 7013A D50, RUEDA DELANTERA

HO210B

Ø 47.93mm
h. 49.70mm
HOR210B



FORD LTD CROWN VICTORIA (87-91) 7565 D690, GRAND MARQUIS (92-02), LINCOLN TOWN CAR (91-01) 7610 D674, MERCURY GRAND MARQUIS (92-02) 7545 D690, MOUNTAINEER (97-01) 7545 D667, RUEDA TRASERA

HO210C

Ø 47.90mm
h. 49.00mm
HOR210C



FORD LTD CROWN VICTORIA (87-91) 7834 D931, F150 (96-04), LOBO (97-04) 7558 D679, LINCOLN TOWN CAR (03-04) 7834 D931, RUEDA DELANTERA

HO210D

Ø 53.87mm
h. 44.00mm
HOR210D

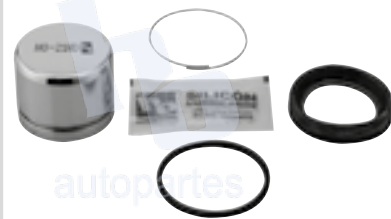

FORD ESCORT (91-02) 7219 D466, 7353 D473, 7630 D762, RUEDA DELANTERA

HO210F

Ø 50.90mm
h. 48.00mm
HOR210F



FORD EXPEDITION (97-02), EXPLORER (95-11) 7532 D652, F150 (01-04), F250 (97-99), LOBO (00-04) 7576 D702, RUEDA DELANTERA

HO210G

Ø 44.34mm
h. 56.50mm
HOR210G



FORD EXCURSION (00-05) FORD F250 (98-02), F350 SUPER DUTY (99-02) 7626 D757, RUEDA TRASERA

HO210H

Ø 47.80mm
h. 50.00mm
HOR210H



FORD WINDSTAR (99-03) 7674 D803, RUEDA DELANTERA

HO210I

Ø 59.93mm
h. 55.50mm
HOR210I



FORD CONTOUR (95-00) 7630 D762, MERCURY MYSTIQUE (98-00) 7528 D745, RUEDA DELANTERA

FORD / DODGE / LINCOLN

HO210J Ø 53.93mm
h. 51.00mm
HOR210J

FORD COURIER (01-12) 8289 D1175, 75X6 F093, **ECOSPORT (04-07)** 8289 D1175, **FIESTA (98-10)** 75X6 F093, 8289 D1175, **IKON (04-07), KA (01-08)** 8289 D1175, 7529 D649
RUEDA DELANTERA

HO210K Ø 59.89mm
h. 58.50mm
HOR210K

DODGE RAM 2500 (14-15), RAM 3500 (14-15) 8507 D1399, **FORD F450 (99-04), F550 SUPER DUTY (99-04)** 7644 D777, **RUEDA DELANTERA**

HO210L Ø 65.98mm
h. 46.00mm
HOR210L

FORD AEROSTAR (86-97) 7224 D326, 7488 D607, 7125 D387, **BRONCO (86-87)** 7224 D326, **EXPLORER (91-99)** 7125 D387, **RANGER (86-94)** 7224 D326, 7125 D387, **RUEDA DELANTERA**

HO210M Ø 72.90mm
h. 75.00mm
HOR210M

FORD F700 (81-86), F800 (87-89), FT900 (85-86), LN7000 (86-90), LN800 (84-85), LT800 (80-84) 7809 D236,
RUEDA DELANTERA

HO210N Ø 56.95mm
h. 54.00mm
HOR210N

FORD MONDEO (02-05) 7789 D910,
RUEDA DELANTERA

HO210P Ø 59.94mm
h. 56.50mm
HOR210P

FORD ESCAPE (01-06), MERCURY MARINER (06-07) 7719 D843, **RUEDA DELANTERA**

HO210R Ø 47.87mm
h. 47.25mm
HOR210R

FORD EXPLORER (08-10) 8214 D1109, **EXPLORER SPORT (02-05)** 7907 D881, **EXPLORER SPORT TRAC (06-10)** 8214 D1109, 7907 D881, **MERCURY MOUNTAINEER (08-10)** 8214 D1109,
RUEDA TRASERA

HO210S Ø 53.90mm
h. 52.00mm
HOR210S

FORD ECONOLINE E150 (99-02), E250 (04-07) 7948 D1045,
RUEDA DELANTERA

HO210T Ø 53.88mm
h. 52.14mm
HOR210T

DODGE RAM 1500 (00-01) 7949 D842, **FORD ECONOLINE E150 (99-07)** 7949 D1046, **RUEDA DEL Y TRA**

HO210W Ø 44.80mm
h. 47.43mm
HOR210W

FORD ECONOLINE E150 (99-02) 7949 D1046, **RUEDA DELANTERA**

HO210X Ø 43.76mm
h. 47.10mm
HOR210X

FORD WINDSTAR (99-03) 7674 D803,
RUEDA TRASERA

HO210Z Ø 59.81mm
h. 53.36mm
HOR210Z

FORD E150 (08-14), E250 (08-14), E350 SUPER DUTY (08-19), F450 SUPER DUTY (08-19), F250 (13-21), F350 (14-16), F450 SUPER DUTY (14-16) 8909 D1680, **RUEDA DELANTERA**

PISTONES PARA CALIPER



FORD / DODGE / CHRYSLER / VAM / IHC / LINCOLN

HO215

Ø 65.85mm
h. 46.00mm
HOR215



VAM AMERICAN (73-80) 7027A D91, CHRYSLER CORDOBA (80-82), LEBARON (77-95) 7017A D84, VAM LERMA (81-82), FORD MAVERICK (70-77), AMC PACER (77-79), VAM RALLY (81-84) 7027A D91, CHRYSLER VALIANT (76-83), 7017 D84, FORD WINDSTAR (95-98) 7536 D656, RUEDA DELANTERA

HO217

Ø 59.90mm
h. 45.50mm
HOR217



FORD THUNDERBIRD (89-92), MERCURY COUGAR (89-92) 7304A D417, RUEDA DELANTERA

HO217A

Ø 59.90mm
h. 49.50mm
HOR217A



FORD GHIA (91-93), TOPAZ (84-94) 7106 D257, RUEDA DELANTERA

HO217B

Ø 65.85mm
h. 46.00mm
HOR217B



FORD MUSTANG (94-98), TAURUS (93-97), THUNDERBIRD (93-96), MERCURY COUGAR (93-97) 7478 D600, SABLE (94-01), 7479 D601, RUEDA DELANTERA

HO217C

Ø 73.00mm
h. 46.00mm
HOR217C



LINCOLN TOWN CAR (91-94) 7378B D499, MERCURY GRAND MARQUIS (79-94) 7082A D150, 7378B D499, RUEDA DELANTERA

HO217D

Ø 65.94mm
h. 58.00mm
HOR217D



IHC NAVISTAR INTERNATIONAL 6000 (98-00), 8000 (98-00) 7654 D786, RUEDA DELANTERA

HO217E

Ø 60.23mm
h. 45.00mm
HOR217E



FORD MUSTANG (70-72) 776 D237, 776 D34, RUEDA DELANTERA

HO217I

Ø 47.86mm
h. 47.25mm
HOR217I



FORD EXPLORER (01-05), SPORT TRAC (03-05), MERCURY MOUNTAINEER (03-05) 7545 D667, RUEDA TRASERA

HO217J

Ø 47.93mm
h. 55.50mm
HOR217J



FORD FIESTA (00-01) 769X F174, 8660 D1460, RUEDA DELANTERA

HO217K

Ø 47.50mm
h. 46.00mm
HOR217K



FORD E150 (08-14), E250 (08-14), E350 SUPER DUTY (08-19) 8441 D1329, RUEDA TRASERA

HO217L

Ø 47.46mm
h. 51.00mm
HOR217L



FORD EXPLORER (11-17), FLEX (09-11) 8715 D1508, RUEDA DELANTERA

HO217M

Ø 53.88mm
h. 53.48mm
HOR217M



DODGE RAM 1500 (14-18) 7991 D1084, FORD EXPEDITION (10-19) F150 (10-20), LINCOLN NAVIGATOR (12-21) 9322 D2087, 8528 D1414, RUEDA DEL Y TRA

FORD / DODGE / LINCOLN / MAZDA

HO217N Ø 56.85mm
h. 55.45mm
HOR217N

FORD ESCAPE (07-17), FOCUS (12-17), MAZDA 3 (05-17), 5 (07-17) 7947 D1563, RUEDA DELANTERA

HO217S Ø 53.88mm
h. 53.48mm
HOR217S

FORD F250 (13-19), F350 SUPER DUTY (07-12) F450 (13-15) 8918 D1691, RUEDA TRASERA

HO217T Ø 65.98mm
h. 56.00mm
HOR217T

FORD ESCAPE (05-06), MAZDA TRIBUTE (05-11), MERCURY MARINER (05-11) 7950 D1047, RUEDA DELANTERA

HO217U Ø 59.75mm
h. 59.00mm
HOR217U

FORD F250 SUPER DUTY (11-13), F350 (11-13) 7974 D1333, RUEDA DELANTERA

HO217W Ø 44.97mm
h. 52.80mm
HOR217W

FORD MUSTANG (99-05) 7675 D804, RUEDA DELANTERA

HO217Z Ø 54.00mm
h. 50.00mm
HOR217Z

SUZUKI BALENO (21-22), SWIFT (20-21) 8738 D1454, FORD FIESTA (11-19) 8653 D1454, FIGO (16-20) 8653 D1454, 8X53 F520, RUEDA DELANTERA

HO3200 Ø 45.29mm
h. 53.00mm
HOR3200

FORD EDGE (07-14) 8377 D1258, LINCOLN MKX (07-15) 8384 D1258, MAZDA CX5 (19-21), CX7 (07-12), CX9 (07-21) 8377 D1258, RUEDA DELANTERA

HO3201 Ø 60.00mm
h. 47.00mm
HOR3201

MAZDA CX5 (13-17) 8836 D1623, RUEDA DELANTERA

HO3202 Ø 38.00mm
h. 47.00mm
HOR3202

MAZDA CX5 (13-17) 8837 D1624, RUEDA TRASERA

HO3203 Ø 65.90mm
h. 58.60mm
HOR3203

FORD F450 SUPER DUTY (17-19), FORD F550 SUPER DUTY (17-19) 9249 D2018, RUEDA DELANTERA

HO3204 Ø 53.90mm
h. 52.00mm
HOR3204

FORD F150, FORD EXPEDITION (18-21), LINCOLN NAVIGATOR (18-19) 9018 D1790, RUEDA TRASERA.

HO3205 Ø 53.86mm
h. 49.50mm
HOR3205

MAZDA CX3 (16-22), MAZDA 3 (16-18) 8952 D1728 RUEDA DELANTERA

PISTONES PARA CALIPER



FORD / LINCOLN / MAZDA / HYUNDAI / NISSAN / DATSUN / SUZUKI

HO3206

Ø 45.00mm
h. 48.00mm
HOR3206



FORD TRUCK F-250 SUPER DUTY (16-22) 8918 D1691, F-350 SUPER DUTY (13-22) 8918 D1691 RUEDA TRASERA

HO3207

Ø 30.00mm
h. 45.50mm
HOR3207



FORD ESCORT (91-96) 7338 D458, MAZDA 323 (89-94) 7338 D458, MAZDA PROTEGE (95-98) 7338 D458, MAZDA 626 (92-99) 7464 D584, MAZDA MX6 (93-97) 7464 D584, RUEDA TRASERA

HO207

Ø 50.69mm
h. 39.40mm
HOR207



DATSUN PICK UP (70-84), DATSUN SEDAN (70-83), NISSAN J15 (70-80) 780 D37, RUEDA DELANTERA

HO207A

Ø 60.48mm
h. 48.80mm
HOR207A



NISSAN C120 (87-94), CARAVAN (85-98), 720 (80-86), FIERA (85-98), HOMMY (85-98), ICHIVAN (88-94), PICK UP (85-92), 7170 D265, RUEDA DELANTERA

HO3300

Ø 51.00mm
h. 45.00mm
HOR3300



HYUNDAI GRAND i10 (15-17) 9159 D1935, RUEDA DELANTERA

HO207C

Ø 53.87mm
h. 26.70mm
HOR207C



NISSAN PICK UP (77-82) 7046 D113, 795 D161, 795 D57 RUEDA DELANTERA

HO207CA

Ø 53.91mm
h. 44.50mm
HOR207CA



NISSAN PICK UP USA ALTO (77-82) 7046 D113, 795 D161 RUEDA DELANTERA

HO207B

Ø 48.00mm
h. 48.60mm
HOR207B



NISSAN B11 (82-85), SENTRA (86-94), SENTRA GA 16 (92-00), SUNNY (82-85) 7155 D275, TSUBAME (93-00) 7389 D510, TSURU (84-91) 7155 D275, TSURU (92-17) 7389 D510, VANNETH (82-85), SUZUKI SIDEKICK 2 PUERTAS (93-98) 7155 D275, RUEDA DELANTERA

HO207CB

Ø 53.91mm
h. 37.70mm
HOR207CB



DATSUN PICK UP (77-82) 7046 D113, 795 D161 RUEDA DELANTERA

HO207D

Ø 42.77mm
h. 48.00mm
HOR207D



NISSAN D21 4X2 (86-94), FRONTIER 2WD (98-03), PATHFINDER (87-94), PICK UP (95-10), URVAN (00-01) 7228 D333, SUBARU FORESTER (03-15), IMPREZA (02-15), LEGACY (06-14) 7880 D929, RUEDA DELANTERA

HO207E

Ø 57.12mm
h. 51.00mm
HOR207E



ACURA INTEGRA (90-93) 7235 D409, 7445 D409, INFINITI G20 (91-02) 7318 D430, 7342 D485, I30 (96-01) 7318 D430, 7318 D653, I35 (02-04) 7318 D653, NISSAN 350Z (03-05) 7318 D815, ALTIMA (98-13) 7318 D430, 7318 D653, 7318 D815, 7783 D815, CUBE (09-14) 7783 D815, JUKE (11-15) 7318 D815, MAXIMA (90-03) 7318 D430, 7318 D653, 7783 D815, SENTRA (01-13) 7318 D653, 7318 D430, XE/GXE 1.8L (11-15) 7342 D485, RUEDA DELANTERA

HO207F

Ø 47.90mm
h. 53.20mm
HOR207F



LIFAN UNIVERSAL, NISSAN APRIO (08-10), PLATINA (02-07) 71X4 F051, RENAULT CLIO (02-10) 71X4 F051, 8256 D1146, LOGAN (15-19), MAGANE (01-10), SANDERO (10-11) 71X4 F051, STEPWAY (10-12) 71X4 F051, 8256 D1146, TWINGO (10-11) 71X4 F051, RUEDA DELANTERA

PISTONES PARA CALIPER

NISSAN / SUBARU / ACURA / LIFAN / RENAULT / SUZUKI

HO207G

Ø 44.33mm
h. 52.50mm
HOR207G



NISSAN PATHFINDER (96-00)
XTRAIL (03-06) 7566 D691
RUEDA DELANTERA

HO207H

Ø 48.00mm
h. 45.00mm
HOR207H



NISSAN SENTRA (91-99), SR 20
(91-99), TSURU GSR 2L (93-96)
7388 D509, RUEDA DELANTERA

HO207I

Ø 44.27mm
h. 52.00mm
HOR207I



NISSAN PATHFINDER (88-01) 7910
D691, XTRAIL (03-09) 7566 D691,
RUEDA DELANTERA

HO207J

Ø 34.80mm
h. 45.00mm
HOR207J



NISSAN ALTIMA (02-10), MAXIMA
(03-10), QUEST (04-10), XTRAIL (08-10)
SUZUKI NOMADE (03-10), VITARA (03-04)
7784 D905 RUEDA TRASERA

HO207K

Ø 63.40mm
h. 50.50mm
HOR207K



NISSAN ALTIMA (06-07), MAXIMA
(06-07), MURANO (03-09) 7870 D969,
RUEDA DELANTERA

HO207L

Ø 42.73mm
h. 45.00mm
HOR207L



NISSAN MURANO (03-07) 7784 D905
RUEDA TRASERA

HO207M

Ø 57.10mm
h. 49.90mm
HOR207M



NISSAN ALMERA (01-05)
772X F191, 8257 D1147
RUEDA DELANTERA

HO207N

Ø 50.98mm
h. 52.30mm
HOR207N



NISSAN ARMADA (05-06) 7918 D1015,
TITAN (04-07) 7918 D1063,
RUEDA DELANTERA

HO207P

Ø 47.99mm
h. 52.37mm
HOR207P



NISSAN ARMADA (05-07),
PATHFINDER ARMADA (04),
TITAN (04-15) 7945 D1041
RUEDA TRASERA

HO207R

Ø 59.90mm
h. 50.12mm
HOR207R



MERCURY VILLAGER (93-02),
NISSAN QUEST (93-02) 7456 D576,
RUEDA DELANTERA

HO207S

Ø 53.90mm
h. 49.00mm
HOR207S



HYUNDAI ELANTRA (02-05) 7843 D941, NISSAN
ALMERA (95-00) 78Y0 F323, LUCINO 1.6L (96-98)
7546 D668, MARCH (11-16) 8404 D1592, PULSAR
NX (83-90) 7155 D233, SENTRA (95-00), SENTRA
B13 CLASICO (90-91), SENTRA B14 (95-00)
SENTRA B16 AD WS (95-00) SENTRA GA 16
(95-00) 7546 D668, VERSA (12-19) 8804 D1592,
SUZUKI SIDEKICK (96-98) 7435 D556,
RUEDA DELANTERA

HO207T

Ø 47.38mm
h. 51.10mm
HOR207T



NISSAN NV350 URVAN (14-21) 8310
D1191, 8350 URVAN (02-13) 776X F198,
URVAN 3.0 (00-10) 8310 D1191,
RUEDA DELANTERA

PISTONES PARA CALIPER



NISSAN / FORD / HYUNDAI / SUZUKI / MAZDA / INFINITI

HO207U

Ø 53.86mm
h. 47.00mm
HOR207U



NISSAN AD WINGROAD (05-08) 8456 D1345, TIIDA (07-18) 8456 D1345, 7Y93 F302, VERSA NOTE (14-19) 8456 D1345, RUEDA DELANTERA

HO207W

Ø 51.03mm
h. 45.97mm
HOR207W



NISSAN AD VAGON (91-99), AVENIR SW (91-95), BLUEBIRD (91-99), PRIMERA (91-99), SENTRA B14 (95-00) 7386 D507 RUEDA DELANTERA

HO207X

Ø 60.48mm
h. 48.80mm
HOR207X



NISSAN PICK UP USA 2WD (84-91) PICK UP USA 4WD (84-91) 7171 D266 RUEDA DELANTERA

HO207Z

Ø 34.80mm
h. 45.00mm
HOR207Z



NISSAN SENTRA (07-12) 8405 D1288, JUKE (15-11) 8405 D1288, ROGUE (08-15) 8405 D1288, ALTIMA (07-10) 8405 D1288, ALTIMA (11-19) 8501 D1393, SENTRA (13-19) 8501 D1393, ROGUE (18-20) 8501 D1393, JUKE (13-15) 8501 D1393, RUEDA TRASERA

HO2400

Ø 57.10mm
h. 53.60mm
HOR2400



MAZDA PROTEGE (99-00) 7515 D637, RUEDA DELANTERA

HO2400A

Ø 44.25mm
h. 52.00mm
HOR2400A



NISSAN PATHFINDER (01-04) 7566 D855, QUEST (04-17) 7910 D855, 7566 D855, RUEDA DELANTERA

HO2401

Ø 50.65mm
h. 55.40mm
HOR2401



INFINITI QX56 (12-13), QX80 (14-20) 8403 D1509, NISSAN ARMADA (12-22) 8403 D1509, TITAN (07-22) 8403 D1286, 8403 D1509, RUEDA DELANTERA

HO2402

Ø 46.23mm
h. 50.85mm
HOR2402



NISSAN FRONTIER (02-15) 7703 D830, 7703 D830, 7703 D830, FRONTIER PRO 4X (15-20) 8200 D1900, NP300 (09-15) 7703 D830, PATHFINDER (05-12) 8200 D1094, XTERRA (00-15) 7703 D830, 8200 D1094, RUEDA DELANTERA

HO2403

Ø 53.90mm
h. 53.50mm
HOR2403



NISSAN KICKS (20-21), VERSA (20-21) 9269 D2038, MICRA (05-19) 8X48 F381, 8804 D1592, NOTE (14-16) 8804 D1592, VERSA NOTE (14-19), MARCH (12-21) 8404 D1592, RUEDA DELANTERA

HO2404

Ø 57.00mm
h. 53.50mm
HOR2404



GMC SIERRA 3500 HD DOBLE RODADO (11-15), NISSAN NV1500 (12-15), NV2500 (11-15), NV3500 (12-15), TITAN XD (16-19) 8773 D1565, RUEDA DELANTERA

HO2405

Ø 42.70mm
h. 49.00mm
HOR2405



NISSAN NV1500 (12-21), NV2500 (11-15), NV3500 (12-15), TITAN XD (16-19) 8773 D1565, RUEDA TRASERA

HO2406

Ø 47.90mm
h. 60.00mm
HOR2406



MERCEDES BENZ SPRINTER (04-15) 8383 D1268, CABSTAR (08-16) 8834 D1622, VOLKSWAGEN CRAFTER 3.5 TON (08-12) 8383 D1268 RUEDA DELANTERA

GMC / NISSAN / MERCEDES BENZ / VOLKSWAGEN / FORD / INFINITI / SUBARU / MAZDA / SUZUKI / HONDA / ACURA / DAEWOO / HYUNDAI / KIA

HO2407 Ø 48.00mm
h. 60.00mm
HOR2407

FORD TRANSIT (10-12) 7Y46 F338,
MERCEDES BENZ SPRINTER (07-15)
8432 D1318, **NISSAN CABSTAR (08-16)**
8835 D1487, **VOLKSWAGEN CRAFTER**
VAN (08-12) 8432 D1318,
RUEDA TRASERA

HO2408 Ø 34.00mm
h. 47.00mm
HOR2408

FIAT 500 (12-17) 8778 D1569, **NISSAN ALMERA (95-05)**, **ALTIMA (97-01)**, **BLUEBIRD (91-01)** 7533 D540, **HONDA CIVIC (05-15)** 7418 D537, **TOYOTA COROLLA (01-07)** 7696 D823, **FORD FOCUS (02-05)** 7883 D886, **INFINITI I30 (96-01)**, **I35 (02-04)**, **NISSAN MAXIMA (94-06)**, **SENTRA B15 (01-06)**, **SUNNY B14 (95-01)**, **SUNNY B15 (00-05)**, **SUNNY N16 (00-05)** 7533 D540, **SUZUKI SWIFT (10-20)**, **SX4 (10-13)** 9237 D2007, **RUEDA TRASERA**

HO2409 Ø 44.90mm
h. 50.50mm
HOR2409

NISSAN FRONTIER (16-19) 77W3
F521, **NAVARA (16-22)**, **NP300 (16-22)**
8200 D1911, **RUEDA DELANTERA**

HO2410 Ø 38.00mm
h. 51.00mm
HOR2410

NISSAN FRONTIER (05-19), **XTERRA (05-13)**
8206 D1100, **PHATFINDER (05-12)** 8204 D1101,
SUBARU OUTBACK (05-13), **IMPREZA (08-17)**,
WRX (13-15), **XV CROSSTREK (13-15)** 8218
D1114, **LEGACY (05-14)**, **MAZDA MPV (04-06)**
7978 D1073, **SUZUKI EQUATOR (09-12)** 8206
D1100 **RUEDA TRASERA**

HO2411 Ø 48.00mm
h. 44.70mm
HOR2411

INFINITI QX80 (14-20) 8719
D1510, **QX56 (11-13)** 8719 D1510,
ARMADA (17-22) 8719 D1510,
RUEDA TRASERA

HO2412 Ø 45.00mm
h. 50.00mm
HOR2412

CHEVROLET COLORADO (21-22)
9599 D2370, **GMC CANYON (21-22)**
9599 D2370, **RUEDA TRASERA**

HO209C Ø 50.61mm
h. 44.00mm
HOR209C

HONDA CIVIC (92-00)
NISSAN VANNETH (79-86)
7439 D560, **RUEDA DELANTERA**

HO209D Ø 57.01mm
h. 53.80mm
HOR209D

ACURA CL 3.0L (97-99), **INTEGRA (98-01)**, **LEGEND (91-95)**, **NSX (91-05)**, **RL (96-99)**, **VIGOR (92-94)**, **HONDA ACCORD COUPE (92-02)**, **CR-V (97-01)**, **PRELUDE (93-96)** 7382 D503, **RUEDA DELANTERA**

HO209G Ø 48.00mm
h. 48.50mm
HOR209G

DAEWOO TICO (90-97), **SUZUKI SWIFT (95-02)**, **GEO METRO (89-01)** 7331 D451, **HYUNDAI SANTA FE (07-09)** D1202, **KIA SEDONA (06-14)** 8322 D1202, **SUZUKI SWIFT (95-01)** 7331 D451, **RUEDA DELANTERA**

HO209R Ø 57.05mm
h. 53.60mm
HOR209R

AUDI A1 (18-20), **A3 (14-20)**, **A3 QUATTRO (15-18)**, **A3 SPORTBACK E-TRON (16-18)** 8849 D1760, **HONDA ACCORD HYBRID (06-08)**, **ACCORD V6 (03-10)** 7656 D787, **SEAT ATECA (17-20)**, **VW CADDY (15-20)**, **VW E-GOLF (15-19)**, **GOLF (15-21)**, **GOLF ALLTRACK (17-19)**, **GOLF SPORTWAGEN (10-13)**, **GOLF SPORTWAGEN (15-19)**, **GTI (16-18)**, **JETTA (19-22)** 8849 D1760, **ACURA CL 3.2L (01-05)** 7656 D787, **SEAT LEON (14-20)**, **VW PASSAT (18-21)**, **AUDI Q2 (18-20)**, **Q2 QUATTRO (18-20)** 8849 D1760, **ACURA RL (00-04)**, **TL (05-08)**, **TSX (04-14)** 7656 D787, **AUDI TT (16-18)**, **TT QUATTRO (16-21)** 8849 D1760, **RUEDA DELANTERA**

HO209T Ø 57.00mm
h. 47.45mm
HOR209T

HONDA ACCORD (03-10) 7795 D958
RUEDA DELANTERA

HO209Z Ø 56.90mm
h. 47.60mm
HOR209Z

ACURA ILX 2.4L (13-15), **HONDA ACCORD (13-17)**, **CIVIC (12-20)**, **CRV (02-17)**, **CRZ (12-16)**, **FIT (13-14)**, **ELEMENT (03-10)** 7795 D914, **RUEDA DELANTERA**

PISTONES PARA CALIPER



ACURA / HONDA / SUZUKI / FIAT

HO900H

Ø 30.00mm
h. 45.00mm
HOR900H



**HONDA CIVIC (92-00) D564,
ACURA TSX (04-08) D536,
ACURA INTEGRA (90-99)
RUEDA TRASERA**

HO900J

Ø 51.00mm
h. 43.20mm
HOR900J



**SUZUKI JIMNY (90-98) 7332 D452,
SWIFT (92-94) 7180 D277,
RUEDA DELANTERA**

HO2100

Ø 56.95mm
h. 54.48mm
HOR2100



**HONDA CIVIC DX (96-05) 7573 D465,
RUEDA DELANTERA**

HO2102

Ø 63.37mm
h. 48.45mm
HOR2102



**HONDA PILOT (03-08) 7844 D943,
RUEDA DELANTERA**

HO2105

Ø 64.22mm
h. 51.75mm
HOR2105



**ACURA MDX (01-06)
HONDA ODYSSEY (99-04) 7663 D793,
RUEDA DELANTERA**

HO7500

Ø 53.85mm
h. 50.00mm
HOR7500



**FIAT UNO (14-17) 8722 D1513,
RUEDA DELANTERA**

HO2108

Ø 53.77mm
h. 47.35mm
HOR2108



**HONDA CIVIC EX (96-05) 7573 D465,
RUEDA DELANTERA**

HO2109

Ø 38.00mm
h. 46.20mm
HOR2109



**ACURA CL 2.2L, CL 3.0L (97-99), CL 3.2L (01-03)
7418 D536, ILX 1.5L (13-15), ILX 2.4L (13-15) 7418
D537, ILX HYBRID (13-14) 7418 D536, INTEGRA
(98-01) 7418 D537, LEGEND (91-95), RL (00-04), RL
(96-99) 7418 D536, RSX (02-06) 7418 D537, TL T/A
(05-08), TL T/M (04-06), TL TYPE S (07-08) 7418 D536,
TSX (04-08), VIGOR (92-94) 7418 D537, HONDA CRV
(97-04) 7418 D536, 7418 D1086, ELEMENT (03-10)
7418 D536, ACCORD CROSSTOUR (10-11) 7418
D1086 RUEDA TRASERA**

HO2110

Ø 45.29mm
h. 53.80mm
HOR2110



**HONDA CROSSTOUR (12-15), CRV (07-16),
ODYSSEY (08-17) 7994 D1089, 7994 D1521,
PASSPORT (20-21) 7994 D1521, LAND ROVER
DISCOVERY SPORT (13-21) 7994 D2133,
RANGE ROVER (10-16), ROVER LR4 (10-16)
7994 D1479, ROVER RANGE ROVER EVOQUE
(18-20) 7994 D2133, RUEDA DELANTERA**

HO2111

Ø 42.73mm
h. 44.70mm
HOR2111

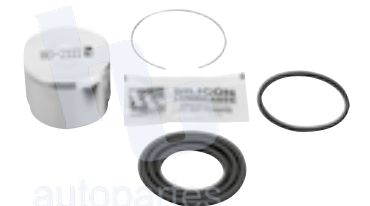

**HONDA PASSPORT (19-21), PILOT (19-21),
RIDGELINE (17-21), ACURA MDX (14-16),
8697 D1724, RUEDA TRASERA**

HO2112

Ø 47.50mm
h. 48.60mm
HOR2112



**HONDA PILOT (09-21), RIDGELINE (18-21),
ACURA MDX (15-20), 8396 D1723,
RUEDA DELANTERA**

HO2113

Ø 57.00mm
h. 51.00mm
HOR2113



**HONDA ACCORD (13-20) 8883 D1654,
HRV (16-21) 8883 D1654, RUEDA
DELANTERA**

PISTONES PARA CALIPER

DAEWOO / SUZUKI / CHEVROLET / HYUNDAI / KIA / SSANGYONG / FORD / HYUNDAI

HO2200 Ø 50.96mm
h. 43.98mm
HOR2200

**DAEWOO DAMAS (80-81) 7104 D177,
RUEDA DELANTERA**

HO2502 Ø 51.05mm
h. 46.22mm
HOR2502

**NISSAN SAMURAI (85-87) 7100 D244,
RUEDA DELANTERA**

HO211F Ø 60.20mm
h. 45.50mm
HOR211F

**CHEVROLET LUV (97-05), ISUZU
TROOPER PICK UP (92-95)
7347 D363, RUEDA DELANTERA**

HO212E Ø 51.00mm
h. 44.50mm
HOR212E

**DODGE ATOS (01-12) 8253 D1142,
8258 D1148, 7X37 F138, 7Y02 F208
RUEDA DELANTERA**

HO212H Ø 59.93mm
h. 51.50mm
HOR212H

**HYUNDAI GRACE (93-04),
H100 (93-04), PORTER (93-04) 7X52
F004, 8247 D1072, 8247 D1137,
RUEDA DELANTERA**

HO212L Ø 53.80mm
h. 48.50mm
HOR212L

**HYUNDAI ACCENT (94-05), GETZ (02-
06), SCOUPE (93-95), VERNA (04-06)
7293 D440, RUEDA DELANTERA**

HO900A Ø 53.85mm
h. 46.70mm
HOR900A

**KIA RIO (03-05), SPECTRA (04-05)
7767 D889, RUEDA DELANTERA**

HO900B Ø 50.94mm
h. 44.63mm
HOR900B

**KIA RIO (01-02) 7219 D466,
RUEDA DELANTERA**

HO900C Ø 53.85mm
h. 49.40mm
HOR900C

**KIA SPORTAGE (95-97) 7550 D670,
RUEDA DELANTERA**

HO900D Ø 38.05mm
h. 49.20mm
HOR900D

**HYUNDAI ELANTRA (00-10), SANTA FE
(01-06) 7688 D863, SONATA (01-09) 7688
D813, KIA LOTZE (03-09), SSANGYONG
ACTION, KYRON, REXTON (03-09)
7688 D863, RUEDA TRASERA**

HO900E Ø 48.00mm
h. 45.00mm
HOR900E

**FORD FIESTA (88-93),
KIA PRIDE (88-93) 7291 D402,
RUEDA DELANTERA**

HO900F Ø 42.80mm
h. 49.00mm
HOR900F

**HYUNDAI SANTA FE (01-06) 7739
D864, STAREX (92-98), TERRACAN
(98-00) 7739 D1104, RUEDA
DELANTERA**

PISTONES PARA CALIPER



ISUZU / MAZDA / MERCEDES BENZ / MITSUBISHI / RENAULT / PEUGEOT

HO2508

Ø 57.00mm
h. 54.00mm
HOR2508



ISUZU NPR (05-10) 7699 D827,
RUEDA DELANTERA

HO2508A

Ø 50.60mm
h. 53.70mm
HOR2508A



ISUZU ELF200 (09-13) 8924 D1700,
RUEDA DELANTERA

HO2519

Ø 53.75mm
h. 55.00mm
HOR2519



ISUZU ELF 300 (10-14), ELF 400 (06-14),
ELF 500 (09-14), ELF 600 (09-14),
NPR (98-07), NQR (98-07) 7697 D825
RUEDA DELANTERA

HO209A

Ø 53.86mm
h. 45.40mm
HOR209A



MAZDA B2200 (87-93), B2500 (98-01),
B2600 (87-93), B2600 2WD (87-03),
B2600 4X4 (87-03), PICK UP B2000 (86-93)
7220 D320,
RUEDA DELANTERA

HO209E

Ø 45.85mm
h. 51.00mm
HOR209E



MAZDA B2300 PICK UP (94-10),
B2500 (98-01), B3000 (94-04),
B4000 (94-04) 7532 D652,
RUEDA DELANTERA

HO209M

Ø 59.93mm
h. 49.80mm
HOR209M



MERCEDES BENZ ML 320 (98-02)
350 (03-05) 7628 D760, RUEDA
DELANTERA

HO2800

Ø 45.00mm
h. 56.50mm
HOR2800



DODGE SPRINTER 2500, 3500 (03-06),
MERCEDES BENZ SPRINTER 416, 431 (04-06)
7848 D949, RUEDA DELANTERA

HO209F

Ø 42.74mm
h. 45.00mm
HOR209F



MITSUBISHI MONTERO (92-00)
MONTERO SPORT (97-04) 7412 D530
RUEDA DELANTERA

HO209N

Ø 53.84mm
h. 53.50mm
HOR209N



RENAULT MAGANE (01-10) 7Y01
F207, SCENIC (01-04) 8255 D1145,
RUEDA DELANTERA

HO209P

Ø 47.93mm
h. 50.50mm
HOR209P



PEUGEOT 206 (00-02),
306 (97-02) 76X3 F134
RUEDA DELANTERA

HO209W

Ø 54.00mm
h. 50.00mm
HOR209W



PEUGEOT 306 (97-02) 76X3 F134,
RENAULT KANGOO (07-09), KANGOO
EXPRESS (04-19) 8254 D1499,
76X3 F134, RUEDA DELANTERA

HO209X

Ø 53.81mm
h. 53.50mm
HOR209X



PEUGEOT PARTNER (04-05)
723X F027, RUEDA DELANTERA

CHRYSLER / JEEP / DODGE / MITSUBISHI / PEUGEOT / RENAULT / TOYOTA

HO2300 Ø 60.03mm
h. 48.04mm
HOR2300

CHRYSLER SEBRING (95-05) 7365 D484, 7741 D866, **FAW GF 1500 (15-16)** 7365 D484, **JEEP COMPASS (07-14)** 7741 D866, **PATRIOT (07-14)**, **MITSUBISHI ASX (14-15)** 7741 D866, **ECLIPSE (95-09)**, **GALANT (88-10)** 7365 D484, 7741 D866, **RUEDA DELANTERA**

HO2302 Ø 60.45mm
h. 48.55mm
HOR2302

MITSUBISHI L200 (06-20) 8728 D1519, **RUEDA DELANTERA**

HO2700 Ø 53.82mm
h. 48.00mm
HOR2700

MITSUBISHI CEDIA (02-04), **LANCER (02-08)** 7782 D904, **RUEDA DELANTERA**

HO2701 Ø 44.22mm
h. 45.50mm
HOR2701

CHRYSLER 200 (12-14), **SEBRING (07-10)**, **DODGE AVENGER (08-14)**, **JEEP COMPASS, PATRIOT (09-16)**, **MITSUBISHI ENDEAVOR (04-11)**, **LANCER (08-14)**, **MONTERO (01-06)**, **OUTLANDER (07-13)** 7743 D868, **RUEDA TRASERA**

HO2702 Ø 45.30mm
h. 45.70mm
HOR2702

MITSUBISHI MONTERO (01-06) 7742 D867, **RUEDA DELANTERA**

HO2900 Ø 53.84mm
h. 53.50mm
HOR2900

PEUGEOT 206 (03-07) 775Y F222, **RENAULT MEGANE II (05-08)** 7Y21 F253, **RUEDA DELANTERA**

HO2901 Ø 53.95mm
h. 50.00mm
HOR2901

RENAULT CAPTUR (18-20), **OROCH (19-20)**, **DUSTER (13-19)**, **FLUENCE (11-14)** 8844 D1627, **RUEDA DELANTERA**

HO2902 Ø 42.70mm
h. 46.30mm
HOR2902

MITSUBISHI MONTERO SPORT (01-06) 7602 D733, **RUEDA TRASERA**

HO2903 Ø 40.96mm
h. 51.00mm
HOR2903

RENAULT TRAFIC 1.9L (07-15) 7681 D808, **RUEDA TRASERA**

HO2904 Ø 53.95mm
h. 58.00mm
HOR2904

MG 5 (20-22) 7709 D768, **RUEDA DELANTERA**

HO207TC Ø 33.90mm
h. 28.50mm
HOR207TC

TOYOTA HILUX 4X4 (89-95) 7298 D436, **LAND CRUISER (76-90)**, **PICK UP (79-87)**, **PRADO (76-90)** 7069 D137, **RUEDA DELANTERA**

HO207TG Ø 42.79mm
h. 28.00mm
HOR207TG

TOYOTA 4RUNNER (01-02) 7298 D436, **HILUX (89-95)** 7549 D436, **HILUX 4X4 (89-95)** 7298 D436, **LAND CRUISER (76-90)** 7069 D137, **PICK UP (89-95)** 7298 D436, **PRADO (76-90)** 7069 D137, **TACOMA (95-04)** 7549 D436, **RUEDA DELANTERA**

PISTONES PARA CALIPER



MITSUBUSHI / TOYOTA / GREAT WALL / CHANGHE / DAIHATSU / HYUNDAI

HO209B

Ø 57.10mm
h. 46.00mm
HOR209B



TOYOTA HILUX 4X4 (85-95),
PICK UP (85-88) 7127 D207,
RUEDA DELANTERA

HO209H

Ø 57.12mm
h. 46.00mm
HOR209H



MITSUBISHI MONTERO (88-91),
TOYOTA CALDINA (93-06), CAMRY (93-01),
CELICA (94-97), COROLLA (93-97),
CORONA 3S (94-97), IPSUM (93-06),
RAV4 (01-02), SCION TC (05-06)
7241 D349, RUEDA DELANTERA

HO209I

Ø 60.26mm
h. 48.50mm
HOR209I



CHANGHE UNIVERSAL, GREATWALL
C (06-07), JINBEI UNIVERSAL, TOYOTA
HIACE (89-97), HILUX (89-92) 7205 D438,
RUEDA DELANTERA

HO209J

Ø 48.00mm
h. 48.50mm
HOR209J



GREAT WALL HAVAL H3, GREAT
WALL HAVAL H5 (05-10), TOYOTA
4RUNNER (03-15) 7487 D606,
RUEDA TRASERA

HO209K

Ø 53.00mm
h. 45.00mm
HOR209K



DAIHATSU CHARADE (88-92),
HYUNDAI ACCENT (95-99), TOYOTA
CELICA (86-91), COROLLA (81-92),
PASEO (92-99), TERCEL (86-99)
7153 D242, RUEDA DELANTERA

HO209L

Ø 60.23mm
h. 48.00mm
HOR209L



TOYOTA AVALON (98-99)
7581 D707, RUEDA DELANTERA

HO209S

Ø 51.00mm
h. 57.00mm
HOR209S



TOYOTA COASTER (95-03)
78X3M F065, RUEDA DELANTERA

HO209U

Ø 53.83mm
h. 47.95mm
HOR209U



TOYOTA YARIS (01-07) 8301 D1184
RUEDA DELANTERA

HO2000

Ø 51.03mm
h. 45.97mm
HOR2000



TOYOTA CALDINA (93-06), COROLLA
BRASIL (93-06), CORONA 3S (98-00),
PROBOX (99-00), YARIS (04-05), ECHO
(01-05) 7704 D831, RUEDA DELANTERA

HO2001

Ø 60.18mm
h. 49.05mm
HOR2001



TOYOTA AVALON (97-06) 7581 D707,
CAMRY (91-01) 7581 D707, 7357 D476,
COROLLA (10-18) 8969 D1210, RAV4
(02-10), SIENNA (04-10), SOLARA (99-
03) 7581 D707, RUEDA DELANTERA

HO2003

Ø 38.00mm
h. 40.00mm
HOR2003



TOYOTA CAMRY (07-15) 8332 D1212,
RUEDA TRASERA

HO2004

Ø 63.30mm
h. 52.75mm
HOR2004



TOYOTA CAMRY (02-07)
8331 D1222, 7787 D908,
RUEDA DELANTERA

PISTONES PARA CALIPER

SUZUKI / TOYOTA / KING LONG / GREAT WALL

HO2006 Ø 42.80mm
h. 49.50mm
HOR2006

TOYOTA CAMRY (95-96) 7357 D697,
RUEDA DELANTERA

HO2012 Ø 60.50mm
h. 50.00mm
HOR2012

SUZUKI GRAND VITARA (06-13)
8307 D1188, **TOYOTA CRESSIDA**
LX80 (89-92) 7069 D433, **PICK UP**
T100 2WD (93-95) 7485 D604,
RUEDA DELANTERA

HO2013 Ø 66.57mm
h. 48.20mm
HOR2013

KING LONG KINGO (98-05) 7205
D303, **TOYOTA HIACE (06-20)**, **HIACE**
(93-05) 8552 D1434, 7Y30 F274,
RUEDA DELANTERA

HO2014 Ø 45.32mm
h. 28.69mm
HOR2014

TOYOTA LAND CRUISER (91-97),
PRADO (91-97) 7298 D502,
RUEDA DELANTERA

HO2015 Ø 42.76mm
h. 31.20mm
HOR2015

TOYOTA HILUX (05-13) 7877 D976,
LAND CRUISER (99-07), **PRADO (99-07)** 7639 D772, RUEDA DELANTERA

HO2016 Ø 45.30mm
h. 31.30mm
HOR2016

GREAT WALL HAVAL H3, H5 (05-10),
TOYOTA 4RUNNER (03-15), **FJ CRUISER**
(07-14) 7877 D976, **HIGHLANDER (14-19)**
8636 D1324, **HILUX VIGO (13-17)** 8776
D1567, **SEQUOIA (03-07)**, **TACOMA (05-15)**, **TAI LANDESS (08-10)** 7877 D976,
RUEDA DELANTERA

HO2017 Ø 60.38mm
h. 51.50mm
HOR2017

TOYOTA RAV4 (00-05) 7738 D862,
RUEDA DELANTERA

HO2018 Ø 60.26mm
h. 48.50mm
HOR2018

TOYOTA NOAH (93-06) 7167 D263,
RUEDA DELANTERA

HO2019 Ø 38.00mm
h. 44.40mm
HOR2019

TOYOTA RAV4 (06-15) 8332 D1212,
RUEDA TRASERA

HO2020 Ø 31.82mm
h. 47.30mm
HOR2020

TOYOTA RAV4 (04-05) 7955 D1051,
RUEDA TRASERA

HO2021 Ø 53.73mm
h. 47.90mm
HOR2021

TOYOTA YARIS (16-19) 9081 D1852,
RUEDA DELANTERA

HO2022 Ø 40.40mm
h. 30.00mm
HOR2022

TOYOTA SIENNA (10-11) 8500 D1391,
RUEDA TRASERA

PISTONES PARA CALIPER



TOYOTA / VOLKSWAGEN / SEAT / CHEVROLET / AM GENERAL / PEUGEOT / RENAULT

HO2023 Ø 45.00mm
h. 52.00mm
HOR2023

**TOYOTA LAND CRUISER (08-21),
LEXUS LX 570 (18-21) 8420 D1304,
RUEDA TRASERA**

HO2024 Ø 51.00mm
h. 31.00mm
HOR2024

**TOYOTA LAND CRUISER (08-20),
SEQUOIA (08-20) TUNDRA (07-20),
LEXUS LX 570 (08-20) 8419 D1303,
RUEDA DELANTERA**

HO2025 Ø 48.00mm
h. 31.00mm
HOR2025

**TOYOTA 4RUNNER (10-20) 7877 D976,
LAND CRUISER (98-07) 7636 D772,
RUEDA DELANTERA**

HO2026 Ø 45.35mm
h. 48.50mm
HOR2026

**TOYOTA 4RUNNER (10-20),
FJ CRUISER (07-14) 7487 D606,
RUEDA TRASERA**

HO214 Ø 53.94mm
h. 33.30mm
HOR214

**VOLKSWAGEN COMBI PANEL (73-01)
7021 D45, RUEDA DELANTERA**

HO214A Ø 43.90mm
h. 53.80mm
HOR214A

**VOLKSWAGEN ATLANTIC (84-97)
CARIBE (77-87), 7031 D96
RUEDA DELANTERA**

HO214B Ø 39.95mm
h. 29.00mm
HOR214B

**VOLKSWAGEN BRASILIA (74-82) 755
D21, SEDAN (95-04) 755 D30,
RUEDA DELANTERA**

HO214C Ø 47.90mm
h. 52.40mm
HOR214C

**VW ATLANTIC (84-87), CARIBE (84-87)
CORSAR (84-88) 7183 D569, 7183 D280,
7209 D280, DERBY (97-05) 7569 D694,
GOL (09-20) 8868 D1641, GOLF (87-99),
JETTA (87-99) 7183 D569, 7183 D280,
7209 D280, 7569 D694, SAVEIRO (12-20),
UP! (16-18) 8868 D1641
RUEDA DELANTERA**

HO214D Ø 53.85mm
h. 54.00mm
HOR214D

**VW CABRIOLET (85-93) 7177 D227,
SEAT CORDOBA (03-09), VW GOLF (92-07),
VW JETTA (92-05), SEAT IBIZA (01-07) 7177
D227, 7578 D704, VW DERBY (98-09) 7578
D704, CHEVROLET ONIX (21-23) 9611 D2385,
78Y1 F565, VW PASSAT (90-94) 7177 D227,
POLO (03-21) 7Y09 F221, VW VAN (03-05)
7578 D704, VENTO (14-21) 9006 D1776,
RUEDA DELANTERA**

HO214E Ø 53.94mm
h. 46.50mm
HOR214E

**CHEVROLET CHEVY PICK UP (99-03)
VOLKSWAGEN CROSSFOX (07-17)
GOL (09-13), POINTER TRUCK (99-09)
8284 D1173, RUEDA DELANTERA**

HO214F Ø 38.00mm
h. 51.00mm
HOR214F

PEUGEOT 208 (14-15) 7234 D340, 306 (97-02), 307 (03-10), 405 (97-99) 7335 D340,
FIAT 500X (16-20) 9044 D1809, AUDI A4 (97-05), A6 (00-03), A8 (97-00), ALLROAD
QUATTRO (01-03), SEAT ALTEA (08-15), VOLKSWAGEN BEETLE (99-07) 7335
D340, CHEVROLET BOLT EV (17-19) 9085 D1857, VW BORA (05-10), CABRIOLET
(85-93) 7335 D340, VW CC (09-12) 8213 D1548, 8213 D1108, SEAT CORDOBA (03-
09) 7335 D340, TOYOTA COROLLA (09-20) 8463 D1423, CHEVROLET EQUINOX
(18-22) 9085 D1915, RENAULT FLUENCE (11-14), VW DERBY (02-05) 7234 D340,
VW GOLF (97-20) 7234 D340, 7335 D340, HONDA HR-V (21-22) 9069 D1841, SEAT
IBIZA (03-16), LEON (01-07) 7335 D340, VW JETTA (93-20), RENAULT MEGANE
(01-10) 7234 D340, 7335 D340, BUICK LACROSSE (17-19), CHEVROLET MALIBU
(18-22) 9085 D1915, 9146 D1921, VW PASSAT (91-09) 7234 D340, 7335 D340, 8213
D1108, VW POLO (03-17), 7335 D340, DODGE RAM PROMASTER 3500 (19-20)
9068 D1840, BUICK REGAL SPORTBACK (18-20), REGAL TOURX (18-20) 9085
D1915, JEEP RENEGADE (15-22) 9044 D1809, NISSAN ROGUE (19-20), ROGUE
SPORT (19-20) 9190 D19965, AUDI S4 (00-01), S6 (01-02) 7335 D340, VOLVO
S60 (11-18), S60 CROSS COUNTRY (16-18), S80 SERIES (07-16) 8422 D1307,
RENAULT SCENIC (01-08) 7234 D340, 7335 D340, GMC TERRAIN (10-22) 9085
D1915, SEAT TOLEDO (01-06), AUDI TT (00-06) 7335 D340, VOLVO V60, V60
CROSS COUNTRY (15-18), V70 (08-10), XC60 (10-17), XC70 (08-16) 8422 D1307,
CHEVROLET VOLT (16-19) 9085 D1857, RUEDA TRASERA

HO214G Ø 47.94mm
h. 53.09mm
HOR214G

**VOLKSWAGEN POINTER (02-09)
POINTER PICK UP (99-07)
7242 D350, RUEDA DELANTERA**

* TODOS LOS PISTONES INCLUYEN LIGA Y SILICÓN

*Ø. = DIÁMETRO EXTERIOR
*h. = ALTURA
*CE. = CÓDIGO EQUIVALENTE

MERCEDES / NISSAN / VOLKSWAGEN / AUDI / KIA / HYUNDAI / DODGE

HO214H

Ø 52.00mm
h. 59.00mm
HOR214H



MERCEDES BENZ SPRINTER 3500 (07-15) 8383 D1268, **NISSAN CABSTAR (05-13)** 79W2 F308, **VOLKSWAGEN CRAFTER 5 TON (08-12)** 8383 D1268, **RUEDA DELANTERA**

HO214K

Ø 47.95mm
h. 52.00mm
HOR214K



VOLKSWAGEN AMAROK (10-16) 8767 D1555, **RUEDA DELANTERA**

HO214L

Ø 53.93mm
h. 55.00mm
HOR214L



AUDI A3 (07-16), **SEAT ALTEA (06-15)** 8212 D1107, **CORDOBA (03-09)**, **IBIZA (03-14)**, **LEON (02-08)**, **TOLEDO (01-07)** 7709 D768, **VOLKSWAGEN BEETLE (00-16)** 8212 D1107, 7635 D768, **CC (10-12)**, **GOLF (00-16)**, **JETTA (00-18)** 7635 D768, 8212 D1107, **GOLF SPORTWAGEN (15-18)**, **GTI (09-11)**, **PASSAT (08-09)** 8212 D1107, **RUEDA DELANTERA**

HO70600

Ø 60.00mm
h. 46.00mm
HOR70600



KIA K2700, K3000 (06-16) 8751 D1543, **RUEDA DEL Y TRA**

HO70602

Ø 57.00mm
h. 51.00mm
HOR70602



HYUNDAI ELANTRA (17-19) 9143 D1912, **FORTE KOUP (14-16)** 8904 D1827, **VELOSTER (16-17)** 8810 D1828, 8904 D1827, **NIRO (17-18)** 9143 D1912, **RUEDA DELANTERA**

HO70603

Ø 50.90mm
h. 45.00mm
HOR70603



DODGE ATTITUDE (12-14), **HYUNDAI ELANTRA (14-16)** 8810 D1595, **KIA FORTE (14-18)** 8751 D1543, **FORTE KOUP (14-16)** 8810 D1595, **RUEDA DELANTERA**

HO70604

Ø 60.45mm
h. 53.00mm
HOR70604

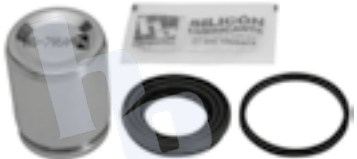

HYUNDAI IX35 (15) 9050 D1295, **KONA ELECTRIC (20-21)** 9035 D1826, **SONATA (15-19)** 9050 D1295, 9035 D1826, **TUCSON (10-16)**, **KIA CADENZA (14-16)** 9050 D1295, **OPTIMA (16-17)** 9035 D1826, **SOUL EV (15-17)** 9050 D1295, **RUEDA DELANTERA**

HO70605

Ø 33.87mm
h. 45.10mm
HOR70605



HYUNDAI AZERA (06-09), **TUCSON (05-09)**, **XG300 (01)**, **XG350 (01-02)**, **AMANTI (04-06)**, **OPTIMA (06-10)**, **SPORTAGE (05-10)** 7688 D813, **RUEDA TRASERA**

HO70606

Ø 38.10mm
h. 46.60mm
HOR70606



KIA CADENZA (17-20) 9280 D2050, **RUEDA TRASERA**

HO70607

Ø 59.90mm
h. 51.60mm
HOR70607



HYUNDAI TUCSON (16-21), **KIA SPORTAGE (17-20)** 9075 D1847, **RUEDA DELANTERA**

HO70608

Ø 33.90mm
h. 46.99mm
HOR70608



HYUNDAI TUCSON (10-15), **KIA SPORTAGE (11-16)** 8506 D1398, **RUEDA TRASERA**

HO70609

Ø 30.83mm
h. 46.80mm
HOR70609



HYUNDAI ACCENT (06-07), **ELANTRA (09-12)**, **KIA FORTE (10-13)**, **FORTE KOUP (10-13)**, **RIO (06-07)** 8267 D1157, **RUEDA TRASERA**

PISTONES PARA CALIPER



SUZUKI / RENAULT / KIA / HYUNDAI

HO70610

Ø 34.00mm
h. 46.00mm
HOR70610



KIA NIRO (16-22) 8428 D1812, NIRO (16-17) 8428 D1812, NIRO (17-21) 8428 D1812, NIRO (18-21) 8428 D1812, RIO (11-17) 8428 D1544, RIO (17-20) 8428 D1544, RIO (17-18) 8428 D1544, RIO (12-22) 8428 D1544, RIOS (12) 8428 D1544, HYUNDAI ACCENT (10-17) 8428 D1812, ACCENT (10-11) 8428 D1812, ACCENT (18-19) 8428 D1812, ELANTRA (11-16) 8428 D1544, ELANTRA (11-15) 8428 D1544, ELANTRA (10-11) 8428 D1544, ELANTRA (17-20) 8428 D1812, ELANTRA (11-16) 8428 D1544, ELANTRA (13-15) 8428 D1544, ELANTRA (18-20) 8428 D1812, ELANTRA (18) 8428 D1812, ELANTRA (20) 8428 D1812, ELANTRA (18) 8428 D1812, IONIQ (16-17) 8428 D1812, IONIQ (17-20) 8428 D1812, IONIQ (18-21) 8428 D1812, IONIQ (20) 8428 D1812, IONIQ (18-19) 8428 D1812, ACCENT (18-20) 8428 D1812, ACCENT (12-17) 8428 D1544, VENUE (20-22) 8428 D1812, RUEDA TRASERA

HO70611

Ø 34.00mm
h. 47.00mm
HOR70611



HYUNDAI ELANTRA GT (17), 8428 D1813, KONA (17-18) 8428 D1813, VELOSTER (17) 8428 D1813, VELOSTER (16) 8428 D1813, KIA FORTE (17-18) 8428 D1813, FORTE (18) FORTE (17) 8428 D1813, FORTE5 (17-18) 8428 D1813, FORTE5 (17-18) 8428 D1813, SELTOS (21-22) SOUL (17-19) 8428 D1813, RUEDA TRASERA

HO70612

Ø 38.00mm
h. 49.00mm
HOR70612



HYUNDAI ix35 (13-15) 8614 D1295, KONA ELECTRIC (19-21) 8428 D1813, SONATA(16-19) 8428 D1813, KIA CADENZA (20-17) 9283 D2098, NIRO EV (19-21) 8428 D1813, OPTIMA (16) 8428 D1813, OPTIMA (17-20) 8428 D1813, SOUL EV (17-19) 8428 D1813, SPORTAGE (19-20) 9283 D2098, TUCSON (18-21) 9283 D2098, MG ZS (20-22) 7335 D340, ZS (20-22) 7335 D340, ZS (20-22) 7335 D340, RUEDA TRASERA

HO70800

Ø 50.90mm
h. 45.00mm
HOR70800



RENAULT KWID (19-23) 82Y2 F564, RUEDA DELANTERA

HO70900

Ø 53.85mm
h. 47.30mm
HOR70900



SUZUKI APV (93-97) 8671 D1471 RUEDA DELANTERA

HO900S



LUBRICANTE DE SILICÓN PARA CALIPER DE 1/8 DE OZ. UNIVERSAL

HO900SP



LUBRICANTE DE SILICÓN PARA CALIPER DE 50 GR. UNIVERSAL

HO632



PRENSA PARA PISTONES DE CALIPER UNIVERSAL



HOAUTOPARTES.MX

Encuentra éstas y miles de aplicaciones más en:

hoautopartes.mx

ÍNDICE DE REPUESTOS SIN PISTÓN

CÓDIGO	APLICACIÓN	DIÁMETRO	BALATA	CUBRE POLVO
HOR208W	FORD EXPLORER SPORT TRAC (03-05), EXPLORER (01-05), MERCURY MOUNTAINER (01-05)	36.00 MM	7504 D627	BLANDO
HOR208X	FORD MUSTANG (05-09) RUEDA TRASERA	42.00 MM	7987 D1082	DURO
HOR208Z	FORD FUSION (06-09), LINCOLN MKZ (07-09), MAZDA 6 (06-09) RUEDA TRASERA	34.00 MM	8772 D1161	BLANDO
HOR213X	CHRYSLER TOWN&COUNTRY (08-09), DODGE CARAVAN (08-09), JOURNEY (09), VW ROUTAN (09) RUEDA TRASERA	42.00 MM	8438 D1326	DURO
HOR900G	HONDA PASSPORT (94-01), ISUZU AMIGO (94-00), RODEO (93-02), RODEO SPORT (01-03), TROOPER (92-97) RUEDA TRASERA	42.00 MM	7460 D580	BLANDO
HOR2301	MITSUBISHI ECLIPSE (95 01-06) GALANT	36.00 MM	7365 D484	BLANDO
HOR2500	CHEVROLET EQUINOX (07-09) RUEDA TRASERA	38.00 MM	8391 D1275	BLANDO
HOR2501	CHEVROLET HHR (08-09), MALIBU (07-09) RUEDA TRASERA	38.00 MM	8286 D1033	BLANDO
			8474 D1364	
HOR2516	CHEVROLET SAIL (15-16) RUEDA DELANTERA	52.00 MM	8692 D1492	BLANDO
HOR2600	NISSAN ALTIMA MAXIMA (90-03)	34.00 MM	7777 D900	BLANDO

Encuentra éstas y miles de aplicaciones más en:

hoautopartes.mx

TORNILLOS PARA CALIPER



Diámetro exterior buje (Ø b.)

Diámetro Cabeza (Ø c.)
Longitud (L.)

HO096H *BALATAS 7170 D265*
Øc. 10 mm
L. 76 mm
Øc. 14 mm

NISSAN DATSUN PICK-UP (89-92), ICHI VAN (88-94)

HO097H *BALATAS 7170 D265*
Øc. 12 mm
L. 71 mm
Øc. 14 mm

NISSAN DATSUN PICK-UP (89-92) ICHI VAN (87-94)

HO097HA *BALATAS 7403A D521 7404A D522 7406 D524 7518A D642*
Øc. 12.70 mm
L. 76 mm
Øc. 14 mm

CHRYSLER SHADOW (88-90), SPIRIT (89-95) DODGE NEON (95-97)

HO099H Corto L. **53 mm**

VW CORSAR (84-88), VW GOLF (87-92) y (98-99), VW JETTA (90-92) y (98-99), 7X83 D569, 7183 D280, 7209 D280, 7569 D694/694A

HO099HA Largo L. **73 mm**

VW CORSAR (84-88), VW GOLF (87-92) y (98-99), VW JETTA (90-92) y (98-99), 7X83 D569, 7183 D280, 7209 D280, 7569 D694/694A

HO099HM Mediano L. **63 mm**

VW CORSAR (84-88), VW GOLF (87-92) y (98-99), VW JETTA (90-92) y (98-99), 7X83 D569, 7183 D280, 7209 D280, 7569 D694/694A

HO100H *BALATAS 7172 D152*
L. **53 mm (NAC)**
Øc. **7/16"**
L. **90 mm (USA)**

FORD FAIRMONT (79-83) (LARGO) MUSTANG (79-92) (LARGO)

HO100HCTO *BALATAS 7072B D181*
Øc. **11.10 mm**
L. **77 mm**

FORD FAIRMONT (78-83) (CORTO)

HO100HA *BALATAS 7082A D150 7082E D346*
Øc. **17.45 mm**
L. **105 mm**

FORD CROWN VICTORIA (79-81) GALAXIE 500 (74-73), LTD (78-84) MERCURY GRAND MARQUIS (81-93)

HO100HB *BALATAS 771 D120*
Øc. **16 mm**
L. **95 mm**
Øb. **12 mm**

FORD F350 (68-95)

HO100HD *BALATAS 7106 D257*
L. **55 mm**
Øb. **12 mm**

FORD TOPAZ (84-94), GHIA (91-93), TEMPO (90-94)

HO313 *BALATAS 7054 D120*

BUJE FORD F350 (68-95)

HO313A

RESORTE FORD F350 (68-95)

HO100HE *BALATAS MEDIDAS 7072B D310*
Øc. **14 mm**
L. **101 mm**

FORD THUNDERBIRD (89-92) MERCURY COUGAR (89-92)

HO100HF *BALATAS MEDIDAS 7054 D120*
Øc. **13.50 mm**
L. **37 mm**

FORD F150, F250 (91-92), E350 ECONOLINE (75-85), E150, E250, E350 (75-85)

HO101HB *BALATAS 7134 D220*
MEDIDAS
Øb. **12.70 mm**
L. **63 mm**

DODGE DART (82-89)

HO101HC

BALATAS
7403A D521
71X5 F013
MEDIDAS
Øb. 12.70 mm
L. 63 mm



DODGE SPIRIT (90-95)
NISSAN TSURU (84-91)

HO102

CHEVROLET (L. 112 mm)
BALATAS
728 D52



CHEVROLET C10 (75-86), C30 (75-81)

HO102L

CHEVROLET (L. 119 mm)
BALATAS
728 D52



C10 (75-86), C30 (75-81)

HO102CTO

CHEVROLET CORTO (L. 107 mm)
BALATAS
728 D52



C10 (75-86), C30 (75-81)

HO102B

BALATAS
70X0 D183
7070C D183
7136 D215
MEDIDAS
Øc. 16 mm
L. 78 mm
Øb. 16 mm



BUICK CENTURY (84-89)
CHEVROLET CELEBRITY (82-90)
OLDSMOBILE SILHOUETTE (90-91)

HO102C

BALATAS
7259 D369
7260 D370
7339 D459
MEDIDAS
Øc. 16.00 mm
L. 93 mm
Øb. 16 mm



CHEVROLET CHEYENNE (92-97)
C30 (75-81), DODGE RAM 1500 (94-01)

HO102E

BALATAS
7136 D215
7385 D506
7554 D673
MEDIDAS
Øb. 16 mm
L. 70 mm

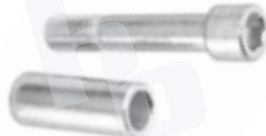

BUICK CENTURY (84-89), CHEVROLET
CAVALIER (96-04), PONTIAC SUNFIRE
(95-03)

HO103C

BALATAS
7X28 D333
7155 D233
7170 D265
7389 D510
7228 D333
MEDIDAS
Øc. 14 mm
L. 30 mm



CALIPER DOBLE PISTÓN
NP300 D22 (08-15) NISSAN
D22 (86-03), SENTRA (91-00),
TSUBAME (93-04), TSURU (84-
87), TSURU (87-91), TSURU
(88-91), TSURU (92-17)

HO103D

BALATAS
7155 D233
7389 D510
MEDIDAS
Øb. 8 mm
L. 66 mm



TUERCA GUIA
NISSAN SENTRA (91-00), TSUBAME
(93-04), TSURU (84-87), TSURU (87-91),
TSURU (88-91), TSURU (92-17)

HO103E

BALATAS
7X28 D333
7228 D333
MEDIDAS
Øb. 10 mm
L. 60 mm



TUERCA GUÍA CALIPER DOBLE PISTÓN
NP300 D21, D22 (08-15), TUERCA GUIA
NISSAN, FRONTIER (98-15) PICK-UP (86-
15), NISSAN URVAN (00-13)

HO103F

BALATAS
7170 D265
7171 D266
7282 D441
MEDIDAS
Øb. 12 mm
L. 58 mm



TUERCA GUIA NISSAN
D21 (86-03)

HO326

BALATAS
7532 D652
7558 D679
MEDIDAS
Øc. 12.70 mm
L. 25 mm



FORD EXPLORER (95-04)
LOBO (97-00), RANGER (95-04)

HO326A

BALATAS
7503 D626
7503 D632
MEDIDAS
Øc. 12.70 mm
L. 77 mm
Øb. 13.5 mm



FORD ECONOLINE
VAN E150 (92-01), F200 (86-91), F350

HO336

BALATAS
7097 D170
MEDIDAS
Øc. 10 mm
L. 61 mm
Øc. 12 mm

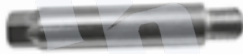

DODGE DART DELGADO (82-89)

HO340

BALATAS
7532 D652
7558 D679
MEDIDAS
Øb. 10 mm
L. 70 mm



TUERCA GUIA FORD EXPLORER,
LOBO (97-02), RANGER (95-02)

HO353

BALATAS
7164 D259
MEDIDAS
Øb. 13 mm
L. 63 mm



PLYMOUTH VOYAGER (84-90)
DODGE CARAVAN (84-90)

HO354

BALATAS
7259 D369
MEDIDAS
Øc. 9.52 mm
L. 69 mm
Øb. 1/2"



DODGE RAM
CHARGER (92-96)

Encuentra éstas y
miles de aplicaciones
más en:

hoautopartes.mx

RIELES PARA CALIPER



HO052HA

BALATAS
7054 D120



MUELLE FORD F350

HO052HB

BALATAS
7054 D120



RIEL FORD F350

HO165

BALATAS
7054 D120



ALAMBRE FORD F350

HOJ165H

BALATAS
7054 D120

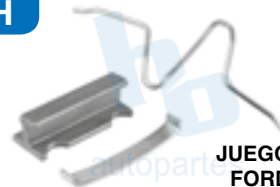

JUEGO DE HERRAJE
FORD F350 (73-93)

HO052H

BALATAS
7013 D50



MUELLE FORD F150 (76-98)

HO052HC

BALATAS
7013 D50

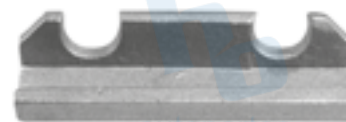

RIEL FORD F150

HOJ165HA

BALATAS
7013 D50



JUEGO DE HERRAJE FORD F150 (73-94)

HO051H

BALATAS
7027 D91



MUELLE FORD MAVERICK (70-77), V.A.M. AMERICAN
(73-80), GREMLIN (80-81), LERMA (80-82), RALLY (81-84)

HO051HA

BALATAS
7081 D149



MUELLE MICROBUS CHEVROLET C30 (75-81)

HO052HE

BALATAS
7081 D149



RIEL MICROBUS CHEVROLET C-30 (75-81)

HOJ052HE

BALATAS
7081 D149

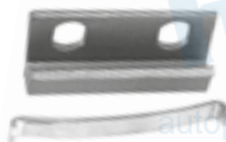

JUEGO DE HERRAJE
MICROBUS CHEVROLET
C-30 (75-81)

HO238

BALATAS
7013 D92
7054 D120
7013 D50
7125 D387
7125 D249
7330 D459



RIEL FORD
AEROSTAR,
F200 (86-91), F350 (87-93)
MICRO (VULCANIZADO)

HO052HF

BALATAS
7024 D89
7025 D129

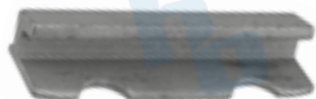

RIEL CHEVROLET C15 (82-88)

HO304

BALATAS
7299 D411



RIEL FORD MIDIBUS F450 (93-96), F-450 SUPER DUTY
(97-98) (VULCANIZADO)

HOJ102H

BALATAS
7136 D215
7192 D289



BUICK CENTURY,
CHEVROLET CAVALIER (94-96)
OLDSMOBILE CUTLASS (87-94)
(6 PIEZAS)

HOJ102HA

BALATAS
7339 D459



CHEVROLET CHEYENNE (88-02)
(6 PIEZAS), C30, C2500 (94-99),
C3500 (94-00), K1500 (92-97)

HO256A



BALATAS
795 D161
7046 D113
7059 D41
Ø. 6.00 mm
L. 73.00 mm

PERNO NISSAN 720 (80-86), DATSUN PICK UP (77-83)

HO256B



BALATAS
795 D161
7046 D113
7059 D41
Ø. 4.76 mm
L. 68.20 mm

PERNO NISSAN D21 (86-03)

HO256C



BALATAS
7353 D473
Ø. 6.30 mm
L. 87.31 mm

PERNO FORD ESCORT (91-02)

HO322



BALATAS
7503 D626

JUEGO DE BUJES
CHRYSLER SPIRIT (94-95), FORD F100 (77-83), F200 (86-91),
NISSAN ICHI VAN (88-94)

HO323



BALATAS
7X28 D333
7228 D333
7155 D275
7389 D510
7170 D265

JUEGO DE BUJES NISSAN, DATSUN PICK UP (89-92),
TSURU (84-87), TSURU (87-91), TSURU (92-17).

HO357



BALATAS
7X83 D280
Ø. 6.30 mm
L. 74 mm

PERNO VW JETTA CON PERFORACION (87-92)

HO500



BALATAS
7072B D181
L. 41 mm

BUJE CORTO FORD MUSTANG (82-93)

HO500A



BALATAS
7072 D152
L. 55 mm

BUJE LARGO MUSTANG (82-93)

HO500B



BALATAS
7087 D158
71X5 F013
7168 D158
7183 D280
7569 D694
7106 D257
L. 40 mm

BUJE DODGE DART (84-02), FORD TOPAZ (84-94), VW JETTA (84-02)

HO500C



BALATAS
7087 D158
7168 D158
71X5 F013
7183 D280
7569 D694
L. 50 mm

BUJE CHEVROLET CELEBRITY (82-90), VW CORSAR (84-88)

HO500E



BALATAS
7072 D152
L. 44 mm

BUJE MEDIANO FORD (79-92)

Encuentra éstas y miles de aplicaciones más en:

hoautopartes.mx

*Ø. = DIÁMETRO EXTERIOR

*h. = ALTURA

*CE.= CÓDIGO EQUIVALENTE

* TODOS LOS PISTONES INCLUYEN LIGA Y SILICÓN

JUEGOS DE HERRAJES PARA CALIPER



HO234 **HO088H** **HOJ088H**
 MEDIDAS L. 75 mm

PERNO PARA CALIPER VW COMBI (73-02) BALATA 7021 D45
SEGURO CALIPER VW COMBI (73-02) BALATA 7021 D45
JUEGO DE HERRAJE VW COMBI (73-01) (4 PIEZAS)

HO233 **HO089H** **HOJ089H**
 MEDIDAS L. 69 mm

PERNO PARA CALIPER VW CARIBE (77-87) BALATA 7031 D96
SEGURO CALIPER VW CARIBE (77-87) BALATA 7031 D96
JUEGO DE HERRAJE VW CARIBE (77-87) (4 PIEZAS)

HO103B **HO103A** **HOJ103H**
 L. 41 mm L. 60 mm

TORNILLO DATSUN PICK UP (75-84) (CORTO) BALATA 780 D37
TORNILLO DATSUN PICK UP (75-84) (LARGO) BALATA 780 D37
JUEGO DE HERRAJES DATSUN (72-86) NISSAN PICK UP (84-89) (2 PIEZAS)

HOJ102HB
 BALATAS 7259 D369 7259 D368 7260 D370

JUEGO DE BUJES PARA CALIPER BUICK CENTURY (92-97), CHEVROLET CHEYENNE C2500 (92-97), C3500 (94-00), DODGE RAM 1500 (90-97)

HOJ166H
 BALATAS 7807 D224 7809 D236 7149 D236

JUEGO DE RIELES CHEVROLET C-65 (84-00), KODIAK (97-00), FORD F600 (84-00), GMC C6000 (84-00), C6500 TOPKICK (97-00)

HOJ183H
 BALATAS 7072B D181

JUEGO DE HERRAJE FORD FAIRMONT (78-83) MUSTANG (82-93) (CORTO) 4 PIEZAS

HOJ183HA
 BALATAS 7072 D152

JUEGO DE HERRAJE FORD FAIRMONT (78-83) MUSTANG (82-93) (LARGO) 4 PIEZAS

HOJ184H
 BALATAS 728 D52 7214 D52

JUEGO DE HERRAJE CHEVROLET C10 (75-86), C15 (75-87) (14 PIEZAS)

HOJ184HA
 BALATAS 7070 D202 7070 D154 7480 D202

JUEGO DE HERRAJE BLAZER (72-74), CAPRICE (79-99), CENTURY (78-81), K5 BLAZER (79-86), MALIBU (97-99), REGAL (78-91) RIVIERA (79-81), S10 (83-99) (14 PIEZAS)

HOJ186H
 BALATAS 7072 D310

JUEGO DE HERRAJE FORD THUNDERBIRD (89-92) MERCURY COUGAR (89-92) (4 PIEZAS)

HO020H **HO185**

PLACA DE FRENO DE DISCO DODGE D300 (75-80)
SEGURO PARA RUEDA DODGE D150 (77-89)

HOJ185H
 BALATAS 7017 D84

JUEGO DE HERRAJE DODGE D100 (75-85), D150 (77-93), D300 (75-80), D350 (81-93), DART (74-82), PLYMOUTH DUSTER (74-76) (8 PIEZAS)

* TODOS LOS PISTONES INCLUYEN LIGA Y SILICÓN

*Ø. = DIÁMETRO EXTERIOR
 *h. = ALTURA
 *CE. = CÓDIGO EQUIVALENTE

HO020HB

BALATAS
7470 D591
7518A D642



CHRYSLER CIRRUS (95-00), CONCORDE,
VOYAGER (93-00), DODGE INTREPID (93-
00), STRATUS (95-00)

HO182H

BALATAS
7097 D170



CHRYSLER DART K (82-89)

HO183A

BALATAS
BLANCO
7125 D249
7125 D387



CHEVROLET MICRO, FORD
F-250 (73-85)

HO183

BALATAS
NEGRO
7013 D50
7027 D91



CHEVROLET MICRO, FORD F-250 (73-85)

HO184

BALATAS
728 D52
7214 D52



CHEVROLET NOVA AUTO y PICK-UP
(73-83)

HO184A

BALATAS
7070 D154
7070 D159



CHEVROLET MALIBU (97-99), REGAL
(78-91)

HO184B

BALATAS
7403A D521
7404A D522



DODGE SPIRIT (89-95)

HO184C

BALATAS
7136 D215
7192 D289



CHEVROLET CAVALIER (91-92), CELEBRITY
(82-90), OLDSMOBILE CUTLASS (87-94)

HO186A

BALATAS
7082A D150
7082E D346



MERCURY GRAND MARQUIS (81-93)

HO186B

BALATAS
7X82 F063
7082A D150
7378 D499



MERCURY GRAND MARQUIS (90-94)

HO240

BALATAS
7X83 D569
72X9 D569
7031 D96
7183 D280
7209 D280



JUEGO SEGUROS PARA VW ATLANTIC
(84-97), CARIBE, GOLF (87-94), JETTA
(77-92)

HO240A

BALATAS
7031 D96



VW ATLANTIC (84-97), CARIBE,
CORSAR (84-88)

HO240B

BALATAS
7403 D521
7404 D522
7406 D524



CHRYSLER SHADOW (89-94), SPIRIT
(90-95), DODGE CARAVAN (90-
96), PLYMOUTH VOYAGER (90-96),
CHRYSLER GRAND VOYAGER (90-96)

HO241A

BALATAS
795 D161
7795 D57
7047 D114



NISSAN 720 (81-83), GRANDE

HO241B

BALATAS
7155 D233



NISSAN TSURU (84-87),
TSURU (87-91)

HO241C

BALATAS
7170 D265
7171 D266
7282 D441



NISSAN ICHI VAN, PICK-UP (88-94)

HO241D

CHICO
BALATAS
7046 D113
795 D161
7100 D173
7150 D246



PORTA SEGURO PARA NISSAN 720
(81-83)

HO241E

GRANDE
BALATAS
7046 D113
795 D161
7100 D173
7150 D246



PORTA SEGURO PARA NISSAN 720
(81-83)

SEGUROS PARA CALIPER



HO245 BALATAS 7106 D257

FORD TOPAZ (82-94)

HO300 BALATAS 7535 D655

FORD F350 (R) (95-00)

HO300A BALATAS 7535 D655

FORD F350 (L) (95-00)

HO302 BALATAS 7X28 D333 7228 D333

NISSAN NP300, D22, NISSAN PICK UP (95-08), FRONTIER (98-04)

HO304A BALATAS 7299 D411

FORD F-450 SUPER DUTY (97-98), MIDIBUS F450 (88-98)

HO305 BALATAS 7384 D623 7454 D673

CHEVROLET CAVALIER (92-95), PONTIAC SUNFIRE (92-95)

HO307 BALATAS 7134 D220

DODGE DART (83-84)

HO314A BALATAS 7219 D466 7353 D473 7219 D466 7353 D473

FORD ESCORT (91-02)

HO314B BALATAS 7338 D458 7515 D636 7682 D663 7514 D663

FORD ESCORT (91-02) RUEDA TRASERA

HO312 BALATAS 7389 D510

NISSAN TSURU (92-17) DISCO VENTILADO

HO312A BALATAS 7389 D510

NISSAN TSURU (92-17) DISCO SÓLIDO

HO314 BALATAS 7219 D466 7353 D473

FORD ESCORT (91-98), MAZDA MX3 (92-96), 323 (86-94), PROTEGE (90-97)

HO315 BALATAS 7X5 F030 755 D21

VW SEDAN (95-03)

HO324 BALATAS 7133 D219

JUEGO DE SEGUROS CHRYSLER SPIRIT (89-94), LEBARON (77-95), SHADOW USA (89-94)

HO324A BALATAS 7164 D259

JUEGO DE SEGUROS CHRYSLER SHADOW (89-94), VOYAGER (84-96), DODGE CARAVAN (84-96)

HO325 BALATAS 7503 D626 7503 D632

FORD CHATEAU VAN (94-96), CLUB WAGON (95-98), FORD E-150 ECONOLINE (94-96), F100 (77-83), F200 (86-91), F350 (94-96), TRITON V8 (94-96)

HO327 BALATAS 7155 D275

NISSAN TSURU (84-87), TSURU (87-91)

HO328 BALATAS 7146 D272

NISSAN 200SX (88-99) RUEDA TRASERA

* TODOS LOS PISTONES INCLUYEN LIGA Y SILICÓN

*Ø. = DIÁMETRO EXTERIOR
*h. = ALTURA
*CE. = CÓDIGO EQUIVALENTE

HO335

BALATAS
7170 D265



NISSAN ICHI-VAN (88-94) JAPONÉS

HO337

BALATAS
7528 D648
D745



FORD CONTOUR (95-00), MERCURY MYSTIQUE (95-00)

HO338

BALATAS
7532 D652
7558 D679



SEGURO TENSOR F.D. FORD EXPLORER (95-04), LOBO (97-02) RANGER (95-04)

HO339

BALATAS
7532 D652
7558 D679



SEGURO F.D. PARA FORD EXPLORER (95-04), LOBO (97-02), RANGER (95-04)

HO350

BALATAS
7511 D633



DODGE NEON (95-07)

HO365

BALATAS
7511 D633



FORD NEON (95-97)

HO366

BALATAS
7530 D650



CHRYSLER CIRRUS (96-00), CONCORDE (95-00), DODGE STRATUS (95-00)

HO369

BALATAS
7528 D648



FORD CONTOUR 95-01, MERCURY MYSTIQUE (95-01)

HO371



SEGURO PARA CALIPER TRACTOCAMION UNIVERSAL

HO372

BALATAS
72X1 F038
72X2 D688
7563 D688



CHEVROLET CHEVY (96-12), MONZA (03)

HO373

BALATAS
7133 D219
7164 D259



CHRYSLER SHADOW, SPIRIT, SHADOW USA (89-94), VOYAGER, DODGE CARAVAN (84-95)

HO374

BALATAS
7133 D219
7139 D221
7164 D259



CHRYSLER VOYAGER (84-92), DODGE CARAVAN (84-95), CHRYSLER SHADOW (89-94)

HO382

BALATAS
7635 D768
7709 D768



VW BEETLE (99-05), GOLF A4 (05-07), JETTA EXTERNO (97-02)

HO381

BALATAS
7635 D768
7709 D768



VOLKSWAGEN BEETLE (97-02), JETTA (97-02), GOLF A4 97-02, AUDI A3 (01-09)

HO409

BALATAS
7690 D816
7690 D816



FORD FOCUS (00-03)

HO825

BALATAS
7X59 F015
7394 D516



PEUGEOT 206 (00-07), 306 (00-02) RUEDA TRASERA

HO827

BALATAS
7628 D760



SENSOR PARA BALATA DE FRENO DE DISCO MERCEDES BENZ ML320, ML430 (98-03), ML350 (98-05)

Encuentra éstas y miles de aplicaciones más en:

hoautopartes.mx

JUEGO DE SEGUROS PARA CALIPER



HO102J

BALATAS
7335 D340
7234 D340



JUEGO DE SEGUROS PARA CALIPER
RUEDA TRASERA CON FRENO DE DISCO,
VW BEETLE (99-05), JETTA A4 (99-00), GL,
GLS y GLX -(99-00), PASSAT (99-00)

HO106JS

BALATAS
7Y08 F221
8555 D1437



JUEGO DE SEGUROS PARA CALIPER
RUEDA DELANTERA VW POLO (03-07)
SEAT CORDOBA, IBIZA (03-09)

HO205J

BALATAS
7726 D850
7652 D784



JUEGOS DE SEGUROS PARA CALIPER
RUEDA DELANTERA CADILLAC SEVILLE (98-
02), CHEVROLET SILVERADO 1500 (00-01),
2500 (00-01), SUBURBAN 2500 (00-01), GMC
SIERRA, YUKON XL 2500 (00-01)

HO206J

BALATAS
7653 D785



JUEGO DE SEGUROS PARA CALIPER
RUEDA TRASERA
CHEVROLET SILVERADO 1500 (00-03), 2500 (99-03), (09-
11) SUBURBAN 2500 (00-03), GMC SIERRA, YUKON XL
2500 (00-03), RUEDA DELANTERA CADILLAC ESCALADE
(02-03), CHEVROLET AVALANCHE 1500 (02-04), C-30 (75-
81), SILVERADO 1500 (03), TAHOE (99-03), GMC YUKON
XL 1500 (00-03), EXPRESS 1500 (03-08)

HO225J

BALATAS
778X F202
8742 D1617



JUEGO DE SEGUROS RUEDA
TRASERA CHEVROLET ZAFIRA
COMFORT (02-06) MERIVA (07-08)
CHEVROLET ASTRA (00-08)

HO231J

BALATAS
07788 D909



JUEGO DE SEGUROS PARA
CALIPER RUEDA TRASERA
CHEVROLET SILVERADO 2500
(04-05), SILVERADO 3500 (01-04)

HO233J

JUEGO DE SEGUROS PARA
CALIPER RUEDA DELANTERA
CHEVROLET CORSA,
TORNADO (02-05), CHRYSLER
GRAND VOYAGER RIN 15"
(01-02), DODGE CARAVAN RIN
15" (01-02), JEEP LIBERTY
(02), FORD FREESTAR (04-
05), RUEDA TRASERA FORD
FREESTAR (04-05)



HO240J

BALATAS
74X7 F139
8433 D1321



JUEGO DE SEGUROS PARA CALIPER
PONTIAC MATIZ (04-10), CHEVROLET
MATIZ (11-15), SPARK (11-15), DAEWOO
NUBIRA (99-02), RUEDA DELANTERA

HO300J

BALATAS
7535 D655



JUEGO DE SEGUROS PARA
CALIPER RUEDA DELANTERA
FORD F-350 (95-00)

HO313J

BALATAS
7625 D756
7625 D824



JUEGO DE SEGUROS PARA CALIPER
RUEDA DELANTERA FORD F-250, F-350
(98-04), F-350 SUPER DUTY (19-00)

HO316J

BALATAS
7674 D803



JUEGO DE SEGUROS PARA CALIPER
RUEDA DELANTERA FORD WINDSTAR
(99-03)

HO320J

BALATAS
7644 D777

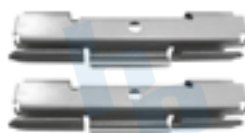

JUEGO DE SEGUROS PARA CALIPER
RUEDA DELANTERA Y TRASERA
FORD F350 SUPER DUTY (99-06), FORD
F550 SUPER DUTY (99-01), FORD
TRITON (99-06)

HO338J

BALATAS
7948 D1045



JUEGO DE SEGUROS PARA CALIPER
RUEDA DELANTERA FORD ECONOLINE
E-150 (99-02), E-250 (04-06)

*Ø. = DIÁMETRO EXTERIOR

*h. = ALTURA

*CE. = CÓDIGO EQUIVALENTE

* TODOS LOS PISTONES INCLUYEN LIGA Y SILICÓN

FRENOS HO 2024-2025

65

HO399J

BALATAS
7986 D1081
D1327



JUEGO DE SEGUROS PARA FRENO DE DISCO FORD MUSTANG V6 (05-09), VW ROUTAN (09-13)

HO401J

JUEGO DE SEGUROS PARA CALIPER, RUEDA DELANTERA CHRYSLER INTREPID (98-00), CIRRUS (95-98), CIRRUS (95-00), LE BARON (77-95), NEW YORKER, SHADOW (89-94), SPIRIT (90-93), VOYAGER (96-99), DODGE CARAVAN (96-99) y (94-96), NEON (95-04) RIN 14", STRATUS (95-98) y (95-00), JEEP GRAND CHEROKEE (97-98) y (99-02).



BALATAS
7438 D641
7530 D650
7403 D521
7303 D512
7518 D730
7404 D522
7660 D790
7502 D713
7470 D591
7358 D477

HO411J

BALATAS
7718 D842
7576 D702
7694 D821
7576 D702
7627 D758



JUEGO DE SEGUROS PARA CALIPER RUEDA DELANTERA DODGE RAM 1500 (00-02), RAM 2500, 3500 (98-02), FORD EXPEDITION (97-02), FORD LOBO F250 (99-00), LINCOLN NAVIGATOR (98-00)

HO414J

BALATAS
7694 D859



JUEGO DE SEGUROS PARA CALIPER RUEDA DELANTERA DODGE RAM 2500, 3500 (02-03)

HO503J

BALATAS
7546 D668



JUEGO DE SEGUROS PARA CALIPER RUEDA DELANTERA NISSAN LUCINO GSR (99-00), SENTRA GSX (96-00), 200SX (95-98)

HO507J

BALATAS
71X4 F05
8256 D1146



JUEGO DE SEGUROS PARA CALIPER, RUEDA DELANTERA RENAULT CLIO (02-10)

HO512J

BALATAS
7390 D511
8256 D114



JUEGO DE SEGUROS PARA CALIPER RUEDA TRASERA NISSAN TSURU GSR (93-96)

HO513J

BALATAS
7342 D485



JUEGO DE SEGUROS PARA CALIPER RUEDA DELANTERA NISSAN SENTRA (01-04) 240SX (91-98)

HO518J

BALATAS
7468 D588
7566 D691



JUEGOS DE SEGUROS PARA CALIPER RUEDA DELANTERA NISSAN XTRAIL (03-04)

HO519J

BALATAS
7784 D-905



JUEGO DE SEGUROS PARA CALIPER RUEDA TRASERA NISSAN XTRAIL, MURANO (03-04)

HO520J

BALATAS
772X D191
8257 D1147



JUEGOS DE SEGUROS PARA CALIPER, RUEDA DELANTERA NISSAN ALMERA (01-07)

HO528J

BALATAS
8456 D1345
7Y93 F302



JUEGO DE SEGUROS PARA CALIPER RUEDA DELANTERA NISSAN TIIDA (07-18)

HO600J

BALATAS
7153 D242
7247 D356



JUEGO DE SEGUROS PARA CALIPER RUEDA DELANTERA, TOYOTA CAMRY (83-91), COROLLA (88-96), TERCEL (86-90)

HO601J

BALATAS
7220 D320
7454 D574



JUEGO DE SEGUROS PARA CALIPER RUEDA DELANTERA, MAZDA PICK-UP B-1800 (77-78), 2000 (79-87), 2200, 2600 (87-03), 2300 (94-10), 3000, 4000 (94-04), MAZDA PICK-UP 2200 (90-99), 2WD (90-93)

JUEGO DE SEGUROS PARA CALIPER



HO602J

BALATAS
7127 D207
7320 D589



JUEGO DE SEGUROS PARA CALIPER RUEDA DELANTERA
TOYOTA CRESSIDA (81-98), CRESSIDA WAGON (83-87), PICK-UP (81-95),
LAND CRUISER (92-97), GREATWALL HAVAL H3 (05-10), HAVAL H5 (05-10)

HO604CJ

BALATAS
7Y35 F278
8729 D1520



JUEGO DE SEGUROS PARA CALIPER RUEDA DELANTERA,
DODGE H100 (06-09)

HO604J

BALATAS
7X37 F138
8258 D1148



JUEGO DE SEGUROS PARA CALIPER RUEDA DELANTERA
DODGE ATOS (01-12)

HO604BJ

BALATAS
7Y02 F208
8253 D1142



JUEGO DE SEGUROS PARA CALIPER RUEDA DELANTERA,
DODGE ATOS (01-12), DISCO VENTILADO

HO620J

BALATAS
7320 D589
7127 D207



JUEGO DE SEGUROS PARA CALIPER RUEDA DELANTERA,
TOYOTA LONG BED, XTRA CAB (92-93), PICK-UP (81-95)

HO633AJ

BALATAS
78X3M F065
8759 D1550



JUEGO DE SEGUROS PARA CALIPER RUEDA DELANTERA,
TOYOTA COASTER (95-03) 2 RUEDAS

HO641J

BALATAS
8301 D1184
8330 D1210
8331 D211



JUEGO DE SEGUROS PARA CALIPER RUEDA DELANTERA,
TOYOTA YARIS (05-07), TOYOTA RAV4 (06-18)

HO807J

BALATAS
7Y01 F207
8255 D1145



JUEGO DE SEGUROS PARA CALIPER RUEDA DELANTERA,
RENAULT MEGANE (01-03), SCENIC (01-04), CLIO SPORT (02-10)

Encuentra éstas y miles de
aplicaciones más en:

hoautopartes.mx

*Ø. = DIÁMETRO EXTERIOR

*h. = ALTURA

*CE. = CÓDIGO EQUIVALENTE

* TODOS LOS PISTONES INCLUYEN LIGA Y SILICÓN

FRENOS HO 2024-2025

67

HO010HA

BALATAS
2168 538
2089 445



LEVA CHRYSLER VOYAGER (84-02)
DODGE CARAVAN (84-02), DAKOTA
(87-99) D100 (75-85)

HO010HB

BALATAS
2137 314
2171 583



JUEGO DE LEVAS PARA FRENO R Y L
FORD F350 (73-96) (2 PIEZAS)

HO011H

BALATAS
2131
2137 314



LEVA FORD F150 (76-98) Y F350 (68-98)

HO011HA

BALATAS
2182T 734
2182T S723



JUEGO DE LEVAS PARA ZAPATA R Y L
DODGE RAM 1500 (99-00) FORD
ECONOLINE VAN E150, LOBO (99-00),
RANGER (95-02) (2 PIEZAS)

HO149

BALATAS
1433 S638



JUEGO DE ANCLAS PARA ZAPATA R Y L
NISSAN TSURU (92-17) (2 PIEZAS)

HO149A

BALATAS
1394 S636
1496 S720



JUEGO DE ANCLAS PARA ZAPATA R Y L
CHEVROLET MALIBU (97-00) OLDSMOBILE
CUTLASS (97-99) (2 PIEZAS)

HO149B

BALATAS
1373 532



ANCLA PARA ZAPATA R NISSAN TSURU
(87-91)

HO149C

BALATAS
1373 532



ANCLA PARA ZAPATA L NISSAN TSURU
(87-91)

HO150

BALATAS
1444 S657



JUEGO DE ANCLAS PARA ZAPATA CHRYSLER
LEBARON (77-95), NEWYORKER (90-96),
SHADOW (89-94), INTREPID (93-96), DODGE
SPIRIT (90-95) (2 PIEZAS)

HO151

BALATAS
2012AT 151



ANCLA UÑA R DODGE, FORD MUSTANG
II (74-78), CHEVROLET (58-67)

HO152

BALATAS
2012AT 151



ANCLA UÑA L DODGE, FORD MUSTANG
II (74-78), CHEVROLET (58-67)

HO153

BALATAS
2012AT 151
2161TT 263
2081TT 264
2151TT 474
2151T 569
2089A 581
2141A 582
155



ANCLA OJO R FORD F150 (67-96)

HO154

BALATAS
2012AT 151
2161TT 263
2081TT 264
2151TT 474
2151T 569
2089A 581
2141A 582
155

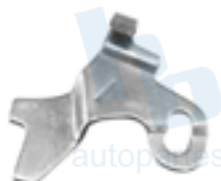

ANCLA OJO R FORD F150 (77-93)

HO166R

BALATAS
1350 501



ANCLA PARA ZAPATA FORD TOPAZ
(84-94) GHIA (91-93) TEMPO (84-90) (R)

HO166L

BALATAS
1350 501



ANCLA PARA ZAPATA FORD TOPAZ
(84-94) GHIA (91-93) TEMPO (84-90) (R)

HO166AR

BALATAS
1395 566



ANCLA FORD TAURUS (R) (87-94)

HO166AL

BALATAS
1395 566



ANCLA FORD TAURUS (R) (87-94)

HO310

BALATAS
2165T 552



JUEGO DE ANCLAS PARA ZAPATA CHEVROLET
CAVALIER (92-94), CELEBRITY (92-90),
OLDSMOBILE CUTLASS (87-94) (2 PIEZAS)

ANCLAS Y LEVAS PARA ZAPATA



HO310A BALATAS
2164 553

JUEGO DE ANCLAS PARA ZAPATA CHEVROLET CAVALIER (95-98) (2 PIEZAS)

HO351L BALATAS
1399 574
1433 S631

ANCLA PARA ZAPATA L NISSAN PICK UP (95-08), FRONTIER (98-04)

HO351R BALATAS
1399 574
1433 S631

ANCLA PARA ZAPATA R NISSAN PICK UP (95-08), FRONTIER (98-04)

HOJ015H BALATAS
1396 S618
1452 S655

JUEGO DE ANCLAS PARA FRENO R Y L FORD THUNDERBIRD (89-92), WINDSTAR (95-98), MERCURY COUGAR (89-92), NISSAN QUEST (93-02), (2 PIEZAS)

HOJ080H BALATAS
1404 593
1404A S675

JUEGO DE ANCLAS PARA FRENO R y L CHEVROLET C1500 (91-99), BLAZER (94-98), TAHOE (95-00), SILVERADO (95-98), GMC SIERRA, YUKON (94-98)

HOJ090H BALATAS
1366 520
415
759

JUEGO DE ANCLAS PARA FRENO R Y L DODGE DART (83-89), SHADOW, SPIRIT (89-94), DODGE STRATUS (95-00) (2 PIEZAS)

HOJ090HA BALATAS
1473 S689
698

JUEGO DE LEVAS PARA FRENO R Y L DODGE NEON (95-05) (2 PIEZAS)

HOJ090HB BALATAS
1485A S714
1485 S703

JUEGO DE ANCLAS PARA FRENO R y L CHRYSLER TOWN & COUNTRY (97-01), GRAND VOYAGER (01-02), PLYMOUTH VOYAGER (98-01) (2 PIEZAS)

HOJ149H BALATAS
1373 532

JUEGO DE LEVAS PARA ZAPATA R Y L NISSAN TSURU (95-08) (2 PIEZAS)

HOJ150H BALATAS
1399 574

JUEGO DE LEVAS PARA ZAPATA R y L PARA FRENO NISSAN PICK-UP (91-01) (2 PIEZAS)

HOJ165JH BALATAS
2117B S651
2117A 514
2117A 242

JUEGO DE ANCLAS PARA FRENO R y L CHEVROLET ASTRO (85-02), S10 BLAZER (83-94), EL CAMINO (75-87), (2 PIEZAS)

HOJ408H BALATAS
13X0 FT003
994 1665
427

JUEGO DE ANCLAS PARA FRENO R Y L CHEVROLET CHEVY MONZA (03), CORSA (02-08) (2 PIEZAS)

HOJ413H BALATAS
1379 S707

JUEGO DE ANCLAS PARA FRENO R Y L DODGE ATOS (01-12) (2 PIEZAS)

HOJ419H BALATAS
1344 565

JUEGO DE ANCLAS PARA FRENO R y L MAZDA PICK-UP (86-93), 4X2 (89-96), B1800 (77-78), B2000 (79-87), B2300 (94-10), B2600 (87-03), B3000, B4000 (94-04) (2 PIEZAS)

HOJ433H BALATAS
2156 523
1358 505

JUEGO DE ANCLAS PARA FRENO, R y L TOYOTA PICK UP (84-94) (2 PIEZAS)

HOJ437H BALATAS
8428 951
2X64 FT001

JUEGO DE ANCLAS PARA FRENO R Y L CHEVROLET CHEVY PICK UP (99-03) (2 PIEZAS)

HOJ461H BALATAS
2X60

JUEGO DE LEVAS PARA FRENO TOYOTA COASTER (95-03)

Encuentra éstas y miles de aplicaciones más en:
hoautopartes.mx

* TODOS LOS PISTONES INCLUYEN LIGA Y SILICÓN

*Ø. = DIÁMETRO EXTERIOR
*h. = ALTURA
*CE. = CÓDIGO EQUIVALENTE

HO117



SEGUROS TIPO "E" PARA
ZAPATA DE 9.52 mm
UNIVERSAL

HO117A



SEGUROS TIPO "E" PARA
ZAPATA DE 7.95 mm
UNIVERSAL

HO117B



SEGUROS TIPO "E" PARA
ZAPATA DE 6.35 mm
UNIVERSAL

HO117C



SEGUROS TIPO "E" PARA
ZAPATA DE 4.76 mm
UNIVERSAL

HO117D



SEGUROS TIPO "E" PARA
ZAPATA DE 3.17 mm
UNIVERSAL

HO117E



SEGUROS TIPO "E" PARA
ZAPATA DE 5.55 mm
UNIVERSAL

HO253

BALATAS
2137 314

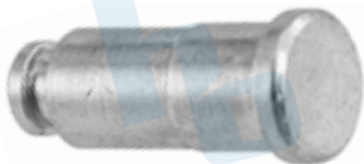

FORD F350 (68-98)

HO253A

BALATAS
315



VW 1500, 1600 (73-94),
SEDAN (72-83)

HO253B

BALATAS
2168 538
2089 445



PLYMOUTH VOYAGER,
DODGE CARAVAN (84-95)

HO253C

BALATAS
1438 S638

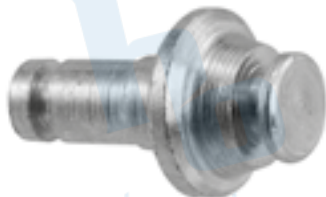

CONICO NISSAN TSURU (92-17)

HO253D

BALATAS
1438 S638

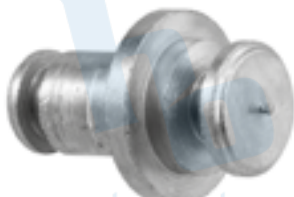

PLANO NISSAN TSURU (92-17)

HO253E

BALATAS
2165T 552
2164 553



CHEVROLET CAVALIER (90-95)

HO253F

BALATAS
1350-501



FORD TOPAZ (84-94)

HO253G

BALATAS
2182T S723



FORD LOBO (98-00)

HO253H

BALATAS
1396 S618
1452 S665



FORD WINDSTAR (95-98), MERCURY
COUGAR (89-92), NISSAN QUEST (93-02)

PERNOS Y PARTES PARA ZAPATA



HO253J

BALATAS
1364-576
1379-639
1429-627



HONDA ACCORD (90-00), CIVIC (92-00)

HO253K

BALATAS
1344 565



MAZDA PICK UP B2000 (79-87),
B2200 (87-93), B2300 (94-10), B2600
(87-03), B3000 (94-04)

HO253L

BALATAS
1404 593



CHEVROLET SILVERADO (95-00)

HO275

BALATAS
2106T 228
2006 280
2117 242
2157 S656
2042 S655
242



CASQUILLO PARA ZAPATA
CHEVROLET C1500 (91-99), C2500 (88-00),
C3500 (94-00), C10 SUBURBAN (75-78), C20
SUBURBAN (79-99), DODGE RAM (71-94)

HO275A

BALATAS
2164 553



CASQUILLO PARA ZAPATA
CHEVROLET CAVALIER (90-98),
PONTIAC GRAND AM (90-98)

HO275B

BALATAS
2117 2142
2165T 552
2117 514



CASQUILLO PARA ZAPATA CHEVROLET
CAVALIER, (90-95), MALIBU (79-81), ASTRO (90-92),
S10 (82-03), S15 (82-90), GMC SONOMA (95-03),
SAFARI (90-92)

HO306

BALATAS
1373 532



SUJETADOR PARA ZAPATA
NISSAN TSURU (84-87), TSURU (87-91)

HO306A

BALATAS
1373 532



SEGURO SUJETADOR DE ZAPATA
NISSAN TSURU (84-87), TSURU (87-91)

HO306B

BALATAS
1487 S636
1496 S720



SEGURO SUJETADOR DE ZAPATA
CHEVROLET MALIBU (97-00),
OLDSMOBILE CUTLASS (87-94)

HO306C

BALATAS
1439 S642



SEGURO HERRADURA PARA ZAPATA
TOYOTA TERCEL L40 (90-94) L50 (95-00)

HO330

BALATAS
8080 421
8080 197
8080 503



SEGURO PARA SEPARADOR DE
ZAPATA VW COMBI (74-98)

HO330A

BALATAS
882A 315



SEGURO PARA SEPARADOR DE
ZAPATA VW SEDAN (74-92)

HO362

BALATAS
264 2080



PERNO FORD F100 (77-83),
F150 (76-93)

HO363A

BALATAS
1404 593
1404A S675



PERNO CHEVROLET C15 (82-88)

Encuentra éstas
y miles de
aplicaciones
más en:

hoautopartes.mx

HO331 SEPARADOR DE ZAPATA FORD F150 (80-94) R y L	BALATAS 2080 264	HO332 SEPARADOR DE ZAPATA FORD F150 (80-94) R y L	BALATAS 2080 264	HO344 NISSAN PICK UP (91-15) NISSAN D21 (86-03), D22 (91-15), FRONTIER (98-15), NP 300	BALATAS 1399 574
HO452AR TOYOTA PICK UP (81-95)	BALATAS 2156 523	HO452AL TOYOTA PICK UP (81-95)	BALATAS 2156 523	HO439R VW POINTER R Y L (01-03) VAGONETA	BALATAS 1353 495
HO439L VW POINTER R Y L (01-03) VAGONETA	BALATAS 1353 495	HO446R SEAT CORDOBA (03-09) CROSSFOX (07-13) LUPO (05-09) VW CABRIOLET (85-93) GOLF, JETTA (93-99) R	BALATAS 1450 662	HO446L SEAT CORDOBA (03-09) CROSSFOX (07-13) LUPO (05-09) VW CABRIOLET (85-93) GOLF, JETTA (93-99) L	BALATAS 1450 662
HO447R VW ATLANTIC (84-97), CARIBE (77-87), GOLF, JETTA (87-92), POINTER (99-03) R	BALATAS 1354 559	HO447L VW ATLANTIC (84-97), CARIBE (77-87), GOLF, JETTA (87-92), POINTER (99-03) L	BALATAS 1354 559	HO448 CHRYSLER GRAND VOYAGER (95-99), MINI VAN, PLYMOUTH VOYAGER (88-95), DODGE CARAVAN (84-95), DAKOTA (87-97) FORD RANGER (98-00) R Y L	BALATAS 2168 538
HO449 FORD RANGER XLT (88-91) R y L	BALATAS 2151 569 2151 474	HO450 CHEVROLET CAPRICE, CAVALIER (85-92) IMPALA (83-85), MALIBU (79-93), PONTIAC GRAND AM (90-98) MONTECARLO (72-74) R Y L	BALATAS 2165T 552 2164 553	HO450A SEPARADOR PARA BALATA CHEVROLET S10, S15 (85-89) S10 BLAZER (83-94), GMC JIMMY (85-02), SONOMA (91-03)	BALATAS 2117 242 2117 514
HO451 AMERICAN MOTORS AMERICAN (62-68), RAMBLER (69), V.A.M. AMERICAN (73-80), GREMLIN (62-85), JAVELIN (68-73), DODGE D100 (75-85), D150 (77-93), DART (65-81), FORD FALCON (60-70), MUSTANG (82-93), CHRYSLER LEBARON (77-95), PLYMOUTH VALIANT (75-83), VOLARE (76-80)	BALATAS 2012AT 155 2089A 155 151 581	HO452 CHEVROLET C10 (75-86), C20, C20 SUBURBAN (76-86), C30 (75-81), C35 (94-00), EXPRESS 1500 (97-02), CHEVROLET K20 (76-85), SUBURBAN 1500 (97-02), GMC K35 (76-92), P3500 (79-83)	BALATAS 2042 S655 2157 S656	HO604 VW SEDAN (74-92)	BALATAS 882A 315
HO118AR PALANCA AJUSTABLE PARA FRENO CHEVROLET C15 (82-88), C1500 SUBURBAN (92-99), CHEYENNE(85-90), K1500 (98-90)	BALATAS 2073 473 2073A 653	HO118AL PALANCA AJUSTABLE PARA FRENO CHEVROLET C15 (82-88), C1500 SUBURBAN (92-99), CHEYENNE(85-90), K1500 (98-90)	BALATAS 2073 473 2073A 653	HO165A JUEGO DE ESLABON CHEVROLET C30 (75-81), (2 PIEZAS)	BALATAS 2042 S655 2157 S656
HO165B JUEGO DE ESLABON (2 PIEZAS) CHEVROLET C10 (75-86) C1500 (91-99), C1500 SUBURBAN (92-99), C2500 (88-00)	BALATAS 228 2073T 473	HO438L JUEGO DE LEVA PARA FRENO DE MANO FORD F350 L (96-08)	BALATAS 2137 314 2171 583	HO438R JUEGO DE LEVA PARA FRENO DE MANO FORD F350 R (96-08)	BALATAS 2137 314 2171 583

PARTES PARA TAMBOR



HO059



SEGURO PARA FRENO H-1
INTERNATIONAL DINA
UNIVERSAL

HO060



SEGURO PARA FRENO H3
UNIVERSAL

HO061



SEGURO PARA FRENO
H2 NISSAN TSURU (84-87),
TSURU (88-91), TSURU (92-17)

HO062



SEGURO PARA FRENO H4
DODGE C10 CAMIONETA (75-86)

HO174



SEGURO DE HELICE BALATA TRASERA
CHEVROLET C15 (82-87), C1500 SUBUR-
BAN (92-99), FORD F150 (76-90)

HO235



ESTRELLA PARA AJUSTE DE
FRENO

HO352R

BALATAS
882A 315



LEVA FRENO DE MANO VW
SEDAN (74-92)

HO352L

BALATAS
882A 315



LEVA FRENO DE MANO VW
SEDAN (74-92)

HO364

BALATAS
716 1481
689 1473



CHRYSLER CIRRUS (95-00) DODGE
STRATUS (95-00) CON PERNO

HO391

BALATAS
2196 781



SEGURO PARA FRENO DE ESTACIONAMI-
ENTO CHEVROLET PICK-UP, BLAZER, C1500
(95-00), SILVERADO 1500 (05-09)

HO420R

BALATAS
13X0 FT003
994 1665



SEGURO ALAMBRE PARA FRENO DE
TAMBOR CHEVROLET CHEVY (94-12)
LADO R

HO420L

BALATAS
13X0 FT003
994 1665



SEGURO ALAMBRE PARA FRENO DE
TAMBOR CHEVROLET CHEVY (94-12)
LADO L

RS283



RESORTE PARA SEPARADOR DE
BALATA UNIVERSAL

RS283D



RESORTE PARA SEPARADOR DE
BALATA CHEVROLET CAVALIER (90-95)

RS400



RESORTE PARA PALANCA DE AJUSTE
CHEVROLET MALIBU (75-86)

PARTES PARA FRENO

HO252

MEDIDAS
Ø. 9.50 mm
h. 37 mm



PERNO PARA CILINDRO DE RUEDA
UNIVERSAL

HO252A

MEDIDAS
Ø. 9.50 mm
h. 38 mm



PERNO PARA CLINDRO DE RUEDA
UNIVERSAL

HO252B

MEDIDAS
Øc. 9.50 mm
L. 38 mm



PERNO PARA CILINDRO DE RUEDA
UNIVERSAL

HO273

MEDIDAS
Ø. 10 mm x 1
h. 29 mm



TORNILLO PARA FRENO DE DISCO
UNIVERSAL

HO273A

MEDIDAS
ROSCA:
Ø. 10 mm
STD x 1.5
h. 33 mm



TORNILLO PARA FRENO DE DISCO

HO273B

MEDIDAS
Øc. 10 mm
x 1.5
h. 30 mm



TORNILLO PARA FRENO DE DISCO GM
CHEVROLET ASTRO (92-05)

HO273C

MEDIDAS
Ø. 10 mm
x 1.5
h. 36 mm



TORNILLO PARA FRENO DE DISCO FORD
AEROSTAR, EXPLORER (91-99), RANGER
(85-92)

HO273D

MEDIDAS
ROSCA:
Ø. 10 mm
x 1.5
h. 34.35 mm



FORD LTD CROWN VICTORIA (87-91),
MERCURY THUNDERBIRD (94-97),
COUGAR (93-98)

HO273E

MEDIDAS
ROSCA:
Ø. 7/16"-20
h. 34 mm



CHRYSLER 300 (12-14)
TRACCIÓN TRASERA

HO273F

MEDIDAS
ROSCA:
Ø. 11 mm
x 1.25
h. 30.20 mm



CHRYSLER TRACCIÓN DELANTERA (-)

HO273G

MEDIDAS
ROSCA:
Ø. 7/16"-20
h. 32.50 mm



CHEVROLET SILVERADO
1500 (01-06)

HO273H

MEDIDAS
ROSCA:
Ø. 10 mm
x 1
h. 29.60 mm



FORD ESCORT

HO273I

MEDIDAS
ROSCA:
Ø. 3/8"-24
h. 32.65 mm



FORD PICK UP

HO273J

MEDIDAS
ROSCA:
Ø. 3/8"-24
h. 28.70 mm



FORD UNIVERSAL

HO273K

MEDIDAS
ROSCA:
Ø. 10 mm
x 1
h. 36.60 mm



GMC SAVANA 1500 (03-08)
MODELOS VIEJOS

PARTES PARA FRENO



HO273L MEDIDAS
ROSCA:
Ø. 12 mm
x 1
h. 29.45 mm



VW, AUDI A4 (99-05)

HO273M MEDIDAS
ROSCA:
Ø. 10.00 mm
x 1
h. 45.30 mm



FORD UNIVERSAL

HO273N MEDIDAS
ROSCA:
Ø. 10.00 mm
x 1
h. 40.30 mm



FORD

HO273P MEDIDAS
ROSCA:
Ø. 10.00 mm
x 1
h. 32.60 mm



NISSAN UNIVERSAL

HO273R MEDIDAS
Ø. 10.00 mm
x 1.5
L. 00 mm
Øc. 00 mm



DODGE DAKOTA (95-00),
DURANGO, FORD UNIVERSAL

HO273S MEDIDAS
ROSCA:
Ø. 9.5 mm
h. 29.50 mm



FORD EXPLORER (91-99),
RANGER (95-98)

HO273T MEDIDAS
ROSCA:
Ø. 10.00 mm
h. 30.20 mm



FORD LTD CROWN VICTORIA (87-91),
THUNDERBIRD (94-97), LINCOLN,
MERCURY COUGAR (93-98)

HO274



SUJETADOR MANGUERA TIPO
UNIVERSAL (CHICO)

HO274A



SUJETADOR MANGUERA TIPO
UNIVERSAL (GRANDE)

HO296 1/8" X 1 1/2"



CHAVETAS PARA RUEDA
UNIVERSAL

HO296O 5/32" X 1 1/2"



CHAVETAS PARA RUEDA
UNIVERSAL

HO296A 3/32" X 1 1/2"



CHAVETAS PARA RUEDA
UNIVERSAL

HO297 3/16" X 2 1/2"



CHAVETAS PARA RUEDA
UNIVERSAL

HO298 3/16 X 3"



CHAVETA VW COMBI 3/16 X 3"

HO301 BALATAS
T30 30
CAMARA



TORNILLO LIBERACION BERG PARA
FRENO DE AIRE UNIVERSAL

* TODOS LOS PISTONES INCLUYEN LIGA Y SILICÓN

*Ø. = DIÁMETRO EXTERIOR
*h. = ALTURA
*CE. = CÓDIGO EQUIVALENTE

PARTES PARA FRENO

HO303



ALAMBRE PARA RODILLO
FRENO DE AIRE

HO361

MEDIDAS
Ø. 11 mm
h. 34 mm



TORNILLO PARA FRENO DE
DISCO FORD

HO680

3/8"x1/2"



RONDANAS DE COBRE PARA
MANGUERAS DE FRENO DE DISCO
UNIVERSAL

HO680A

13/32"x5/8"



RONDANAS DE COBRE PARA
MANGUERAS DE FRENO DE DISCO
UNIVERSAL

HO681

7/16"x11/16"



RONDANAS DE COBRE PARA
MANGUERAS DE FRENO DE DISCO
UNIVERSAL

HO681A

1/2"x13/16"



RONDANAS DE COBRE PARA
MANGUERAS DE FRENO DE DISCO
UNIVERSAL

HO682

11/32"x9/16"



RONDANAS DE COBRE PARA
MANGUERAS DE FRENO DE DISCO
UNIVERSAL

HO682A

16.70 mm x 11.20 mm



RONDANAS DE COBRE PARA
MANGUERAS DE FRENO DE DISCO
UNIVERSAL

HO682B

15.90 mm x 10.00 mm



RONDANAS DE COBRE PARA
MANGUERAS DE FRENO DE DISCO
UNIVERSAL

HO682C

15.90 mm x 10.00 mm



RONDANAS DE COBRE PARA
MANGUERAS DE FRENO DE DISCO
UNIVERSAL

HO682D

9/16"x7/8"



RONDANAS DE COBRE PARA
MANGUERAS DE FRENO DE DISCO
UNIVERSAL

HO683

7/32"x1/2"



RONDANAS DE COBRE PARA
MANGUERAS DE FRENO DE DISCO
UNIVERSAL

HO684

11/32"x9/16"



RONDANAS DE COBRE PARA
MANGUERAS DE FRENO DE DISCO
UNIVERSAL

HO743

C.E. (80743)
MEDIDAS
Ø. 7/16"
h. 52 mm







PERNO PARA CILINDRO DE RUEDA
UNIVERSAL

**Encuentra éstas
y miles de
aplicaciones
más en:**

hoautopartes.mx

PURGADORES PARA FRENO



HO950 NISSAN UNIVERSAL		MEDIDAS 7.90 x 25.40 mm C.E. (600)	HO951 DODGE UNIVERSAL		MEDIDAS 6.30 mm C.E. (6446)
HO952 CHEVROLET Y FORD UNIVERSAL		MEDIDAS 9.50 mm C.E. (6858)	HO953 DODGE UNIVERSAL		MEDIDAS 7.90 x 30.15 mm C.E. (10591)
HO954 FORD UNIVERSAL		MEDIDAS 11.10 mm C.E. (11410)	HO955 UNIVERSAL CHEVROLET Y DODGE		MEDIDAS 9.50 mm C.E. (11579)
HO956 UNIVERSAL CHEVROLET Y DODGE		MEDIDAS 11.10 mm C.E. (11596)	HO957 UNIVERSAL FORD CAMIÓN		MEDIDAS 11.10 mm C.E. (24493)
HO958 UNIVERSAL CHEVROLET, DODGE Y FORD		MEDIDAS 7.90 mm C.E. (57188)	HO959 VW SEDAN (82-04)		MEDIDAS 6.00 mm C.E. (90549-D)
HO960 VW ATLANTIC (84-97), CARIBE, COMBI		MEDIDAS 6.00 mm C.E. (96402-D)	HO961 UNIVERSA GMC		MEDIDAS 23.81 x 7.90 mm C.E. (105182)
HO962 NISSAN PICKUP (84-89) DATSUN, TSURU, TOYOTA		MEDIDAS 10 X 33 mm C.E. (105396)	HO963 UNIVERSAL CHEVROLET		MEDIDAS 10.00 mm C.E. (105407)
HO964 VW COMBI PANEL (73-01)		MEDIDAS 7.00 mm C.E. (105408)	HO965 CHEVROLET, KODIAK, MERCEDES BENZ		MEDIDAS 11.10 mm
HO966 CHEVROLET CHEVY MONZA (03)		MEDIDAS 7.90 x 27.00 mm	HO967 UNIVERSAL HONDA		MEDIDAS 34.90 x 7.90 mm
HO966A CHEVROLET MONZA (03)		MEDIDAS 7.90 x 27.00 mm	HO981 FORD FIESTA (03-10)		MEDIDAS 7.90 x 9.50 mm
HO982 RENAULT MEGANE (04-09)		MEDIDAS 7.00 mm	HO983 FORD IKON (04-07), AUDI, VW, CHEVROLET		MEDIDAS 10.00 mm

JUEGO DE CLAVOS PARA ZAPATA CHICOTES PARA FRENO DE MANO

HO072

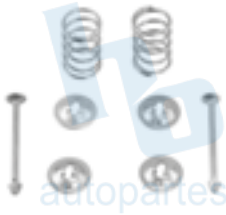

No. 1 CHRYSLER,
FORD TOPAZ (84-94), NISSAN
49.00 mm

HO073



No. 2 FORD
FAIRMONT (78-83),
MERCURY COUGAR
(89-92), VALIANT
54.00 mm

HO074



No. 3 CHEVROLET
C15 (82-88),
DODGE, FORD
60.00 mm

HO075



No. 4 CHEVROLET
C15 (82-87), PICK UP,
C1500 SUBURBAN
(92-99) 68.00 mm

HO076

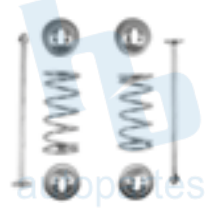

No. 5 CHEVROLET
C30 (75-81), C35
(90-96), MICROBUS
73.00 mm

HO076H



S/N HINO
UNIVERSAL

HO140

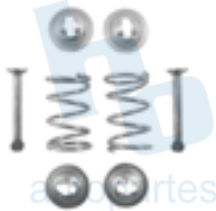

No. 0 VW
SEDÁN (68-72),
SEDÁN (77-94),
DELANTERA
34.00 mm

HO141

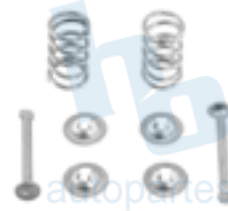

No. 00 VW
SEDAN (68-72),
SEDAN (77-94)
TRASERA
39.00 mm

HO141A



No. 6 DATSUN
SEDAN (72-83)
46.00 mm

HO141B

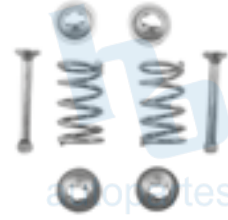

S/N. VW
CARIBE 37 mm

HO141C



No. 7 NISSAN
TSURU 43 mm

HO141D

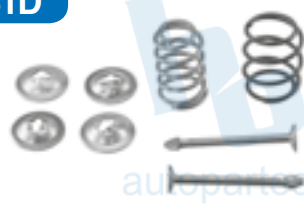

S/N. CHEVROLET
CAVALIER 46 mm

HO141E

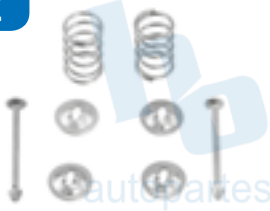

S/N. CHEVROLET
CHEVY MONZA (03)
37.00 mm

HO128



Ø TAMBOR 10" 250.50 mm

FORD AEROSTAR (86-89), FAIRMONT (78-83), MAVERICK (70-77),
MUSTANG (84-88), CHRYSLER CORDOBA (75-82), LEBARON (77-95),
VALIANT (76-80), DODGE CORONET (68-70), DART (73-82),
PLYMOUTH DUSTER (73-82), VOLARE (76-80)

JUEGO DE CLAVOS PARA ZAPATA CHICOTES PARA FRENO DE MANO



HO129

Ø TAMBOR 11" 290.00 mm



DODGE D100 (75-85), MONACO (90-92), FORD E150 ECONOLINE (75-96), F100 (77-83), F150 (76-86), FORD LTD (79-82), GALAXIE 500 (70-73), MERCURY GRAND MARQUIS (82-84)

HO178



DODGE D100 (75-85) 11" 290.50 mm

HO178A



CHRYSLER CARAVAN, PLYMOUTH VOYAGER, TAMBOR 10 84-95" 250.50 mm

HO180



DODGE D300 (75-80), D350 (81-93), FORD F350 (68-98) 12.130" 370.00 mm

HO379



FORD RANGER (83-94) 9" 220.00 mm

HO380



DODGE DURANGO (98-02), FORD E150 ECONOLINE (95-05), LOBO (05-12) 11.030" 322.50 mm

HO159



ROJO DODGE D300 (75-80), D350 (81-93), FORD F350 (73-96) (R)

HO160



AZUL DODGE D350 (81-93), FORD F300, F350 (73-96) (L)

HO157



GUIA STANDARD PARA CHICOTE

HO158



GUIA PARA CHICOTE FORD F350 (68-98)

HO693



SEGURO FRENO DE MANO AUTOMATICO VW CARIBE (77-87) GOLF Y JETTA (93-99), POINTER (99-03)

BALATAS
559 1354
662 1450
495 1353

HO952T

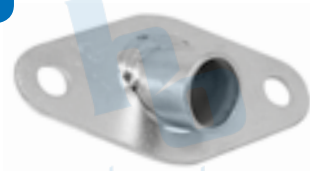

GUIA PARA CHICOTE DE CLUTCH NISSAN TSURU (92-17)

hoautopartes.mx

JUEGO DE RESORTES PARA BALATA

HO649

**PARA ACCELERADOR DE TENSION
BOLSA SURTIDA CON 30 PZAS. DE
VARIOS GRUESOS Y LARGOS
UNIVERSAL**

JR1000 BALATAS
1354 559

**VW ATLANTIC (84-97), CABRIOLET (85-93),
CARIBE (77-87), GOLF (86-92), JETTA (80-92),
POINTER (02-09), SCIROCCO (77-89)**

JR1001 BALATAS
852A 269

**VW SEDAN (77-88)
RUEDA DELANTERA**

JR1002 BALATAS
270 882A
315

VW SEDAN (73-94) RUEDA TRASERA

JR1003 BALATAS
421

VW COMBI (74-98) RUEDA TRASERA

JR1004 BALATAS
1450 S662

VW GOLF GTI, JETTA (93-99)

JR1005 BALATAS
1353 495

VW POINTER (01-03)

JR1100 BALATAS
1315 504

DODGE DART (82-89)

JR1101 BALATAS
2012AT 151
2089T 333
2089T 445
154
155

**DODGE DART (67-82), CAMIONETA D100
(75-85), D150 (77-93), PLYMOUTH VALIANT
(73-82)**

JR1102 BALATAS
1366 520

**CHRYSLER PT. CRUISER (01-06),
SHADOW, SPIRIT (89-94)**

JR1103 BALATAS
1456 S657

DODGE SHADOW (89-94), SPIRIT (93-95)

JR1104L BALATAS
2168 538
2176 538

**CHRYSLER GRAND VOYAGER (91-97),
DODGE CARAVAN (84-85), DAKOTA (98-
00), JEEP CHEROKEE (97-01) IZQUIERDO**

JR1104R BALATAS
2168 538
2176 538

**CHRYSLER GRAND VOYAGER (91-97),
DODGE CARAVAN (84-85), DAKOTA (98-
00), JEEP CHEROKEE (97-01) DERECHO**

JR1108 BALATAS
2134BTT S652

DODGE RAM 1500 (99-00)

JR1109L **JR1109R** BALATAS
1481 S698

DODGE STRATUS (95-98)

JR1110 BALATAS
2025 446

DODGE RAM 1500 (95-97) 5 BIRLOS

JR1111 BALATAS
854 2129
771 2250

**DODGE RAM 400 (00-01)
FRENO DE MANO**

JR1112 BALATAS
1465 ATT 714
1485 703

**CHRYSLER TOWN & COUNTRY (97-01),
CHRYSLER VOYAGER (01-03)**

JUEGO DE RESORTES PARA BALATA



JR1113L BALATAS
2174TT 670

DODGE DAKOTA (87-99), JEEP GRAND CHEROKEE (94-96) IZQUIERDO

JR1113R BALATAS
2174TT 670

DODGE DAKOTA (87-99) JEEP GRAND CHEROKEE (94-96) DERECHO

JR1114L BALATAS
2174TT S774

JEEP LIBERTY SPORT IZQUIERDO (02-03)

JR1114R BALATAS
2174TT S774

JEEP LIBERTY SPORT DERECHO (02-03)

JR1115 BALATAS
951

DODGE RAM CHARGER (98-00)

JR1116L BALATAS
2025T 446

DODGE RAM VAN WAGON TRADESMAN IZQUIERDO (91-97)

JR1116R BALATAS
2025T 446

DODGE RAM VAN WAGON TRADESMAN DERECHO (91-97)

JR1117L BALATAS
2087T 445

DODGE DAKOTA IZQUIERDO (87-99)

JR1117R BALATAS
2089T 445

DODGE DAKOTA DERECHO (87-99)

JR1119 BALATAS
2168T 538

CHRYSLER GRAND VOYAGER, PLYMOUTH VOYAGER (91-95)

JR1120 BALATAS
2080 264

DODGE PICK UP D100 (75-85), D150 (77-93)

JR1121 BALATAS
643 1441

CHRYSLER PT CRUISER (01-02)

JR1122 BALATAS
771 2192

DODGE RAM 3500, 4000, 6000 (00-02)

JR1123 BALATAS
1473 S689

DODGE NEON (95-05)

JR1124 BALATAS
1445 S658

CHRYSLER CIRRUS (95-05), DODGE STRATUS (02-05)

JR1200 BALATAS
2165T 507
2165T 518
2165T 521

CHEVROLET CELEBRITY, CITATION (82-84)

JR1201 BALATAS
2117ATT 242
2117ATT 514

CHEVROLET CAPRICE (71-82), MALIBU (75-82)

JR1202 BALATAS
2073 473
228

CHEVROLET C10 (75-86)

* TODOS LOS PISTONES INCLUYEN LIGA Y SILICÓN

*Ø. = DIÁMETRO EXTERIOR
*h. = ALTURA
*CE. = CÓDIGO EQUIVALENTE

JUEGO DE RESORTES PARA BALATA

JR1203 BALATAS
2042BT S655
2157AT S656

CHEVROLET C35 (90-00)

JR1204 BALATAS
2165T
552

BUICK CENTURY (79-92),
OLDSMOBILE CUTLASS (87-94)

JR1205 BALATAS
2164 553

CHEVROLET CAVALIER (90-98)

JR1206 BALATAS
1404A 675
593

CHEVROLET S10 BLAZER (83-94),
SILVERADO (95-99)

JR1207 BALATAS
1487
S636

BUICK CENTURY (94-00),
OLDSMOBILE CUTLASS (97-99)

JR1208 BALATAS
13X0 FT003
994 1665

CHEVROLET CHEVY MONZA (03)

JR1209L BALATAS
8428 951
2X64 FT001

CHEVROLET CHEVY PICK UP
IZQUIERDO (99-03)

JR1209R BALATAS
8428 951
2X64 FT001

CHEVROLET CHEVY PICK UP (99-03)

JR1211L BALATAS
1506 738

CHEVROLET GEO TRACKER
IZQUIERDO (99-01)

JR1211R BALATAS
1506
738

CHEVROLET GEO TRACKER
DERECHO (99-01)

JR1212L BALATAS
1492
S711

CHEVROLET TRACKER IZQUIERDO
(03-04)

JR1212R BALATAS
1492
S711

CHEVROLET TRACKER
DERECHO (03-04)

JR1213 BALATAS
2042 S655
2157 S656

CHEVROLET C15 (82-88), C1500
SUBURBAN (92-99)

JR1214 BALATAS
2117 514

CHEVROLET KS BLAZER (78-86),
S10 (84-02)

JR1216 BALATAS
12X3 FT008
995 1666

PONTIAC MATIZ (04-10),
CHEVROLET MATIZ (11-15)

JR1217 BALATAS
13X0 FT003
994 1665

CHEVROLET CHEVY JOY (99-12), MONZA
(03), CORSA (02-08), MERIVA (04-05)

JR1218 BALATAS
2192
S771

CHEVROLET VORTE CR 36
CAMIONETA 3.5 TON (03-04)

JR1219 BALATAS
1500
S780

PONTIAC AZTEK (01-02)

JUEGO DE RESORTES PARA BALATA



JR1220 BALATAS
1516 S751

autopartes

CHEVROLET MERIVA (04),
ASTRA(00-06), TORNADO (04-17)

JR1221 BALATAS
1535 S795

autopartes

CHEVROLET CAVALIER
(04-05)

JR1234 BALATAS
1540
S800

CHEVROLET HHR (06-11)

JR1300 BALATAS
2121 263

FORD GALAXIE 500 (70-73)

JR1301 BALATAS
2012AT
151

autopartes

FORD FAIRMONT (78-83), MUSTANG
(74-88), AMC AMERICAN (62-68), VAM
AMERICAN (73-80)

JR1302 BALATAS
2081TT 264
2141 263
2141 582

DODGE D150 (77-93), RAM CHARGER
(92-96), FORD F100 (77-83), F150 (76-96)

JR1303 BALATAS
2131 2137
2171 583
314

autopartes

DODGE D300 (75-80), D350 (81-93),
FORD F350 DERECHO (68-98)

JR1304 BALATAS
2131 2137
2171 583
314

autopartes

DODGE D300 (75-80), D350 (81-93),
FORD F350 IZQUIERDO (68-98)

JR1305 BALATAS
1350 501

FORD TOPAZ (84-94)
GHIA (91-93)

JR1306 BALATAS
1395 566

autopartes

FORD TAURUS (87-94)

JR1307 BALATAS
2182TT 723
2182T 734

autopartes

DODGE DURANGO, FORD
LOBO DERECHO (98-00)

JR1308 BALATAS
2182TT 723
2182T 734

autopartes

DODGE DURANGO, FORD
LOBO IZQUIERDO (98-00)

JR1309 2151T 474
2151T 569

autopartes

FORD AEROSTAR (87-94) BRONCO
(91-96), EXPLORER (91-00), RANGER
(83-94)

JR1310 1396 S618
1452 S665

FORD THUNDERBIRD (89-92),
WINDSTAR (95-98), MERCURY COUGAR
(93-01), NISSAN QUEST (93-02)

JR1312L 953
2209 1000

autopartes

FORD FIESTA (98-01), FORD IKON
(04-07), FORD KA (01-08) (IZQUIERDO)

JR1312R BALATAS
2209 1000
953

autopartes

FORD FIESTA (98-01), FORD IKON
(04-07), FORD KA (01-08) (DERECHO)

JR1313L BALATAS
2089AT
705

autopartes

FORD RANGER (98-00) IZQUIERDO

JR1313R BALATAS
2089AT
705

autopartes

FORD RANGER (98-00) DERECHO

* TODOS LOS PISTONES INCLUYEN LIGA Y SILICÓN

*Ø. = DIÁMETRO EXTERIOR
*h. = ALTURA
*CE. = CÓDIGO EQUIVALENTE

JUEGO DE RESORTES PARA BALATA

JR1314

BALATAS
847 1577



FORD F350 SUPER DUTY (99-00)
FRENO DE MANO

JR1315

BALATAS
1396 S618
1452 S665



FORD TAURUS (00-01)

JR1316L

BALATAS
1463 S678

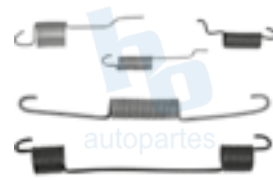

FORD ESCORT IZQUIERDO (94-96)

JR1316R

BALATAS
1463 S678



FORD ESCORT DERECHO (94-96)

JR1317

BALATAS
2089AT 581

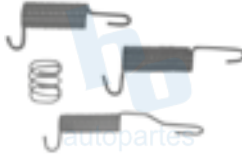

FORD AEROSTAR (87-96)
RANGER (84-88) EXPLORER (91-99)

JR1318

BALATAS
752 1517



FORD EXPEDITION (97-02) F150 (99-11)
LINCOLN MARK LT (06-08)
FRENO DE MANO

JR1319

BALATAS
701 1484
766 1484



FORD EXPLORER (95-01), EXPLORER
EXPORT (01-03), MOUNTAINER (97-01),
SPORT TRACK (01-05), MERCURY GRAND
MARQUIS (95-01)

JR1320

BALATAS
1524 S760



FORD ESCAPE (01-07) MERCURY
MARINER (05-07) MAZDA TRIBUTE (01-09)

JR1321L

BALATAS
1504 S736



FORD COURIER IZQUIERDO (01-12)

JR1321R

BALATAS
1504 S736

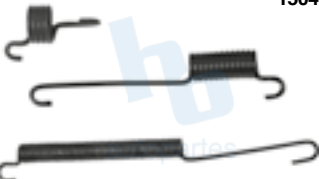

FORD COURIER DERECHO (01-12)

JR1322L

BALATAS
1504 S704



FORD RANGER (95-02), MAZDA
B2600 (87-03) IZQUIERDO

JR1322R

BALATAS
2185T S704



FORD RANGER (95-02), MAZDA
B2600 (87-03) DERECHO

JR1324L

BALATAS
9967 8444



FORD FIESTA (02-03), KA (01-08)
IZQUIERDO

JR1324R

BALATAS
2X99 FT010

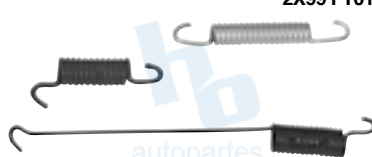

FORD FIESTA (02-03), KA (01-08)
DERECHO

JR1325

BALATAS
1622 S920
2195 S809



FORD GRAND MARQUIS (03-05), DODGE
CHARGER (06-17), CHALLENGER (09-17),
CHRYSLER PACIFICA (04-08), LINCOLN TOWN
CAR (96-98)

JR1326

BALATAS
2089AT S705



FORD RANGER 10" (95-98)

JR1327L

BALATAS
2182TT S723



FORD LOBO F-150, F-250 IZQUIERDO (97-01)

JR1327R

BALATAS
2182TT S723

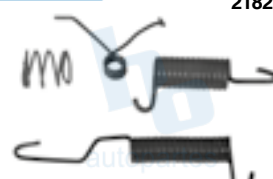

FORD LOBO F-150, F-250 DERECHO (97-01)

JUEGO DE RESORTES PARA BALATA



JR1328 BALATAS
1452 S665

FORD WINDSTAR (95-03)

JR1329 BALATAS
752 1517

FORD LOBO F150, F250 (97-01)

JR1330L BALATAS
1395 599

FORD SABLE (94-01) IZQUIERDO

JR1331R BALATAS
1395 599

FORD SABLE (94-01) DERECHO

JR1332 BALATAS
2X99 FT010
993 1664

FORD ECOSPORT (04-10), FIESTA (03-04), FORD COURIER (01-12)

JR1338 BALATAS
1651 974

FORD TRANSIT (07-13)

JR1400 BALATAS
1341 480

DATSUN SEDAN (70-83), NISSAN ICHI VAN (88-94), RUEDA TRASERA

JR1401 BALATAS
8123 406

NISSAN, DATSUN PICK UP (78-83)

JR1402 BALATAS
1399 4011

NISSAN DATSUN PICK-UP RUEDA DELANTERA (70-83)

JR1403 BALATAS
1373 532

NISSAN TSURU (84-87), TSURU (87-91)

JR1404 BALATAS
8123 405

NISSAN DATSUN PICK-UP AMERICANA RUEDA DELANTERA (78-81)

JR1405 BALATAS
1438 S638

NISSAN TSURU (92-17), SENTRA (96-00)

JR1406 BALATAS
1399 574

NISSAN PICK UP (95-13), RUEDA TRASERA NP300 (09-13), D22 FRONTIER (98-13), D21

JR1407 BALATAS
1433 S631

NISSAN PATHFINDER (96-04), XTERRA (00-04), PICK UP 4WD (93-97) FRONTIER 4WD (98-04)

JR1408 BALATAS
1X20 952
FT006
1029 1695

NISSAN PLATINA (02-10) RENAULT CLIO (02-10)

JR1409 BALATAS
8106 533

NISSAN SENTRA U.S.A. (87-90)

JR1410 BALATAS
1381 575
1381 607

NISSAN TSUBAME (95-03)

JR1411 BALATAS
1433 631

NISSAN FRONTIER, URVAN (02-03)

* TODOS LOS PISTONES INCLUYEN LIGA Y SILICÓN

*Ø. = DIÁMETRO EXTERIOR
*h. = ALTURA
*CE. = CÓDIGO EQUIVALENTE

JUEGO DE RESORTES PARA BALATA

JR1413

BALATAS
1457 S671



NISSAN ALTIMA (93-00)

JR1414

BALATAS
1381 607



NISSAN MAXIMA (83-93)

JR1415

BALATAS
762 1525



NISSAN SENTRA (01-03)

JR1500

BALATAS
1360 S619



CHEVROLET LUV (97-05), ISUZU PICK UP (88-95), HONDA PASSPORT (94-96), AMIGO (89-94), ISUZU RODEO (91-98)

JR1501

BALATAS
1379 S707

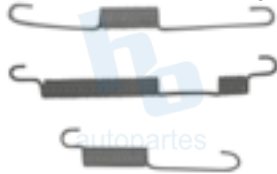

DODGE ATOS (01-12)

JR1502

BALATAS
1344 565

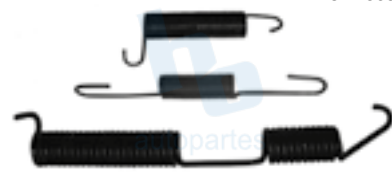

MAZDA B2600 (87-93)

JR1503

BALATAS
1448 S661



HYUNDAI ELANTRA (92-95)

JR1504

BALATAS
6670
1389 558



MITSUBISHI LANCER (89-91)

JR1508

BALATAS
1528 S778



MITSUBISHI LANCER (02-03)

JR1509

BALATAS
1445 S658



MITSUBISHI GALANT (03-04)
ECLIPSE (02-05)

JR1510

BALATAS
1499 S728

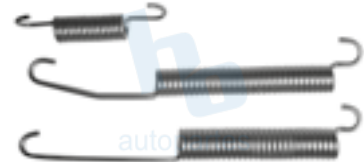

MITSUBISHI MONTERO SPORT (02-03)

JR1511

BALATAS
1538 S798



MITSUBISHI OUTLANDER (03-04)

JR1600

BALATAS
2012AT 151

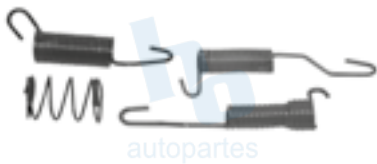

A. M. RAMBLER (69)

JR1600T

BALATAS
1358 505



TOYOTA PICK UP (84-94)

JR1601T

BALATAS
1397 589



TOYOTA LAND CRUISER (75-90)

JR1603

BALATAS
8105 551

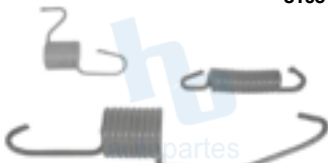

TOYOTA COROLLA (83-88)

JR1605

BALATAS
1X24 FT-009
1692 1025



DODGE H100 GASOLINA (03-05)

JR1606

BALATAS
1529 785



TOYOTA COROLLA MATRIX (02-06)

JUEGO DE RESORTES PARA BALATA



JR1607 BALATAS
1385 587

TOYOTA CAMRY (01-02)

JR1608 BALATAS
1518 S754
1518 S754

TOYOTA YARIS (01-02)

JR1609 BALATAS
1500 S729
1358 S804

TOYOTA SIENNA (02-10)

JR1610 BALATAS
846 1576

TOYOTA RAV4 (01-02)

JR1611 BALATAS
1447 587

TOYOTA CAMRY (05-06)

JR1700 BALATAS
1364 576
1379 S639

HONDA CIVIC (92-15)

JR1701 BALATAS
1429 S627

HONDA ACCORD (90-00)

JR1702 BALATAS
1512 S744

HONDA ODYSSEY (99-01)

JR1800 BALATAS
4241L6
1698 S1032

PEUGEOT PARTNER (03-12),
GRAND RAID (07-12)

JR1801L BALATAS
956
942 1633

PEUGEOT 206 IZQUIERDO (02-08)

JR1801R BALATAS
956
942 1633

PEUGEOT 206 DERECHO (02-08)

JR1802 BALATAS
7701205517
1694 S1028

RENAULT KANGOO (07-09)

JR1900 BALATAS
1414 608
1489 724

CHEVROLET METRO (98-01),
SUZUKI SWIFT (98-01)

JR1901L BALATAS
660 1446

SUZUKI SIDEKICK L (91-98)

JR1901R BALATAS
660 1446

SUZUKI SIDEKICK R (91-98)

JR1903L BALATAS
1483 641
1440 641

SUZUKI VITARA (92-95)

JR1903R BALATAS
1483 641
1440 641

SUZUKI VITARA (92-95)

JR2000 BALATAS
1632 940

MERCEDES BENZ SPRINTER 3500 (07-09)

* TODOS LOS PISTONES INCLUYEN LIGA Y SILICÓN

*Ø. = DIÁMETRO EXTERIOR
*h. = ALTURA
*CE. = CÓDIGO EQUIVALENTE

HO162

VW SEDAN (73-94)
DELANTERA Y
TRASERA
(2 POR RUEDA) R y L

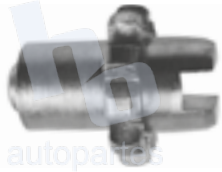

BALATAS
881 A 269
882A 315
TAMBOR
251.96mm

HO163

VW COMBI (74-98)
(2 POR RUEDA)
R y L



BALATAS
8080 503
8080 421
TAMBOR
251.96mm

HO162AR

TAMBOR
180.08mm



VW CARIBE R y L (77-85)

HO162AL

BALATAS
1354 497

HO194R

TAMBOR
199.89mm



CHEVROLET CHEVY MONZA (03), CORSA (02-08) R y L

HO194L

BALATAS
13X0 FT003
427

HO195R

TAMBOR
199.89mm



CHEVROLET CAVALIER R y L (90-95)

HO195L

BALATAS
2164
553

HO196R

TAMBOR
225.04mm



OLDSMOBILE CUTLASS R y L (87-94)

HO196L

BALATAS
2165 T552

HO197

TAMBOR
254mm

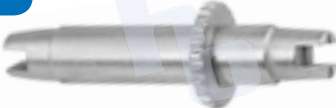

DODGE D100 (75-85) CORTO R y L

HO198

BALATAS
2012 151

HO199

TAMBOR
279.4mm

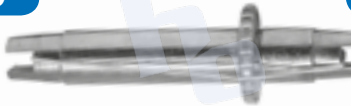

UNIVERSAL LARGO R y L

HO200

BALATAS
2012
151

HO201

TAMBOR
308.10mm

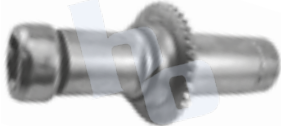

FORD F-350 R y L (68-98)

HO202

BALATAS
2137 314
2171 583

HO203

TAMBOR
308.10mm

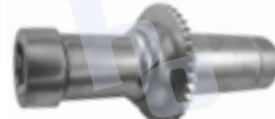

DODGE D300 (75-80), D350 R y L (81-93)

HO204

BALATAS
2137 314
2171 583

HO205

TAMBOR
330.2mm



CHEVROLET C30 R y L (75-81)

HO206

BALATAS
2157AT S656
2042BT S655

HO205A

TAMBOR
308.10mm



CHEVROLET C35 R y L (90-00)

HO206A

BALATAS
2157AT S656
2042BT S655

HO236

TAMBOR
308.10mm



DODGE D100 (75-85), MONACO R y L (90-92)

HO237

BALATAS
2168 538
2089AT 705

HO246

TAMBOR
308.10mm



FORD TOPAZ (84-94) R y L

HO247

BALATAS
1350 501

HO248

TAMBOR
308.10mm



CHRYSLER "K" (83-93) R y L

HO249

BALATAS
415 520

HO248A



CHRYSLER SHADOW (89-94), DODGE SPIRIT (94-95) R y L

HO249A

BALATAS
1456 S657
TAMBOR
308.10mm

HO250AR

DATSUN PICK-UP R y
L (A-720) (A-620 U.S.A.)
CON SEGUROS (70-83)
DELANTERO Y TRASERO

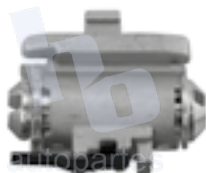

HO250AL

BALATAS
8123 406
8123 405
TAMBOR
254mm

HO250



JUEGO DE SEGUROS DE AJUSTADOR
DATSUN PICK-UP (70-83)

BALATAS
8123 406

AJUSTADORES PARA BALATA



HO251



BALATAS
1354 497

SEGURO DE AJUSTADOR VW CARIBE (77-85)

HO254



HO255

BALATAS
1373 532
TAMBOR
180.08mm

NISSAN TSURU (84-87) Y TSURU (87-91) (R)

HO254AR



HO255AL

BALATAS
1438 S638
TAMBOR
180.08mm

NISSAN TSURU (92-17) (R)

HO276



HO277

BALATAS
1404A S675
1404 593
TAMBOR
254mm

CHEVROLET C1500 (88-94), C1500 SUBURBAN (92-99), S10
BLAZER (83-94), TAHOE (95-00), GMC YUKON (92-94) (R)

HO276A



HO277A

BALATAS
1506 738
TAMBOR
219.96mm

CHEVROLET GEO TRACKER R y L (99-06)
SUZUKI VITARA, GRAND VITARA (99-05)

HO276B



HO277B

BALATAS
1492 S711
TAMBOR
254mm

CHEVROLET GEO TRACKER 4W R y L (96-04)

HO278



HO279

BALATAS
1399 574
TAMBOR
260.09mm

NISSAN D21 (89-94) R y L FRONTIER (98-10),
PICK UP (95-08), URVAN (00-13)

HO278A



HO279A

BALATAS
1358 505
TAMBOR
254mm

TOYOTA PICKUP (81-95) R y L

HO317



HO318

BALATAS
1395 566
TAMBOR
225.04mm

FORD THUNDERBIRD (89-97) R y L

HO329

JUEGO DE LEVA AJUSTADOR
DE BALATA DELANTERA
DATSUN SEDAN (72-83)
(R y L) NACIONAL

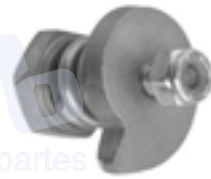

BALATAS
4011 8446
TAMBOR
254mm

HO333



HO334

BALATAS
1396 S618
TAMBOR
249.93mm

MERCURY COUGAR (89-92), SABLE (94-01), FORD
WINDSTAR (95-04) R y L

HO346



HO347

BALATAS
1487 S636
1496 S720
TAMBOR
225.04mm

BUICK CENTURY OLDSMOBILE
CUTLASS (87-94) R y L

HO400R



HO400L

BALATAS
1397 589
TAMBOR
293.62mm

TOYOTA LAND CRUISER (75-90) 4RUNNER (85-00) R y L

HO402R



HO402L

BALATAS
8089 407
TAMBOR
228.6mm

AJUSTADOR BALATA TOYOTA CRESSIDA (78-80) R y L

HO403R



HO403L

BALATAS
8105 551
TAMBOR
200.15mm

TOYOTA COROLLA R y L (83-88)

HO406R



HO406L

BALATAS
1360 S619
TAMBOR
254mm

CHEVROLET LUV (97-05) ISUZU PICK UP R y L (88-95)

HO412R



HO412L

BALATAS
1379 S707
TAMBOR
180.08mm

DODGE ATOS R y L (01-12)

HO412AR



HO412AL

BALATAS
1685 1016
TAMBOR
292.73mm

MITSUBISHI L200 R y L (10-12) ISUZU DMAX
4WD COLORADO (13-15)

*Ø. = DIÁMETRO EXTERIOR

*h. = ALTURA

* TODOS LOS PISTONES INCLUYEN LIGA Y SILICÓN

*CE.= CÓDIGO EQUIVALENTE

FRENOS HO 2024-2025

89

HO414R



HO414L

BALATAS
1429 627
TAMBOR
219.96mm

HONDA ACCORD R y L, 4 Y 6 CILINDROS (90-00)

HO416R



HO416L

BALATAS
1364 576
1379 S639
TAMBOR
199.89mm

HONDA CIVIC R y L (92-00)

HO418R



HO418L

BALATAS
1344 565
TAMBOR
260.09mm

MAZDA PICK UP R y L (86-93), MAZDA 4X2 (89-96), MAZDA B1800 (77-78), B2000 (79-87), B2200 (87-93), B2300 (94-10), B 2600 (87-03)

HO429R



BALATAS
1X20 FT006
1029 1695
952
TAMBOR
212.44mm

NISSAN PLATINA R y L (02-05)

HO429A



BALATAS
1651 S974
16X4 FT073
1689 1020
TAMBOR
204.57mm y
228.6mm

FORD TRANSIT R y L (07-13), NISSAN MARCH (12-14), MICRA (05-19), SENTRA (13-15), VERSA (13-16), RAM PROMASTER CITY (15-16)

HO431R



HO431L

BALATAS
1485ATT S714
1485 S703
TAMBOR
249.93mm

CHRYSLER GRAND VOYAGER R y L, TOWN & COUNTRY (97-01), PLYMOUTH VOYAGER (97-00)

HO434R



HO434L

BALATAS
6670 6694
TAMBOR
180.08mm

MITSUBISHI MIRAGE (83-88), MITSUBISHI LANCER (89-91), DODGE COLT (89-91) R y L

HO436R



HO436L

BALATAS
8428 951
2X64 FT001
TAMBOR
208.99mm

CHEVROLET CHEVY PICK-UP R y L (99-03)

HO445R



HO445L

BALATAS
643 1441
TAMBOR
171.95mm

FRENO DE ESTACIONAMIENTO DODGE NEON (95-05), STRATUS (02-06) R y L

HO454R



HO454L

BALATAS
1381 575
1381 607
TAMBOR
225.42mm

NISSAN TSUBAME (95-03) R y L

HO463A



HO463B

BALATAS
12X3 FT008
1666 995
TAMBOR
184.35mm

PONTIAC MATIZ (04-10), CHEVROLET MATIZ (11-15) R y L

HO492R



HO492L

BALATAS
1513 S747
TAMBOR
203.2mm

AJUSTADOR FRENO DE TAMBOR FORD FOCUS R y L (01-05)

HO493R



HO493L

BALATAS
11X81 FT024
993 1664
TAMBOR
180.59mm

AJUSTADOR FRENO DE TAMBOR FORD FIESTA (03-06), IKON (03-07) R y L

HO876R



HO876L

BALATAS
1Y16Z FT035
942 1633
TAMBOR
179.32mm

PEUGEOT 206 (03-08) NISSAN APRIO (08-10) R y L

HO879R



HO879L

BALATAS
11Y28Z FT038
1028 1694
TAMBOR
229.36mm

RENAULT KANGOO (07-12), KANGOO EXPRESS (04-19), KANGOO SPORTWAY (05-11) FIAT PALIO (04-11)

HOJ235H

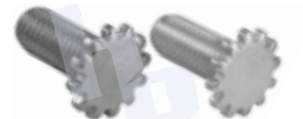

JUEGO DE AJUSTADORES FRENO DE CAMIÓN FORD F600, (71-85) R y L (2 PIEZAS)

HO019H



ESPÁTULA PARA AJUSTE DE FRENOS DODGE D100 (75-85)

Encuentra éstas y miles de aplicaciones más en:

hoautopartes.mx

TAPONES GRASERA PARA RUEDA



<p>HO259 Ø. 40.30mm</p>  <p>DATSUN SEDAN (70-83), VW CARIBE (77-87)</p>	<p>HO260A Ø. 52.90mm</p>  <p>NISSAN TSURU (87-91)</p>	<p>HO260B Ø. 52.17mm</p>  <p>NISSAN TSURU (92-17)</p>	<p>HO261 Ø. 50.00mm</p>  <p>DATSUN PICK-UP (70-83), NISSAN ICHI-VAN (88-94)</p>
<p>HO261B Ø. 59.00mm</p>  <p>NISSAN SENTRA (07-11)</p>	<p>HO262 Ø. 46.00mm</p>  <p>DODGE D100 (75-85), D150 (77-93), DODGE DART (84-88), CHRYSLER SPIRIT (90-90)</p>	<p>HO262T Ø. 53.00mm</p>  <p>HYUNDAI H100 (04-05)</p>	<p>HO263 Ø. 45.90mm</p>  <p>DODGE D300 (75-80), D350 (81-93)</p>
<p>HO264 Ø. 45.90mm</p>  <p>FORD AUTO (81-94)</p>	<p>HO264T Ø. ext. 66.20mm</p>  <p>CHRYSLER INTREPID (95-01)</p>	<p>HO265 Ø. 50.00mm</p>  <p>FORD PICK-UP (76-96) TOYOTA HILUX (79-00)</p>	<p>HO265T Ø. 75.00mm</p>  <p>FORD F350 SUPER DUTY (02-05)</p>
<p>HO266 Ø. 63.60mm</p>  <p>FORD F350 (87-96)</p>	<p>HO266T Ø. ext. 64.00 mm</p>  <p>FORD GRAND MARQUIS (95-01)</p>	<p>HO267 Ø. 63.00mm</p>  <p>CHEVROLET C35 (87-90)</p>	<p>HO267A Ø. 53.03mm</p>  <p>CHEVROLET C15 (82-88) C1500 (88-96)</p>
<p>HO269T Ø. ext. 48.00mm</p>  <p>HYUNDAI VERNA (04-06)</p>	<p>HO341 Ø. 40.30mm</p>  <p>VW SEDAN (92-04) (PERFORADO)</p>	<p>HO349 Ø. 40.30mm</p>  <p>CHEVROLET CHEVY MONZA (03)</p>	<p>HO384 Ø. 51.16mm</p>  <p>DODGE STRATUS (98-03)</p>

HO389 Ø. 52.40mm

**MARCH (12-13), MICRA (05-07),
MICRA (15-19)**

HO390 Ø. 52.30mm

DODGE ATOS (01-12)

HO390A Ø. 100.00mm

**TOYOTA LAND CRUISER
(00-09)**

HO392 Ø. 51.80mm

FIAT PALIO (04-11)

HO392A Ø. 48.00mm

TOYOTA AVANZA (12-15)

HO393B Ø. 52.40mm

CHEVROLET AVEO (10-17)

HO393C Ø. 55.30mm

RENAULT SANDERO (12-15)

HO393J Ø. 30.00mm

**FORD FIESTA (03-05), KA
(01-08) TORNILLO ROSCA
IZQUIERDA**

HO461 Ø. 53.00mm

**CHEVROLET EXPRESS1500
(96-02)**

HO461A Ø. 63.60mm

**CHEVROLET EXPRESS
3500 (96-02)**

HO498 Ø. 47.00mm

**PONTIAC MATIZ (04-10),
DAEWOO TICO (93-98)**

HO904A Ø. 40.50mm

TOYOTA COROLLA (95-05)

HO905A Ø. 37.90mm

**CHEVROLET GEO
TRACKER (92-97)**

HO906A

**CHEVROLET CORSA
(99-08)**

HO907A

HYUNDAI i10 (07-14)

HO908A Ø. 66.30mm

VW VOLKBUS (15-17)

HO909A Ø. 78.70mm

VW VOLKBUS (08-12)

**Encuentra éstas y miles de
aplicaciones más en:**

hoautopartes.mx

SEGUROS PARA CUBIERTA



HO078



VOLKSWAGEN SEDAN (77-94)

HO145

RUEDA DE VW
Ø int. 19.00mm
COMBI
Ø int. 22.20mm

HO081A



DINA 521, DODGE D-600 (PATON)

Ø. int. 67.45mm

HO082



CHEVROLET C30 (75-81), C35 MICROBUS

Ø. int. 50.80mm

HO104



DINA 861

Ø. int. 82.50mm

HO125



FORD F350 (2137)





















Ø. int. 51.20mm

HO135



FORD F200 (86-91)

Ø. int. 46.00mm

HO134A MERCEDES BENZ MICROBUS, CHEVROLET C35 (90-96) 	HO155 CORONA P/ DODGE D150 (77-93), FORD PICK-UP (65-73) 	HO156 CORONA DODGE, FORD MAVERICK (70-77), AMERICAN RAMBLER (69) 
HO156A CORONA P/ DODGE DART (82), FORD TOPAZ (84-96), NISSAN TSURU (84-87), TSURU (87-91), TSURU (92-17) 	HO156B CORONA P/ NISSAN D21 (91-07) 	HO167 DODGE D300 (75-80) 
HO176 CORONA VW CARIBE (77-87) 	HO230 ARANDELA CHICA PARA ARAÑAS DE CHEVROLET C15 (82-88) 	HO280 TUERCA PLANA P/ NISSAN 720 PICK-UP (80-86), DATSUN SEDAN AUTO (72-86) 
HO281 TUERCA PLANA PARA VW CARIBE (82-87), CORSAR (84-88), GOLF, JETTA, POINTER (89-91) 	HO281A TUERCA PLANA FORD (82-94) 	HO281T TUERCA ESPIGA FORD MUSTANG (94-05), LINCOLN TOWN CAR (98-05), FORD GRAND MARQUIS (92-04) 
HO282 TUERCA PLANA P/ CHRYSLER SHADOW (89-94), SPIRIT (90-94), DODGE D100 (75-85), FORD E150 ECONOLINE, E250 ECONOLINE (82-94), E350 (89-94), LOBO, TRITON (82-94) 	HO282A TUERCA PLANA DODGE DART (82), FORD FOCUS (02-03), NISSAN SENTRA (90-94), TSURU (87-91), TSURU (92-17) 	HO283 TUERCA PLANA P/ DODGE D300 (75-80) 
HO284 CASTILLO VW SEDAN (72-83) 	HO284A VW POLO (03-07) 	HO285 CASTILLO P/VW COMBI (73-90) 
HO286 CASTILLO PARA CHEVROLET C15, C10 (75-86), C1500 (91-99), S10 (82-95), S15, SUBURBAN (75-78), BLAZER (72-74), IMPALA (71-79), MALIBU (71-83) 	HO287 TUERCA CASTILLO DODGE DART (82), FORD F100 (77-83), F150, LOBO (97-03) 	HO288 CASTILLO FORD F350 (71-03) 

HO289

20H x
21.40 mm

**CASTILLO PARA
CHEVROLET C30
(75-81)**



HO289A

Ø int.
18 mm

**TUERCA ESPIGA
CHEVROLET
CAVALIER,
OLDSMOBILE
CUTLASS (97-99)**



HO289T

Ø int.
20.45 mm

**TUERCA RUEDA
TRASERA
HYUNDAI VERNA
(04-06), NISSAN
SENTRA (01-05),
MAXIMA (93-05)**



HO290

Ø int.
20 mm

**TUERCA ESPIGA
FORD TOPAZ (84-94),
VW CARIBE (82-87),
JETTA, GOLF (87-96),
FOCUS RT (01-03)**



HO291

Ø int.
22 mm

**TUERCA ESPIGA
PLANA P/ NISSAN
TSURU (84-87)**



HO292

Ø int.
22 mm

**TUERCA ESPIGA
TRASERA TIPO
CAMPANA PARA NIS-
SAN TSURU (87-91) Y
TSURU (92-17)**



HO292T

Ø int.
22.45 mm

**TUERCA RUEDA
NISSAN SENTRA
QR25 (01-05), XTRAIL
(01-05) (DELANTERA
Y TRASERA),
MURANO (03-05),
ALTIMA (01-05),
MAXIMA (95-05)**



HO293

Ø int.
17.20 mm

**TUERCA PIÑON
CHEVROLET C15 (65-
95), C10 SUBURBAN
(83-86), DODGE
D150 (77-93),
FORD F150 (65-95)**



HO294

Ø int.
20.40 mm

**TUERCA DE PIÑON
CHEVROLET C30
(75-81), DODGE
D300 (75-80), D350
(81-93), FORD F350
(65-01)**



HO294E

Ø int.
20.40 mm

**TUERCA DE PIÑON
ECONOMICA
CHEVROLET C30
(75-81), DODGE D300
(75-80), D350 (81-93),
FORD F350 (65-01)**



HO295

16H x
22.20mm

**TUERCA PIÑON
CHEVROLET
C30 (75-81),
DODGE D300
(75-80), D350 (81-
93), FORD F350
(65-01)**



HO299

**SEGURO
PARA TUERCA
FORD F350**



HO299A

Ø int.
50.00mm

**TUERCA CON
INSERTO DE
NYLON FORD
350 (65-95)**



HO299K

**CHEVROLET
C3500 HD
(99-02)**



HO299M

Ø 50.80mm
X 16H

**CHEVROLET C2500 (88-00),
C3500 (94-00), EXPRESS 2500,
EXPRESS 3500 (09-17),
GMC SAVANA 1500 (96-17),
SIERRA 2500 (99-04), SIERRA
2500 HD (01-10), SIERRA 3500
HD (02-10)**



HO319

**SEGURO INTE-
RIOR PARA MAZA
CHEVROLET
C35 (90-00)**



HO320

**SEGURO INTE-
RIOR CON
OREJAS PARA
MAZA
CHEVROLET
C35 (90-00)**



HO321

**SEGURO TRACTO
CAMION FAMSA
(88-90)**



HO378

Tuerca
31.70mm

**CORONA PARA
RUEDA DODGE
CARAVAN (84-95)**



HO388

Ø int.
16.60mm

**SEGURO RUEDA
VW SEDAN (92-04)**



HO393

**SEGURO INTERIOR
CON OREJAS PARA
MAZA DE CHEVROLET
HEAVY DUTY (99-01),
C35 (97-00)**



HO394

Ø int.
22.20mm

TUERCA DELANTERA
CHEVROLET MALIBU
(00-05) JEEP LIBERTY
(02-05)



HO395

Ø int.
19.00mm

TUERCA
DELANTERA
FORD FOCUS
(00-04)



HO396

Ø int.
20.60mm

TUERCA
DELANTERA FORD
CONTOUR,
MERCURY
MYSTIQUE (95-05)



HO397A

Ø int.
25.40mm

TUERCA MANGO
NISSAN URVAN
(02-06)



HO397B

Ø int.
16.60mm

SEGURO NISSAN
URVAN (00-05)



HO819

Ø 22.00 mm

TUERCA PARA MANGO
CON RETEN DODGE
RAM CHARGER,
D150 (88-00)



HO841

TUERCA PARA
MANGO TIPO
CAMPANA
TOYOTA AVANZA
(03-15)



HO842

CHEVROLET C1500
SUBURBAN (92-99),
COLORADO (04-09),
GMC YUKON (94-
00), GMC TAHOE
(94-00)



HO843

TUERCA PARA
MANGO FORD
TRANSIT (10-11)



HO845

TUERCA
PARA MANGO
CHEVROLET



HO848

TUERCA
PARA MANGO
VOLKSWAGEN
TRANSPORTER
(06-15)



HO849

TUERCA PARA
MANGO PEUGEOT
PARTNER (03-16)



HO850

RENAULT CLIO
(03-16), TRAFIC
(03-16)



HO851

TUERCA PARA
MANGO TOYOTA
HIACE, HILUX,
LAND CRUISER



HO912

Ø int. 39.73 mm

TUERCA PARA
CUBIERTA DE
DOBLE TRACCIÓN
SIN PERNO DODGE
D150 (77-84), FORD
F100 (77-83),
CHEVROLET K10
SUBURBAN (83-85)



HO913

Ø int. 39.65 mm

TUERCA PARA
CUBIERTA DE
DOBLE TRACCIÓN
CON PERNO
DODGE D150 (77-84),
FORD F100 (77-83),
CHEVROLET K10
SUBURBAN (83-85)



HO914

Ø int. 41.56 mm

ARANDELA PARA
DOBLE TRACCIÓN
DODGE D150 (77-84),
FORD F100 (77-83),
CHEVROLET K10
SUBURBAN (83-85)



HO922

Ø int. 21.00 mm

TUERCA
DELANTERA
DODGE ATOS (01-12),
VERNA (04-06)



HO922A

Ø int. 18.00mm

PONTIAC MATIZ
(00-07)

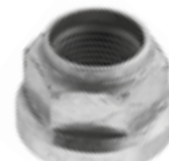

Encuentra éstas y miles de
aplicaciones más en:

hoautopartes.mx

RONDANAS PARA MANGO



HO012H Ø int. 16.60mm
Ø ext. 34.90mm

DATSUN SEDAN (78-83)

HO012HA Ø int. 27.70mm
Ø ext. 45.20mm

**NISSAN TSURU (87-17)
TRASERA**

HO013H Ø int. 21.40mm
Ø ext. 42.00mm

VAM RAMBLER (69-69)

HO027H Ø int. 19.00mm
Ø ext. 42.00mm

CHEVROLET C10 (75-86)

HO028H Ø int. 22.20mm
Ø ext. 57.15mm

CHEVROLET C30 (75-81)

HO029H Ø int. 29.30mm
Ø ext. 66.70mm

DINA 5121

HO047 Ø int. 19.80mm
Ø ext. 45.20mm

CHEVROLET AUTO

HO047T Ø int. 23.00mm
Ø ext. 38.50mm

**DODGE STRATUS (95-02), CHRYSLER
VOYAGER (96-05), NISSAN TSURU
(92-17)**

HO048 Ø int. 22.20mm
Ø ext. 51.50mm

CHEVROLET C10 (75-86)

HO048A Ø int. 19.00mm
Ø ext. 42.00mm

FORD F150 (76-98), F350

HO048B Ø int. 19.00mm
Ø ext. 42.00mm

**FORD ECONOLINE VAN E150
ECONOLINE (83-00), F200 (86-91),
F150 (76-98), LOBO CLUB WAGON**

HO079 Ø int. 16.60mm
Ø ext. 34.10mm

VW SEDAN (72-83)

HO079A Ø int. 20.00mm
Ø ext. 38.10mm

VW COMBI

HO080 Ø int. 29.30mm
Ø ext. 66.70mm

**GMC C6000 (83-90)
CHEVROLET C50 (83-90)**

HO095 Ø int. 19.80mm
Ø ext. 35.70mm

**DODGE AUTOS, CHRYSLER
SHADOW (89-94)**

HO146 Ø int. 26.00mm
Ø ext. 66.60mm

DINA DODGE

HO146A Ø int. 25.40mm
Ø ext. 53.90mm

DODGE D600

HO147 Ø int. 23.80mm
Ø ext. 45.20mm

FORD MAVERICK (70-77)

HO148 Ø int. 26.20mm
Ø ext. 50.00mm

**FORD CAMIONETA,
CHEVROLET C10 (75-86)**

HO181 Ø int. 38.10mm
Ø ext. 3 3/64"

**SEGURO KENWORTH DINA
631**

HO355 Ø int. 16.60mm
Ø ext. 34.90mm

**CHEVROLET CHEVY
MONZA (03)**

HO377 Ø int. 18.50mm
Ø ext. 43.00mm

NISSAN PICK UP (95-08)

Encuentra éstas y miles de aplicaciones más en:

hoautopartes.mx

* TODOS LOS PISTONES INCLUYEN LIGA Y SILICÓN

*Ø. = DIÁMETRO EXTERIOR
*h. = ALTURA
*CE. = CÓDIGO EQUIVALENTE

HO862



**FILTRO BOOSTER
GMC SAVANA 1500 (96-99)**

HO864



**VÁLVULA DE RETENCIÓN
TIPO UNIVERSAL**

HO864A



**VÁLVULA DOBLE DE
RETENCIÓN UNIVERSAL**

HO864B



**FORD WINDSTAR (95-03),
MERCURY MYSTIQUE
(95-00)**

HO864C



**VALVULA RETENCION
CHEVROLET CHEVY (94-12)**

HO864D



**VALVULA RETENCION
VW JETTA (96-99)**

HO871



**GOMA DE VÁLVULA DE
RETENCIÓN GRANDE
UNIVERSAL**

HO872



**GOMA DE VÁLVULA
DE RETENCIÓN CHICA
UNIVERSAL**

HO517

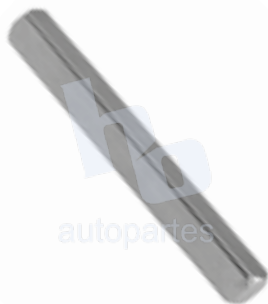

**CUÑA PARA FLECHA
7.90mm UNIVERSAL**

HO518

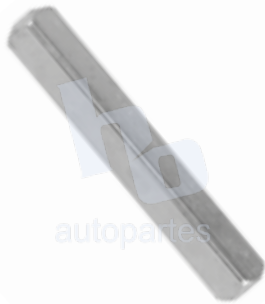

**CUÑA PARA FLECHA
9.50mm UNIVERSAL**

HO519

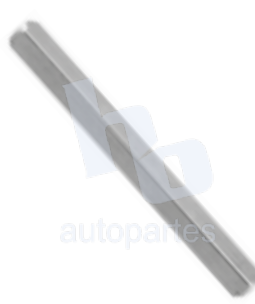

**CUÑA PARA FLECHA
6.30mm UNIVERSAL**

HO728



**CUÑA PARA FLECHA
4.70mm UNIVERSAL**

HO624



**JUNTAS PARA FLECHA
DE ASBESTO
FORD/ DODGE D150
(77-93)**

HO624A



**JUNTAS PARA FLECHA
DE ALUMINIO FORD/
DODGE D150 (77-93)**

HO625



**JUNTAS PARA FLECHA
DE ASBESTO
CHEVROLET C-30 (75-81)**

HO625A



**JUNTAS PARA FLECHA
DE ALUMINIO
CHEVROLET C-30 (75-81)**

ABRAZADERAS Y SEGUROS PARA CRUCETA



HO006H



ABRAZADERA PARA
CRUCETA # 45311 DE 6.30mm

HO007H



ABRAZADERA PARA
CRUCETA # 5-200X 521 DE 7.90mm

HO008H



ABRAZADERA PARA
CRUCETA # 5-160X 560 DE 9.50mm

HO009H



ABRAZADERA PARA
CRUCETA # 588 DE 11.10mm

HO126



ABRAZADERA PARA CRUCETA
22917 DODGE D100 (75-85).

HO126A



ABRAZADERA PARA CRUCETA
33017 DODGE D150 (77-93).

HO126B



ABRAZADERA PARA CRUCETA
30814, FORD LOBO (05-12).

HO173



SEGURO DE CRUCETA PARA DINA

HO376



JUEGO DE ABRAZADERA
P/CRUCETA SPICER # 5-160X
CHEVROLET C3500 (94-00)

CUENCAS PARA CLUTCH

HO014H



DODGE CAMION D-600 VALIANT (77-82)

HO014HA



DODGE CAMIONETA D-100 (75-85), D-150 (77-93), D-300 (75-80)

HO014HB



FORD FORD MAVERICK (70-77)

HO014HC



FORD F-150 (76-98)

HO023H



FORD FALCON (60-70)

MEDIDA:
Ø int. 19 mm

HO024H



FORD CAMIONETA F-150 (76-98), F-200 (86-91), F-350 (73-96)

MEDIDA:
Ø int. 25 mm

HO044H



AMERICAN VAM RAMBLER (69), PLYMOUTH VALIANT (73-82), TIPO VASO

HO045H



CHEVROLET C-15 (82-88), MALIBU (75-83)

PARTES PARA CLUTCH



HO031



RONDANA PARA CLUTCH 3/8"
UNIVERSAL

HO132



SEGURO PARA TEMPLADOR DODGE
D100 (75-85)

HO164



SEGURO CHICOTE DE CLUTCH PARA
VW COMBI

HO193A

DE 1/2"



HORQUILLA PARA CLUTCH
ROTOCHAMBER

HO467

CHICO
Ø 18.04 mm
h. 19.70 mm



BUJE CLUTCH CHRYSLER, DODGE
UNIVERSAL

HO468

GRANDE
Ø 25.30 mm
h. 20.93 mm



BUJE CLUTCH CHRYSLER, DODGE
UNIVERSAL

HO473



BUJES CLUTCH FORD F-100 (77-83),
F-150, F-250, F350 (98-03)

HO486



SOPORTE DE CLUTCH FORD F-350,
SUPER DUTY F-350, F-450, F-550, (99-02)

HO594B



HORQUILLA CLUTCH
NISSAN URVAN 2.5 (02-09)

HO594T

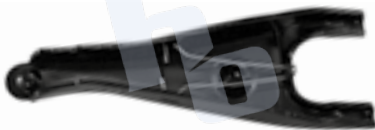

HORQUILLA CLUTCH TOYOTA HI ACE
(06-12) TACOMA (98-08) HILUX (04-12)

HO668



COLUMPIO PARA VARILLAS DE CLUTCH
DE CHEVROLET MICROBUS (90-00)

HO685



HORQUILLA PARA CLUTCH DODGE
ATOS (01-12)

HO686



HORQUILLA PARA CLUTCH NISSAN
TSURU (92-17)

HO689



HORQUILLA PARA CLUTCH CHEVROLET
CHEVY (99-12)

HO705

(PLÁSTICO)



BUJE PARA BOMBA DE CLUTCH DE
FORD PICK-UP (92-98)

HO705N

(NYLON)



BUJE PARA BOMBA DE CLUTCH DE
FORD PICK-UP (92-98)

HO755

CHICO
Ø 15.43 mm
h. 12.31 mm



BUJES CLUTCH UNIVERSAL

HO755A

GRANDE
Ø 19.74 mm
h. 20.07 mm



BUJES CLUTCH UNIVERSAL

HO756 MEDIANO
 Ø 15.29 mm
 h. 17.56 mm

BUJES CLUTCH UNIVERSAL

HO785 Ø int.14.60 mm
 h. 19.78 mm

BUJES PARA PEDAL FRENO NISSAN TSURU

HO785A Ø int. 14.47 mm
 h. 19.50 mm

BUJES CLUTCH DODGE DART (82-89)

HO814

KIT DE BUJES PARA PEDAL DE FRENO Y CLUTCH CHEVROLET C1500 (91-99), C3500 (89-95)

HO852

SOLERA P/VARILLA DE CLUTCH CHEVROLET C35 (90-00)

HO852A

BASE PARA BOMBA DE CLUTCH NISSAN URVAN 2.4 (05-12)

HO890

BUJES CLUTCH RENAULT CLIO (02-10), NISSAN PLATINA (02-10)

HO891

BUJES CLUTCH DODGE ATOS (01-12)

HO19338 DE 7/16"

HORQUILLA PARA CLUTCH DE DINA (65-73)

HO19338 DE 3/8"

HORQUILLA PARA CLUTCH DE DINA (65-73)

HO899A

PERNO PEDAL CLUTCH NISSAN PICK UP (95-08)

RS100 LARGO 36.50 cm

RESORTE PARA CLUTCH UNIVERSAL

RS200

RESORTE PARA PEDAL DE CLUTCH NISSAN NV350 URVAN (13-17)

RS312 LARGO 38.00 cm

RESORTE PARA CLUTCH DODGE D150 (77-93)

RS350 LARGO 38.00 cm

RESORTE PARA CLUTCH NISSAN URVAN (05-12)

Encuentra éstas y miles de aplicaciones más en:

hoautopartes.mx

HO077H



PERNO DE PEDAL VW SEDAN
(68-72), SEDAN (73-04)

HO077HA



PERNO EJE PEDAL CLUTCH SEDAN (68-72)
SEDAN (73-04)

HO504



MARIPOSA P/CHICOTE DE CLUTCH
VW COMBI

HO594



HORQUILLA PARA CLUTCH
VOLKSWAGEN SEDAN (82-04)

HO594A



HORQUILLA PARA CLUTCH VW
EUROVAN (00-05), GOLF JETTA (99-05)

HO660



HORQUILLA PARA CLUTCH VW
POINTER (02-05)

HO672



JUEGO DE SEGUROS PARA CHICOTE DE
DODGE DART (82), VW CARIBE (82-87)

HO672A



JUEGO DE SEGUROS PARA CHICOTE
DE VW GOLF (92-97)

HO692



BUJE PERNO PEDAL DE CLUTCH VW
SEDAN (68-72), SEDAN (82-04)

HO786

DELGADO



BUJE DE PLÁSTICO PARA HORQUILLA
VW SEDAN (68-72), SEDAN (74-03)

HO786B

GRUESO



BUJE DE PLÁSTICO PARA HORQUILLA
VW SEDAN (68-72), SEDAN (74-03)

HO786A



BUJE DE BRONCE PARA HORQUILLA
VW SEDAN (68-72), SEDAN (82-04)

HO788



BUJE MARMOLA CLUTCH VW
JETTA (92-97)

HO792



CANDELERO DE CLUTCH PARA VW
SEDAN

HO816



KIT DE GOMA PARA CHICOTE DE
CLUTCH VW JETTA A3 (93-98),
GOLF (93-99)

HO787



ABRAZADERA PARA CREMALLERA
VOLKSWAGEN ATLANTIC (84-87),
CARIBE (77-85)

Encuentra éstas y miles de
aplicaciones más en:

hoautopartes.mx

AJUSTES PARA CLUTCH

HO106

MEDIDA: 195.00 mm



DODGE CAMIONETA Y CAMIÓN
D-500, D-600 (76-82)

HO107

MEDIDA: 232.00 mm



FORD F-100 (65-83).

HO108

MEDIDA: 280.50 mm



FORD F-600 (73-79).

VARILLAS PARA CLUTCH



HO112



VARILLA EN C PARA FORD
F-100 (77-83) L. 431.80 mm

HO112A



VARILLA EN Z PARA FORD
F-100 (77-83) h. 431.80 mm

HO113



VARILLA EN C PARA FORD
F-100 (77-83) h. 482.60 mm

HO114



VARILLA EN C PARA FORD F-100
(77-83) h. 533.40 mm

HO114A



VARILLA EN C PARA FORD F-100 (77-83) h. 635.00 mm

HO491

CORTA 31.00 cm



VARILLA DE EMPUJE PARA CLUTCH
VW GOLF (85-89), JETTA (80-92), 4 VELOCIDADES 1.6L

HO492

MEDIANA 34.00 cm



VARILLA DE EMPUJE PARA CLUTCH
VW, GOLF (90-98), JETTA, (87-98), 5 VELOCIDADES 1.8L

HO492A

LARGA 36.00 cm



VARILLA DE EMPUJE PARA CLUTCH
VW JETA GOLF, DERBY (99-03), SEAT CORDOBA (03-09), IBIZA (99-03)

HO017H



autopartes

SEGUROS PARA PORTACOLLARÍN
VOLKSWAGEN SEDAN (68-72)

HO018H



autopartes

SEGUROS PARA PORTACOLLARÍN
DINA 531

HO018HA



autopartes

JUEGO DE SEGUROS PARA DODGE
D100 (75-85)

HO018HB



autopartes

JUEGO DE SEGUROS PARACOLLARÍN
DE NISSAN TSURU (84-87)
TSURU (88-91), TSURU (92-17)

HO018HC



autopartes

SEGURO PORTACOLLARÍN
VOLKSWAGEN SEDAN (68-72)

HO018HD



autopartes

SEGURO PARA HORQUILLA DE CLUTCH
VOLKSWAGEN JETTA A4 (99-10), GOLF
(99-10), DERBY (06-09), BEETLE (98-10),
EUROVAN (02-09)

HO018HP

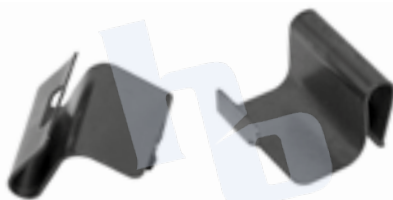

autopartes

JUEGO DE SEGUROS PARA
COLLARIN DE CLUTCH NISSAN
NP300 (12-20), URVAN (12-20)

HO345

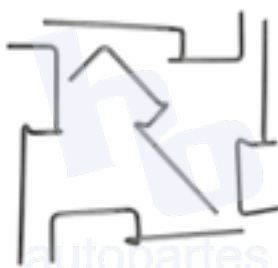

autopartes

SEGURO COLLARIN BUICK CENTURY
(87-94), CHEVROLET CAVALIER (90-92),
OLDSMOBILE CUTLASS (87-94).

HO386

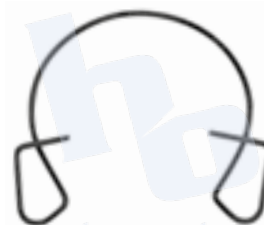

autopartes

SEGURO COLLARÍN 614108
CHEVROLET 4 Y 6 CILINDROS,
PONTIAC GRAND AM (99-02) U.S.A.

HO387



autopartes

JUEGO DE SEGUROS COLLARÍN
VOLKSWAGEN SEDAN (82-04)

HO399



autopartes

SEGURO COLLARÍN
HYUNDAI ATOS (01-12)

Encuentra
éstas y miles
de aplicaciones
más en:

hoautopartes.mx

BUJES Y BALEROS PARA FLECHA PILOTO



HO218

MEDIDAS
 Ø Int. 15 mm
 Ø Ext. 28 mm
 h. 19 mm



CHEVROLET C15 (82-88)
(BRONCE)

HO219

MEDIDAS
 Ø Int. 16 mm
 Ø Ext. 21 mm
 h. 18 mm



DATSUN SEDAN (72-83), NISSAN
PICKUP (95-08), PICKUP (05-12)
(BRONCE)

HO221

MEDIDAS
 Ø Int. 17 mm
 Ø Ext. 35 mm
 h. 13 mm



FORD 289, 251, 250, FORD FAIR-
MONT (78-83) (BRONCE)

HO222

MEDIDAS
 Ø Int. 17 mm
 Ø Ext. 47 mm
 h. 13 mm



FORD E-250 ECONOLINE
(92-97)

HO223

MEDIDAS
 Ø Int. 16 mm
 Ø Ext. 35 mm
 h. 13 mm



FORD 351 (BRONCE)

HO224

MEDIDAS
 Ø Int. 17 mm
 Ø Ext. 40 mm
 h. 13 mm



FORD 240, 300

HO226

MEDIDAS
 Ø Int. 19 mm
 Ø Ext. 25 mm
 h. 19 mm



VAM RAMBLER (69)

HO358

MEDIDAS
 Ø Int. 15 mm
 Ø Ext. 21 mm
 h. 19 mm



CHEVROLET BLAZER (98-04),
S10 (95-03)

HO750



FORD 302

HO750A



DODGE D150 (77-93)

HO750B



CHEVROLET C15 (82-88)

HO750C



AUDI A3 (01-09), A4 (99-05),
CHEVROLET ASTRA (01-08),
CORSA (02-08), VECTRA (03-07),
ZAFIRA (02-06), FORD CONTOUR
(95-00), MONDEO (05-07), RANGER
(95-98), MERCURY MYSTIQUE
(98-00)

HO750D



VOLKSWAG JETTA, (96-99),
GOLF (93-99), BEETLE (00-
15), POINTER (02-09)

HO750E



DODGE DAKOTA (97-04)

HO750F



FORD F-350 SUPER DUTY
(99-00)

HO750G



FORD F-350 SUPER DUTY
(99-00)

HOKC100

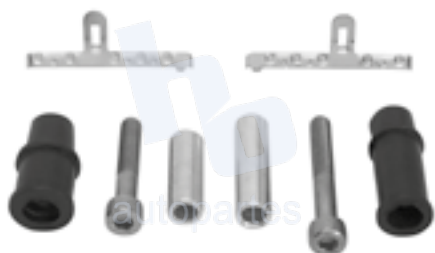

KIT DE CALIPER RUEDA DELANTERA

SEAT TOLEDO (02-04) 7183 D569, **VOLKSWAGEN ATLANTIC (84-87)** 7183 D569, 7183 D280, 7209 D280 **CARIBE (84-87)** 7183 D569, 7183 D280, 7209 D280, **CORSAR (84-88)** 7183 D569, 7183 D280, 7209 D280, **DERBY (95-98)**, 7183 D569, **GOLF (87-96)** 7183 D280, 7209 D280, 7183 D569, **JETTA (87-95)** 7183 D280, 7209 D280, 7183 D569, **JETTA ATLANTA (93-95)** 7183 D569. **SEAT LEON (02-04), TOLEDO (02-06)**

HOKC101



KIT DE CALIPER RUEDA DELANTERA VOLKSWAGEN ATLANTIC (84-97) 7031 D96, CARIBE (77-85) 7031 D96.

HOKC102



KIT DE CALIPER RUEDA TRASERA

PEUGEOT 208 (14-15) 7234 D340, **PEUGEOT 306 (02-04), 307 (03-10), 405 (97-99), AUDI A4 (97-05), A6 (00-03), A8 (97-00), AUDI ALLROAD QUATTRO (01-03), SEAT ALTEA (06-15), VW BEETLE (99-07), BORA (05-10), CABRIOLET (85-93), SEAT CORDOBA (03-09)** 7335 D340, **VW DERBY (02-05), RENAULT FLUENCE (11-14), VW GOLF (92-99)** 7234 D340, **GOLF (97-05), SEAT IBIZA (03-16)** 7335 D340, **VW JETTA (93-97)** 7234 D340, **JETTA (97-05), SEAT LEON (01-07), RENAULT MEGANE (06-09)** 7335 D340, **RENAULT MEGANE (04-09), VOLKSWAGEN PASSAT (91-96)** 7234 D340, **VW PASSAT (96-05), POLO (03-07), AUDI S4 (00-01), S6 (01-02)** 7335 D340, **RENAULT SCENIC (01-04)** 7234 D340, **RENAULT SCENIC (01-04)** 7335 D340, **SCENIC II (07-08)** 7234 D340, **SEAT TOLEDO (01-06)** 7234 D340, 7335 D340, **AUDI TT (00-06)** 7335 D340

HOKC103



KIT DE CALIPER RUEDA DELANTERA

AUDI 200 (89-91), 4000 (80-84), 5000 (85-88), 4000 QUATTRO (84-87), A4 (01-02), A4 CABRIOLET (85-93), A6 (01-02) 7306 D419, **COUPE (85-87)** 7177 D227, **S4 (93-94)** 7306 D419, **SEAT CORDOBA (03-09), IBIZA (01-07)** 7578 D704, 7177 D227, **VOLKSWAGEN CABRIOLET (94-99)** 7177 D227, **DERBY (97-09)** 7177 D227, 7578 D704, **GOLF (92-05)** 7177 D227, 7177 D227, 7578 D704, **GOLF GTI VR6 (94-98)** 7177 D227, **JETTA (96-05)** 7143 D227, 7177 D227, 7578 D704, **JETTA GLX (89-96)** 7177 D227, **PASSAT (91-93)** 7143 D227, **PASSAT VR6 (96-98), POINTER TRUCK (99-01), SIROCCO (87-90)** 7177 D227, **VAN (03-05)** 7578 D704

HOKC104

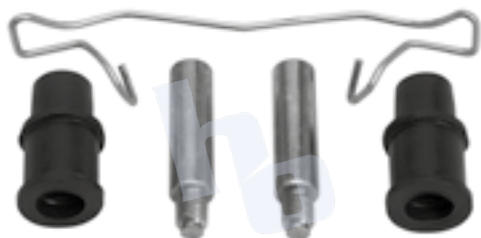

KIT DE CALIPER RUEDA DELANTERA

AUDI A3 (99-09), A4 (96-01) 7710 D687, 7434 D555, **A6 (96-00), A8 (97-00), QUATTRO (97-00)** 7434 D555, **AUDI S3 (00-01), AUDI TT (00-02)** 7710 D687, **VOLKSWAGEN BEETLE (99-05)** 7434 D687, **GOLF (95-99)** 7434 D555, 7710 D687, **GOLF VR6 (97-01)** 7434 D555, **JETTA (95-05)** 7434 D555, 7434 D687, **JETTA A4 (99-02)** 7434 D687, **PASSAT (96-05)** 7434 D687, 7434 D555.

HOKC105



KIT DE CALIPER RUEDA DELANTERA
DODGE RAM 700 (15-18) 7W04 F498, **RAM PROMASTER RAPID (17-19)** 9135 D1906, **DODGE VISION (15-19)** 7W04 F498, 9135 D1906, **FIAT ESTRADA (07-14)** 7W04 F498, **POINTER TRUCK (99-10)** 8284 D1173
KIT DE CALIPER RUEDA TRASERA
VOLKSWAGEN POINTER (99-07) 77X7 D350

HOKC106

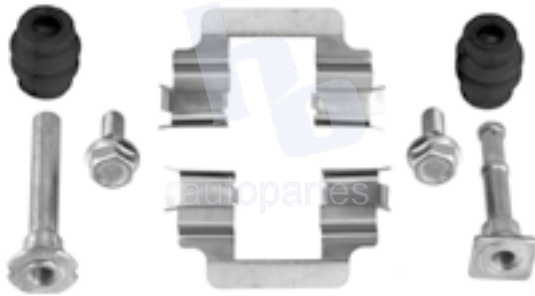

KIT DE CALIPER RUEDA DELANTERA
SEAT CORDOBA (03-09) 8555 D1437, 7Y08 F221,
KIT DE CALIPER RUEDA TRASERA
IBIZA (03-08) 8555 D1437, 7Y08 F221,
VOLKSWAGEN POLO (03-07) 8555 D1437, 7Y08 F221.

HOKC107



KIT DE CALIPER RUEDA DELANTERA
AUDI Q7 (07-15) 7878 D1014, **PORSCHE CAYENNE (03-09)**
 7911 D1007, **VW TOUAREG C-ROTOR 330mm y**
350mm (09-12) 7911 D1007.

HOKC108

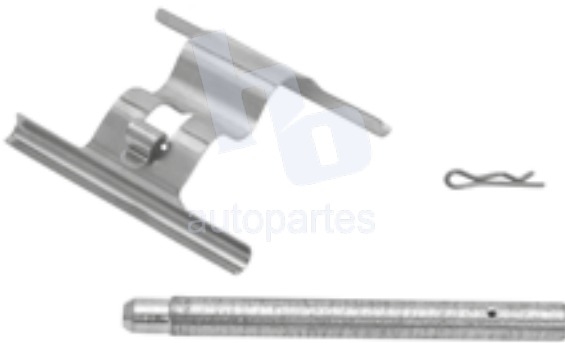

KIT DE CALIPER RUEDA TRASERA
AUDI Q7 TDI (08-10), PORSCHE CAYENNE (03-09),
VOLKSWAGEN TOUAREG (05-08) 7908 D978,

HOKC109

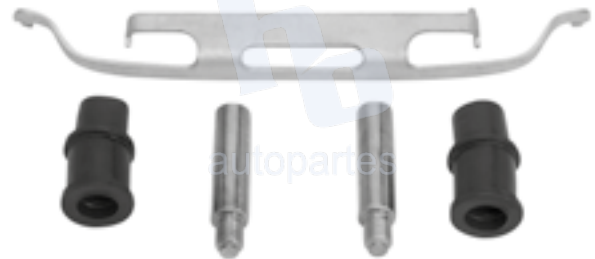

KIT DE CALIPER RUEDA DELANTERA
VOLKSWAGEN GOLF GTI (93-99) 7561 D682,

HOKC111



KIT DE CALIPER RUEDA DELANTERA
VOLKSWAGEN EUROVAN (00-03) 7X66 F181,

HOKC112



KIT DE CALIPER RUEDA DELANTERA
AUDI A3 (08-13), SEAT ALTEA (06-15), VOLKSWAGEN
BETLE (11-19), BORA (05-10) 8212 D1107, **EOS (08-16)**
 8212 D1107, 8212 D1319, **GOLF (05-11)** 8760 D1107,
JETTA (07-18) 8212 D1107, **PASSAT (15-16)** 8486 D1575,
TIGUAN (09-18) 8486 D1375

HOKC113

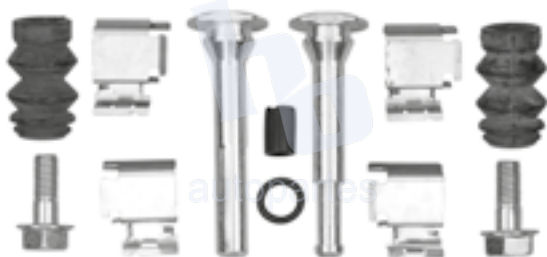

KIT DE CALIPER RUEDA DELANTERA
VOLKSWAGEN BEETLE (00-15), EOS (11-16) 8656 D1456,
KIT DE CALIPER RUEDA TRASERA
GOLF (10-12), JETTA (11-14) 8656 D1456,

HOKC114



KIT DE CALIPER RUEDA TRASERA
AUDI A3 (04-10) 8213 D1108, 8213 D1348, **A4 (06-09)** 8213 D1108, **A6 (04-10)** 8213 D1348, 8213 D1108, **Q3 (15-17)** 8213 D1348, **AUDI TT (03-14)** 8213 D1348, 8213 D1108, **AUDI TT RS (09-14)**, **AUDI TTS QUATTRO (09-13)** 8213 D1108, **FIAT FREEMONT (10-11)** 8213 D1348, **SEAT ALTEA (05-12)**, **ALTEA XL (08-15)**, **IBIZA (05-10)**, **LEON (08-16)** TOLEDO (13), **VOLKSWAGEN BEETLE (06-07)**, **BORA (05-10)**, **CC (09-12)**, **EOS (07-11)**, **GOLF (05-11)**, **GTI (15-16)**, **JETTA (06-10)** 8213 D1108, **PASSAT (05-10)** 8213 D1348, 8213 D1108, **TIGUAN (09-16)**, **VOLVO S60 (11-12)** 8213 D1348.

HOKC115



KIT DE CALIPER RUEDA DELANTERA
AUDI Q3 (16-17), AUDI QUATTRO (16-17) 9008 D1779.
KIT DE CALIPER RUEDA TRASERA
VOLKSWAGEN GOLF (15-17), GOLF ALL TRACK (16-17), GOLF SPORTWAGEN (15-17), GTI (15-17), PASSAT (15-17) 9008 D1779

HOKC116



KIT DE CALIPER RUEDA DELANTERA
AUDI A1 (18-20), **A3 (14-20)** 8849 D1633, 8989 D1760, **A3 QUATTRO (15-18)**, **Q2 (18)**, **TT QUATTRO (16-20)** 8989 D1760, **SEAT ATECA (17-18)**, **LEON (14-17)**, **VOLKSWAGEN CADDY (16-17)**, **CC (12-16)** 8849 D1633, **CROSSFOX (16-17)** E-GOLF (15-19) 8849 D1760, **GOLF (15-21)** 8849 D1633, 8849 D1760, **GOLF ALL TRACK (17-19)** 8849 D1760, **GOLF R (15-18)** 8849 D1633, **GOLF SPORTWAGEN (15-19)** 8849 D1760, **GTI (15-18)** 8849 D1633, 8849 D1760, **JETTA (19-21)** 8849 D1760, **TIGUAN (18-20)** 8849 D1633, **TAOS (21-22)** 8849 D1760

HOKC117



KIT DE CALIPER RUEDA TRASERA
AUDI A3 (16-20), AUDI TT QUATTRO (16-20) 8990 D1761, HONDA ACCORD (18-21), INSIGHT (18-21) 9106 D2102, SEAT LEON (16-17), VOLKSWAGEN E-GOLF (15-19), GOLF (15-20), VOLKSWAGEN JETTA (19-21), TIGUAN (18-20) 8990 D1761.

HOKC118



KIT DE CALIPER RUEDA DELANTERA
VOLKSWAGEN POLO (13-21), VENTO (14-21) 9006 D1776.

HOKC119



KIT DE CALIPER RUEDA DELANTERA VW SAVEIRO (12-20) 8868 D1641, GOL (12-20) 8868 D1641, UP! (16-18) 8868 D1641

HOKC200C



KIT DE CALIPER RUEDA DELANTERA BUICK CENTURY (78-96), BUICK REGAL (78-87), BUICK RIVIERA (79-85) 7070A D154, C10 (75-86), C20 (76-86), C30 (75-81) 728 D52, C3500 (94-96) 7084 D153, CAPRICE (76-82) 728 D52, CHEVELLE (64-73), IMPALA (71-77), MALIBU (78-81), MONTECARLO (78-81), NOVA (73-88), S10 (90-92) 7070A D154, JEEP CHEROKEE (80-86), JEEP WAGONEER (80-86) 728 D52, GMC JIMMY (82-95) 7070A D154
KIT DE CALIPER RUEDA TRASERA SUZUKI JIMNY (82-94) 7070A D154.

HOKC200L

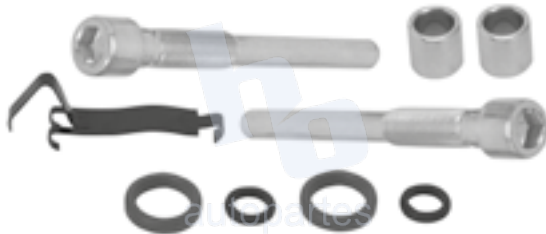

KIT DE CALIPER RUEDA DELANTERA BUICK CENTURY (78-91) 728 D52, 7070 D154, BUICK REGAL (78-81), BUICK RIVIERA (79-81) 7070 D154, CHEVROLET ASTRO (92-97), C10 (75-86), C1500 (82-88), C30 (75-81) 728 D52.

HOKC201



KIT DE CALIPER RUEDA DELANTERA CHEVROLET ASTRO (89-02) 7259 D369, CHEVROLET C15 (82-88), C1500 (91-99) 7260 D370, C2500 (88-00) 7260 D369, C3500 (94-00), EXPRESS 2500 (96-02), EXPRESS 3500 (96-02), TAHOE (95-00) 7260 D370, CADILLAC DEVILLE (93-99), ESCALADE (99-00), CHEVROLET EXPRESS 1500 (96-02), DODGE RAM 1500 (94-97), CHEVROLET S10 BLAZER (83-94), GMC SAVANA 1500 (00-03) 7259 D369.

HOKC202



KIT DE CALIPER RUEDA TRASERA CHEVROLET CAMARO (89-97), CORVETTE (88-96), PONTIAC FIREBIRD (82-97) 7301 D413.

HOKC202A



KIT DE CALIPER RUEDA DELANTERA CADILLAC CATERA (97-01) 7588 D720
KIT DE CALIPER RUEDA TRASERA SATURN SC (91-92), SATURN SL (97-02) 7595 D728.

HOKC202B



KIT DE CALIPER RUEDA TRASERA
CADILLAC CATERA (97-01) 7582 D709,
SATURN SC (91-92), SATURN SL (97-02) 7387 D714

HOKC203



KIT DE CALIPER RUEDA DELANTERA
CHEVROLET CAVALIER (92-05) 7554 D673, OLDSMOBILE
SILHOUETTE (96-98) 7385 D506, SUNFIRE (91-98) 7554 D673
KIT DE CALIPER RUEDA TRASERA
PONTIAC GRAND AM (95-05) 7554 D673.

HOKC204

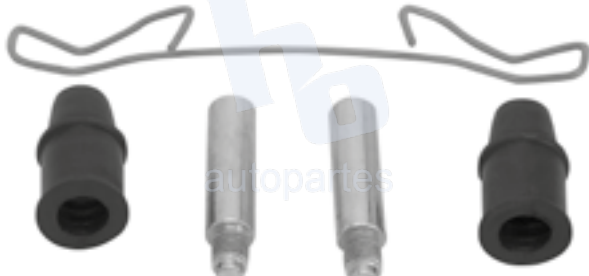

KIT DE CALIPER RUEDA DELANTERA
CHEVROLET CHEVY (94-12), CHEVY MONZA (03) CHEVY
PICKUP (99-03) 7563 D688.

HOKC205



KIT DE CALIPER RUEDA DELANTERA
CHEVROLET AVALANCHE 1500 (02-09), EXPRESS 1500
(02-17), EXPRESS 2500 (15-17), EXPRESS 3500 (15-17),
EXPRESS 4500 (13-15), GMC SAVANA 2500 (15-17),
SILVERADO 1500 (01-06), SILVERADO 2500 (99-06),
SILVERADO 3500 (99-06), SONORA (01-05), SUBURBAN
2500 (00-06), GMC YUKON XL 2500 (00-13) 7652 D784

HOKC206



KIT DE CALIPER RUEDA DELANTERA
AM GENERAL HUMMER H2 (04-07) 7653 D785,
KIT DE CALIPER RUEDA TRASERA
CHEVROLET SILVERADO 1500 (02-06),
SUBURBAN 2500 (00-06), TAHOE (02-06) 7653 D785.
KIT DE CALIPER RUEDA DELANTERA Y TRASERA
CADILLAC ESCALADE (02-07), CHEVROLET AVALANCHE
1500 (02-06), SILVERADO 1500 (99-05), 2500 (99-05), GMC
SIERRA 1500 (02-06), 2500 (99-04) 2500 HD (01-10), 3500
(02-06), YUKON (99-06), 7653 D785.

HOKC207



KIT DE CALIPER RUEDA TRASERA
CHEVROLET BLAZER (98-04), S10 (98-04),
OLDSMOBILE BRAVADA (97-01) 7593 D726.

HOKC208



KIT DE CALIPER RUEDA DELANTERA
CHEVROLET GEO TRACKER 2 Y 4 PUERTAS (96-01),
SUZUKI SIDEKICK (92-97) 7435 D556.

HOKC209



KIT DE CALIPER RUEDA DELANTERA
BUICK CENTURY (97-01), CADILLAC EL DORADO (97-02),
CHEVROLET IMPALA (00-02) 7693 D818, VENTURE
(97-01), OLDSMOBILE SILHOUETTE (97-04) 7574 D699,
PONTIAC GRAND PRIX (97-03) 7693 D818,
MONTANA (01-02) 7574 D699.

HOKC210



KIT DE CALIPER RUEDA DELANTERA
CHEVROLET MALIBU (97-06),
OLDSMOBILE CUTLASS (97-99) 7594 D727,
PONTIAC GRAND AM (99-02) 7620 D752.

HOKC211

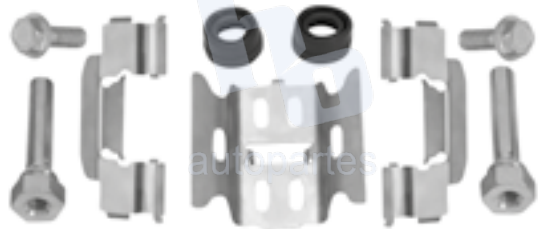

KIT DE CALIPER RUEDA TRASERA
CHEVROLET BLAZER (97-05), BRAVADA (97-01), GMC JIMMY
(97-05), SONOMA (97-04), ISUZU HOMBRE (97-00) 7596 D729

HOKC212



KIT DE CALIPER RUEDA TRASERA
CADILLAC ESCALADE (02-05), CHEVROLET AVALANCHE
1500 (02-07), SONORA (01-06), SUBURBAN 1500 (00-04)
7707 D834

HOKC213



KIT DE CALIPER RUEDA DELANTERA
CHEVROLET VENTURE (02-04) 7720 D844,
KIT DE CALIPER RUEDA TRASERA
OLDSMOBILE SILHOUETTE (01-02), PONTIAC
AZTEK (01-05), PONTIAC MONTANA (02-04) 7720 D844.

HOKC213A

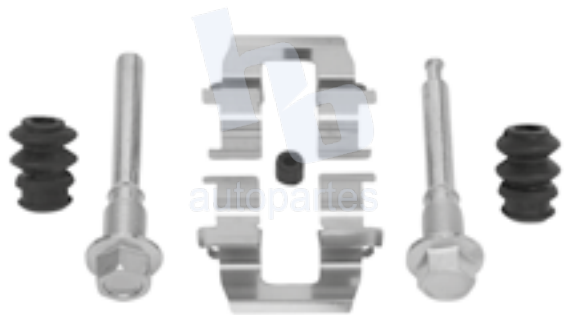

KIT DE CALIPER RUEDA TRASERA
CHEVROLET MONTE CARLO (02-06), VENTURE (02-04),
OLDSMOBILE SILHOUETTE (01-04), PONTIAC AZTEK
(01-04), MONTANA (01-04) 7387 D814.

HOKC214



KIT DE CALIPER RUEDA DELANTERA
CHEVROLET TRAIL BLAZER (02-05), GMC ENVOY (02-05)
7759 D882.

HOKC214A



KIT DE CALIPER RUEDA TRASERA
BUICK ENCLAVE (08-14), CHEVROLET TRAIL BLAZER (02-05)
TRAVERSE (09-13), GMC ACADIA (07-15), ENVOY (02-05)
7760 D883.

HOKC215

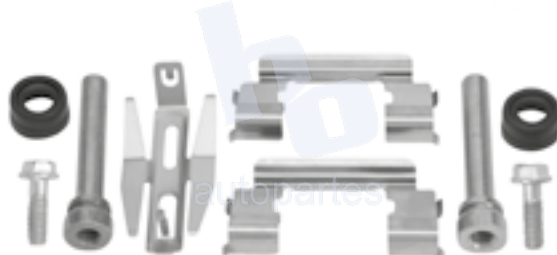

KIT DE CALIPER RUEDA DELANTERA
CHEVROLET CAMARO (98-02), PONTIAC CORVETTE (09-
12), FIREBIRD (98-02) 7618 D749.

HOKC216

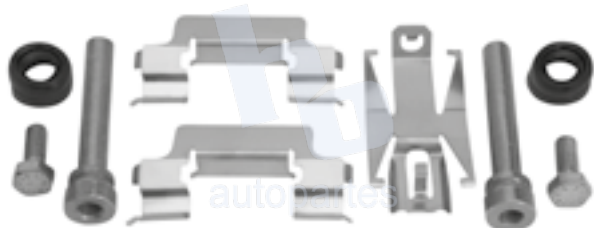

KIT DE CALIPER RUEDA TRASERA
CHEVROLET CAMARO (98-02), PONTIAC FIREBIRD (98-02),
PONTIAC TRANS AM (98-02) 7619 D750.

HOKC217



KIT DE CALIPER RUEDA DELANTERA Y TRASERA
CHEVROLET C60 KODIAK (90-96) 7808 D225, GMC C6000
(82-99), CHEVROLET C70 (83-90) 7142 D225

HOKC218



KIT DE CALIPER RUEDA TRASERA
BUICK REGAL (96-99), CADILLAC DEVILLE (96-05),
CHEVROLET LUMINA (94-01) 7387 D714.

HOKC219

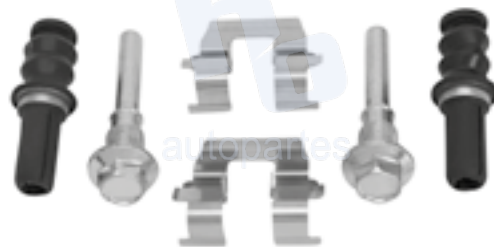

KIT DE CALIPER RUEDA TRASERA
CHEVROLET IMPALA (02-05),
PONTIAC GRAND AM (99-03), GRAND PRIX (97-03)
7387 D698.

HOKC220

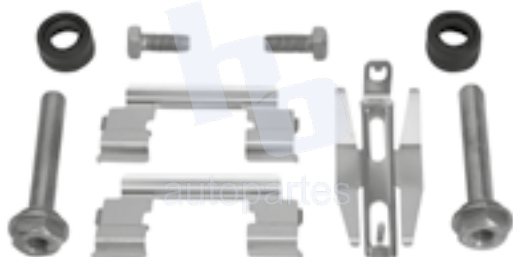

KIT DE CALIPER RUEDA DELANTERA
CADILLAC XLR (04-09),
CHEVROLET CORVETTE (97-13) 7599 D731.

HOKC221

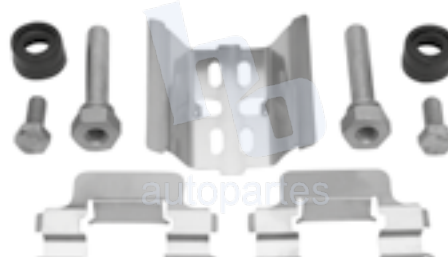

KIT DE CALIPER RUEDA TRASERA
CADILLAC STS (05-10), CADILLAC XLR (04-09),
CHEVROLET CORVETTE (97-06) 7600 D732.

HOKC222

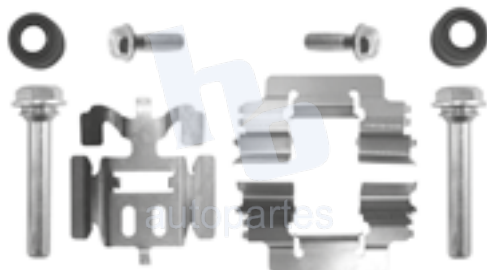

KIT DE CALIPER RUEDA TRASERA
CADILLAC DEVILLE (01-04), CHEVROLET AVALANCHE
1500 (02-07), AVALANCHE 2500 (01-07), SILVERADO 1500
(99-06), GMC SIERRA 1500 (99-06) 7700 D792.

HOKC223

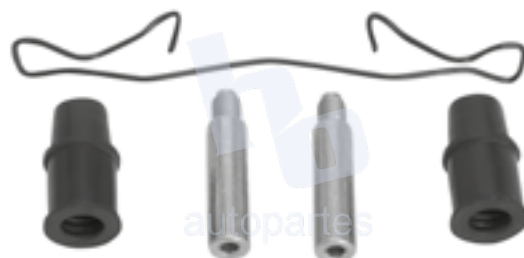

KIT DE CALIPER RUEDA DELANTERA
CHEVROLET ASTRA ABS (00-07), MERIVA (07-08),
ZAFIRA (02-06) 768X F185.

HOKC224

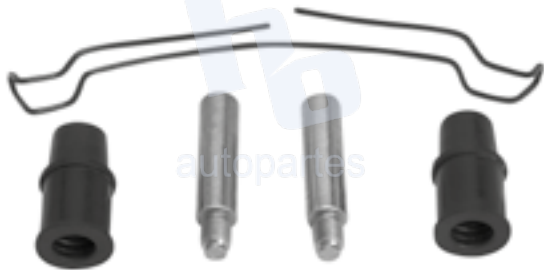

KIT DE CALIPER RUEDA DELANTERA
CHEVROLET ASTRA (00-07) 766X F186, 8741 D1532.

HOKC225

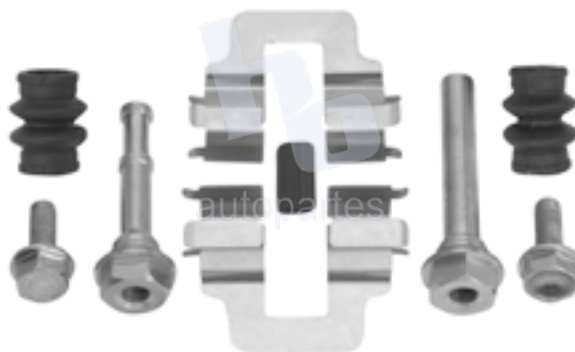

KIT DE CALIPER RUEDA TRASERA
CHEVROLET ASTRA (02-08), MERIVA (07-08)
CHEVROLET ZAFIRA COMFORT (02) 778X F202.

HOKC226



KIT DE CALIPER RUEDA DELANTERA
CHEVROLET EQUINOX (04-07),
PONTIAC TORRENT (06-08) 7794 D913.

HOKC227

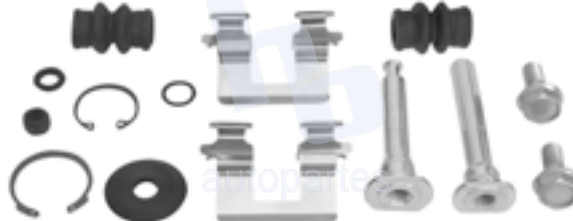

KIT DE CALIPER RUEDA TRASERA
CHEVROLET UPLANDER (05-07),
PONTIAC MONTANA (05-09) 7999 D1093.

HOKC227A

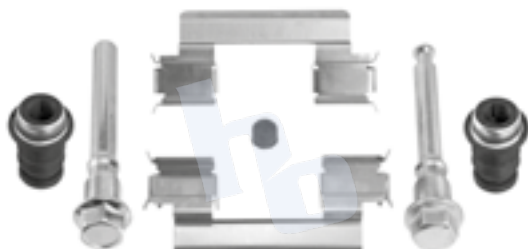

KIT DE CALIPER RUEDA DELANTERA
CHEVROLET CAPTIVA SPORT (11-12) 7980 D1075,
IMPALA (02-05), MONTE CARLO (02-05), CADILLAC
DEVILLE (01-05), BUICK LESABRE (99-05), BUICK PARK
AVENUE (00-05) 7981 D1076, PONTIAC MONTANA (05-09),
CHEVROLET UPLANDER (05-07) 7980 D1075

HOKC228

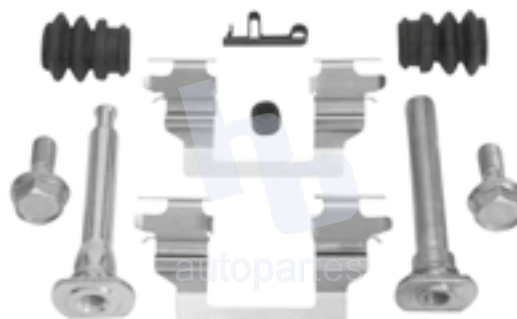

KIT DE CALIPER RUEDA DELANTERA
CHEVROLET COBALT (05-08) 7932 D1028, HHR (06-11),
MALIBU (04-12), PONTIAC G5 (07-10) 7932 D1028, 8270
D1160, G6 (01-06) 8270 D1160

HOKC229

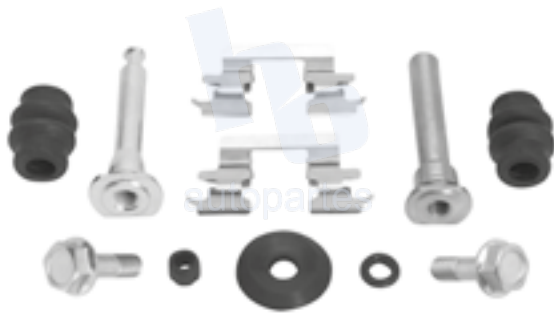

KIT DE CALIPER RUEDA TRASERA
CHEVROLET COBALT (05-08), HHR (06-11),
PONTIAC G5 (07-09), G6 (07-09) 7937 D1033,
MALIBU (04-11) 8474 D1364.

HOKC230



KIT DE CALIPER RUEDA DELANTERA
CHEVROLET COLORADO (04-07), ISUZU DMAX 2WD
(05-07), DMAX 4WD (05-07) 7943 D1039.

HOKC231

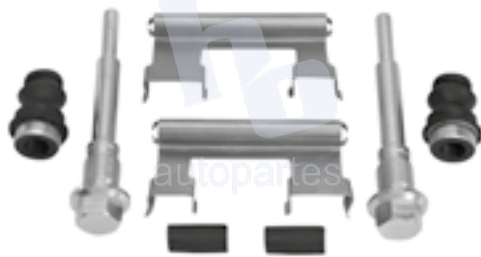

KIT DE CALIPER RUEDA DELANTERA
CHEVROLET SILVERADO 1500 (04-07), SILVERADO 3500
(01-06), GMC SIERRA 3500 CLASSIC (07) 7788 D909

HOKC232

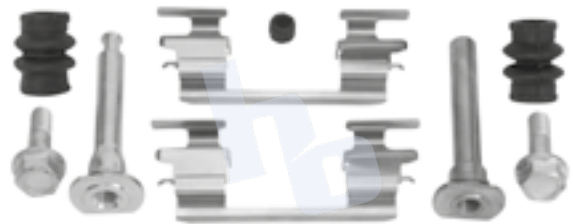

KIT DE CALIPER RUEDA TRASERA
CHEVROLET AVALANCHE (07-13), AVALANCHE 1500 (03-06)
EXPRESS PASAJEROS (10-20), EXPRESS 1500 (03-14),
CADILLAC ESCALADE (03-06) 7881 D974, CHEVROLET
EXPRESS 2500 (03-17), EXPRESS 3500 (05-17), EXPRESS
4500 (09-17), GMC SAVANA 2500 (05-17), SAVANA 3500 (05-
17) 7652 D784, 7881 D974, SAVANA 1500 (09-14) 7881 D974,
CHEVROLET SONORA (01-00) 7652 D784, SUBURBAN 1500
(00-17) 7652 D784, 7881 D974, TAHOE (03-06), GMC
YUKON (03-06) 7881 D974

HOKC233



KIT DE CALIPER RUEDA DELANTERA
CHEVROLET CORSA (02-08), TORNADO (04-18) 7Y03
F209, 8290 D1176.

HOKC236

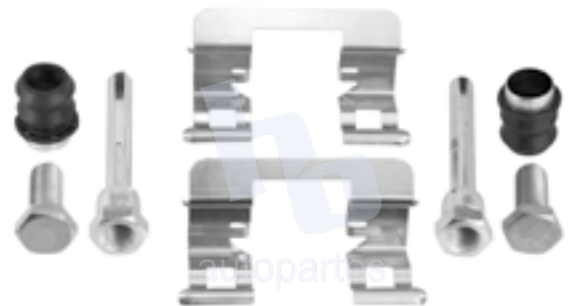

KIT DE CALIPER RUEDA DELANTERA
CADILLAC ESCALADE (02-11), CHEVROLET SILVERADO
1500 (05-17), GMC SIERRA 1500 (02-11),
GMC YUKON (07-12) 7997 D1092.
KIT DE CALIPER RUEDA TRASERA
CHEVROLET TAHOE (07-12) 7997 D1092.

HOKC237

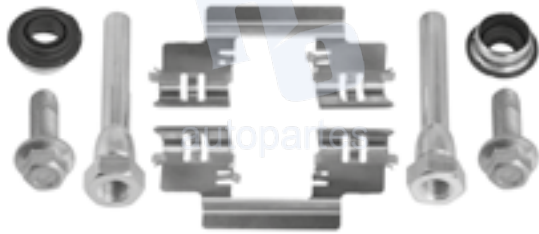

KIT DE CALIPER RUEDA TRASERA
CADILLAC ESCALADE (07-11), CHEVROLET AVALANCHE
(07-09), SIERRA 1500 (08-12), SUBURBAN (15-20),
SUBURBAN 1500 (11-14), CHEVROLET TAHOE (07-12),
GMC YUKON (07-12) 8312 D1194.

HOKC238

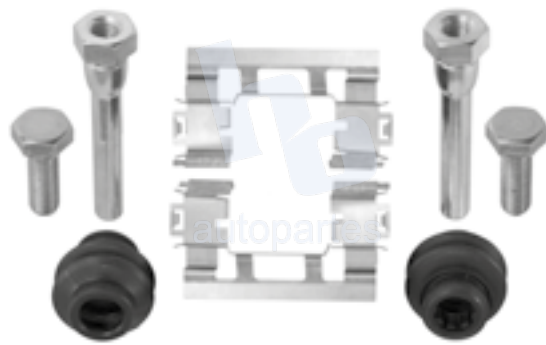

KIT DE CALIPER RUEDA DELANTERA
CHEVROLET COLORADO (06-07) 8282 D1169,
TRAIL BLAZER (02-09) 7759 D882, 8282 D1169,
GMC ACADIA (07-17), CANYON (09-11) 8282 D1169,
ENVOY (02-09) 7759 D882, TRAVERSE (09-17) 8282 D1169.

HOKC239



KIT DE CALIPER RUEDA TRASERA
BUICK ENCLAVE (08-17) 7760 D1507,
CHEVROLET TRAIL BLAZER (02-09) 7760 D883,
TRAVERSE (09-17), GMC ACADIA (13-17) 7760 D1507,
ENVOY (03-07), OLDSMOBILE BRAVADA (02-04)
7760 D883.

HOKC240

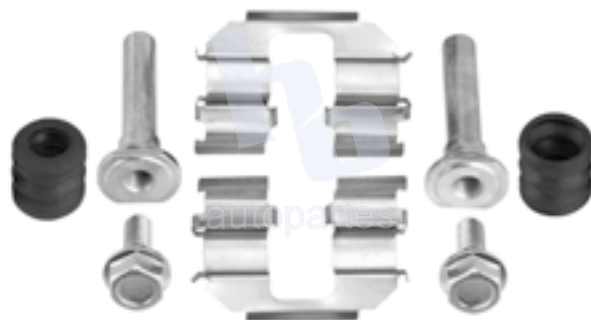

KIT DE CALIPER RUEDA DELANTERA
CHEVROLET MATIZ (11-15) 74X7 F139, 9162 D1937,
PONTIAC MATIZ (04-10) 8433 D1321.

HOKC241



KIT DE CALIPER RUEDA DELANTERA
CHEVROLET AVEO (07-17), OPTRA (06-08), SPARK (13-15)
PONTIAC G3 (07-09), SUZUKI FORENZA (04-06)
SUZUKI RENO (05-08) 7779 D1035.

HOKC241A



KIT DE PERNOS PARA CALIPER
CHEVROLET AVEO.

HOKC242



KIT DE CALIPER RUEDA TRASERA
CHEVROLET OPTRA (06-07) 7939 D1036.

HOKC243



KIT DE CALIPER RUEDA DELANTERA Y TRASERA
CHEVROLET C4500 KODIAK (03-06), C5500 KODIAK (03-06),
GMC C5500 TOPKICK (03-06), CHEVROLET C6500 KODIAK
(03-06), C6500 TOPKICK (03-06), C7500 KODIAK (03-05),
GMC C7500 TOPKICK (03-06) 7914 D1010.

HOKC244

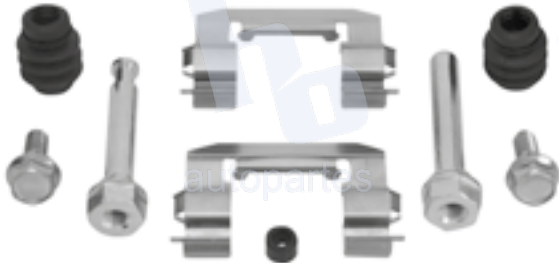

KIT DE CALIPER RUEDA DELANTERA
CHEVROLET CAPTIVA SPORT (08-15), EQUINOX (07-09),
PONTIAC TORRENT (06-08), SATURN VUE (08-10)
8381 D1264.

HOKC245

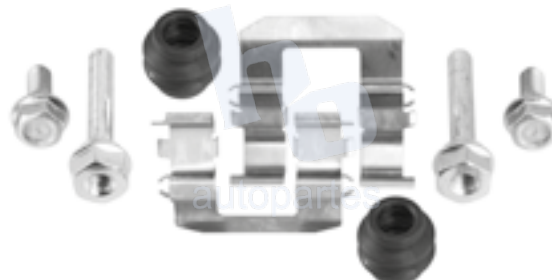

KIT DE CALIPER RUEDA TRASERA
CHEVROLET CAPTIVA (08-15), EQUINOX (07-17),
GMC TERRAIN (10-17), PONTIAC TORRENT (06-08)
8391 D1275.

HOKC246



KIT DE CALIPER RUEDA TRASERA
CHEVROLET EXPRESS 3500 (03-07) 7891 D989.

HOKC247



KIT DE CALIPER RUEDA DELANTERA
ISUZU ELF 300 (04-15), ELF 400 (04-15) 7699 D1732
ISUZU NPR (04-15) 7697 D825.

HOKC248



KIT DE CALIPER RUEDA DELANTERA
CHEVROLET AVALANCHE (07-13), CHEYENNE (13-18),
EXPRESS 1500 (09-14), CADILLAC ESCALADE (08-20),
GMC SAVANA 1500 (09-14), SIERRA (09-18), SIERRA
1500 (15-18), CHEVROLET SILVERADO 1500 (08-18),
SUBURBAN (15-20), SUBURBAN 1500 (11-14), TAHOE (08-
20), GMC YUKON (08-20) 8472 D1363

HOKC249



KIT DE CALIPER RUEDA TRASERA
CHEVROLET EXPRESS 4500 (09-17) 8523 D1465
EXPRESS PASAJEROS (09-16) 8523 D1565
FORD F450 SUPER DUTY (08-19) 8442 D1330
KIT DE CALIPER RUEDA DELANTERA Y TRASERA
CHEVROLET SILVERADO 3500 (11-18) 8523 D1411
NISSAN NV1500, NV2500, NV3500 (12-19) 8523 D1565

HOKC250

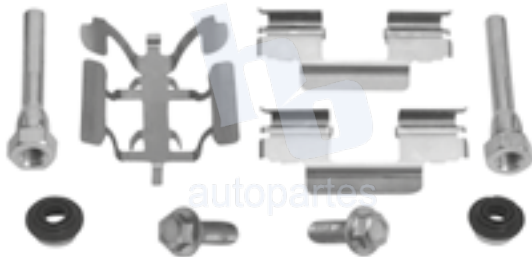

KIT DE CALIPER RUEDA TRASERA
CHEVROLET SILVERADO 1500 (99-07) 7662 D792.

HOKC251



KIT DE CALIPER RUEDA DELANTERA
BUICK LACROSE (10-16), BUICK REGAL (11-17) 8536
D1421, 8971 D1745, CHEVROLET EQUINOX (10-17),
MALIBU (13-17) 8536 D1421, GMC TERRAIN (10-15)
8536 D1421, 8971 D1745.

HOKC252



KIT DE CALIPER RUEDA DELANTERA
CHEVROLET SPARK (11-16), SPARK GT (11-16),
BEAT (18-21) 8801 D1590

HOKC253



KIT DE CALIPER RUEDA DELANTERA
CHEVROLET CRUZE (11-16) 84X0 F368, 8667 D1467,
ORLANDO (12-14) 8667 D1467, SONIC (12-18) 84X0 F368,
8730 D1522, TRAX (13-17), VOLT (11-15) 8667 D1467.

HOKC254

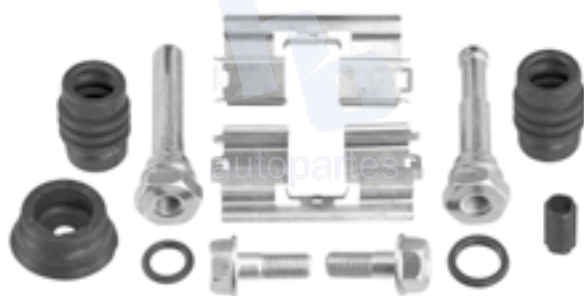

KIT DE CALIPER RUEDA TRASERA
CHEVROLET CRUZE (11-15), SONIC (12-16), TRAX (14-17),
VOLT (11-15) 8668 D1468.

HOKC255

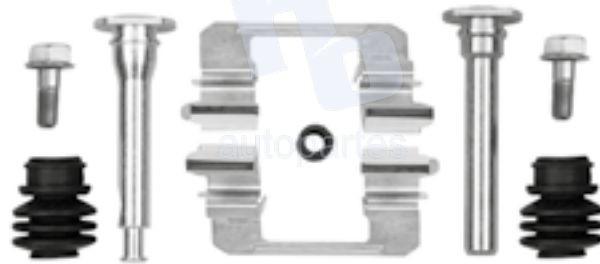

KIT DE CALIPER RUEDA DELANTERA
CHEVROLET DMAX 3.0 (11-12) 8906 D1677.

HOKC256

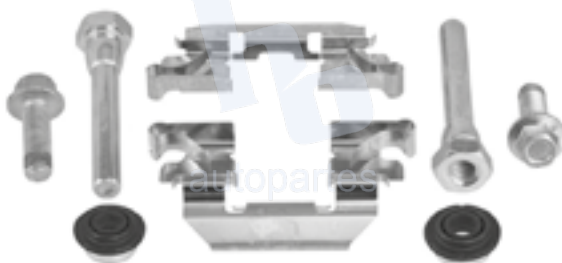

KIT DE CALIPER RUEDA TRASERA
CADILLAC ESCALADE (15-18), CHEVROLET
CHEYENNE (10-18), TAHOE (15-18), GMC SIERRA (14-18),
GMC YUKON (15-18)
 8930 D1707.

HOKC257



KIT DE CALIPER RUEDA TRASERA
CHEVROLET MALIBU 2.0 (13-15) 8547 D1430.

HOKC258



KIT DE CALIPER RUEDA TRASERA
CHEVROLET MALIBU 2.4, MALIBU 2.5 (13-15) 8547 D1430.

HOKC259



KIT DE CALIPER RUEDA DELANTERA
CHEVROLET COLORADO (14-20), GMC CANYON (15-20)
 9034 D1802.

HOKC260

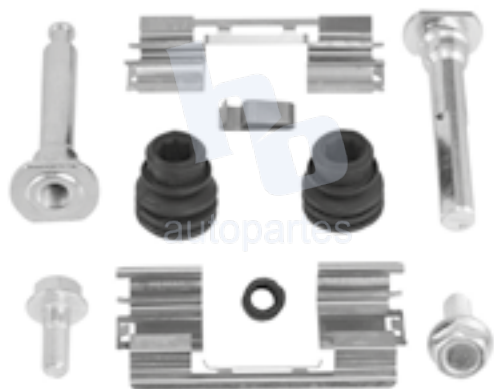

KIT DE CALIPER RUEDA TRASERA
CHEVROLET COLORADO (15-19), GMC CANYON (15-19)
 9041 D1806.

HOKC261



KIT DE CALIPER RUEDA DELANTERA Y TRASERA
CHEVROLET SIERRA 3500 HD (11-18),
SILVERADO 2500 HD (11-19) 8523 D1565,
KIT DE CALIPER RUEDA DELANTERA
GMC SIERRA 2500 (12-16) 8523 D1565.

HOKC262

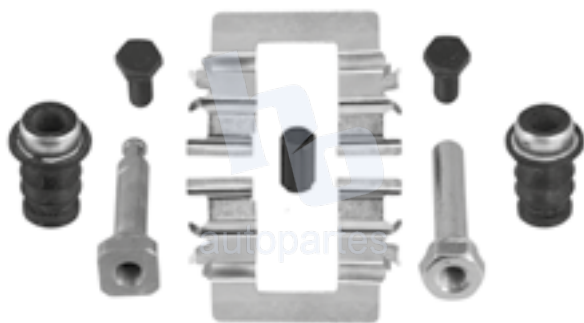

KIT DE CALIPER RUEDA DELANTERA
CHEVROLET SONIC (12-15) 8692 D1492.

HOKC263



KIT DE CALIPER RUEDA DELANTERA
CHEVROLET CRUZE (16-18), VOLT (16-17) 9072 D1844.

HOKC264

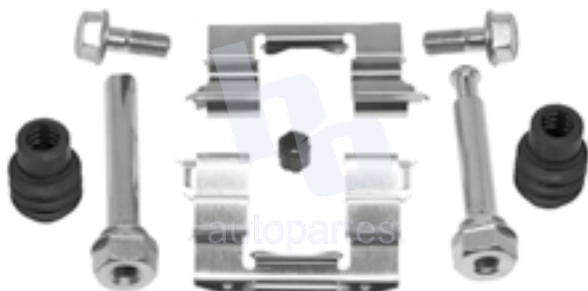

KIT DE CALIPER RUEDA DELANTERA
BUICK ENCORE (18-20) 9144 D2019, LACROSE (18-19),
CHEVROLET EQUINOX (18-20), MALIBU (17-20) 9144
D1913, TRAX (18-20) 9144 D2019, GMC TERRAIN (18-20)
9144 D1913.

HOKC265

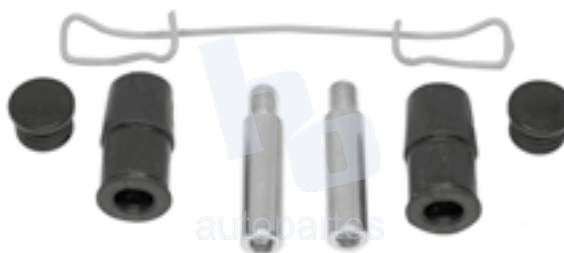

KIT DE CALIPER RUEDA DELANTERA
CHEVROLET AVEO (18-20), BEAT (19-20) 9167 D1942.

HOKC266

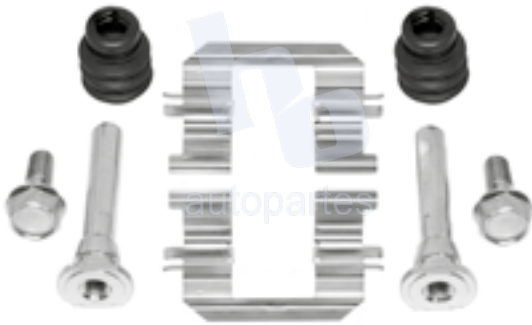

KIT PARA CALIPER RUEDA DELANTERA
CHEVROLET SPARK NG (16-20) 9083 D1684, 9254 D2024.

HOKC267

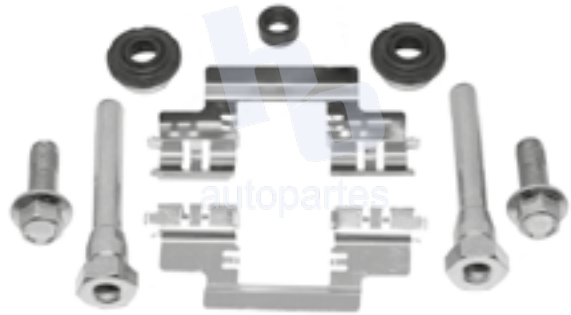

KIT PARA CALIPER RUEDA TRASERA
CADILLAC ESCALADE (18-20), CHEVROLET SILVERADO 1500 (18-19), GMC SIERRA 1500 (18-19) 8930 D1707.

HOKC268

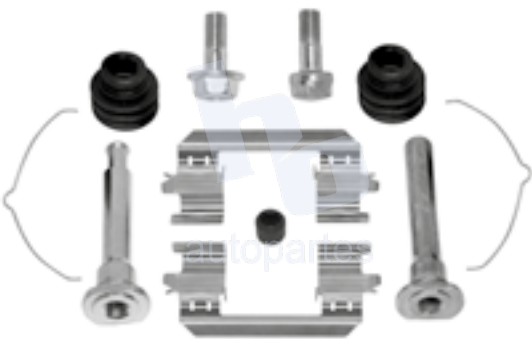

KIT PARA CALIPER RUEDA DELANTERA
CHEVROLET ACADIA (19-20), TRAVERSE (18-20), BUICK ENCLAVE (18-20), CADILLAC XT5 (19-20), CADILLAC XT6 (20-21) 9124 D1896.

HOKC269



KIT PARA CALIPER RUEDA TRASERA
CHEVROLET ACADIA (19-20), CAMARO (16-17), TRAVERSE (18-20), BUICK ENCLAVE (18-20), CADILLAC XT5 (19-20), CADILLAC XT6 (20-21). 9105 D1877.

HOKC270



KIT PARA CALIPER RUEDA TRASERA
CHEVROLET TRAX (18-20), BUICK ENCORE (18-20) 9412 D2168.

HOKC271



KIT PARA CALIPER RUEDA DELANTERA
CADILLAC ESCALADE (20-21), GMC SIERRA 1500 (19-20), CHEVROLET SILVERADO 1500 (19-21), CHEVROLET SUBURBAN (21-22), GMC TAHOE (21-22), GMC YUKON XL (21-22) 9418 D2173.

HOKC272



**KIT PARA CALIPER RUEDA TRASERA
CHEVROLET SILVERADO 1500 (19-20),
GMC SIERRA 1500 (19-20), 9419 D2174.**

HOKC273



**KIT DE CALIPER RUEDA DELANTERA CHVROLET ONIX
(20-23) 78Y1 F565, 9611 D2385.**

HOKC274

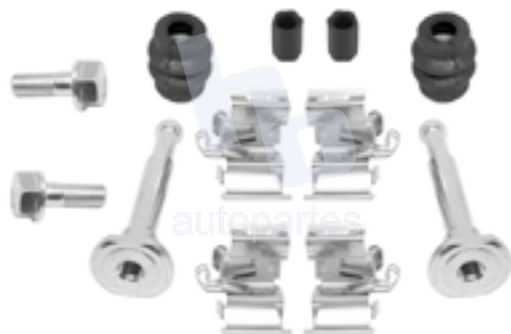

**KIT DE CALIPER RUEDA DELANTERA GM TRUCK
COLORADO (21-22) 9600 D2371, CANYON (21-22) 9600
D2371.**

HOKC275

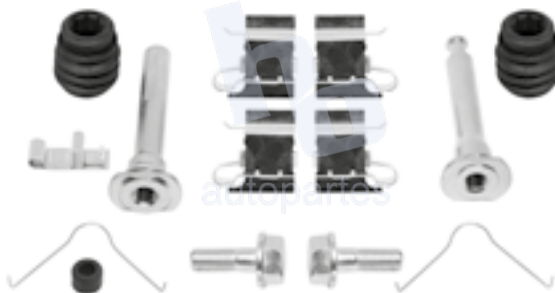

**KIT PARA CALIPER RUEDA TRASERA GM TRUCK
COLORADO (21-22) 9599 D2370, CANYON (21-22) 9599
D2370.**

HOKC276

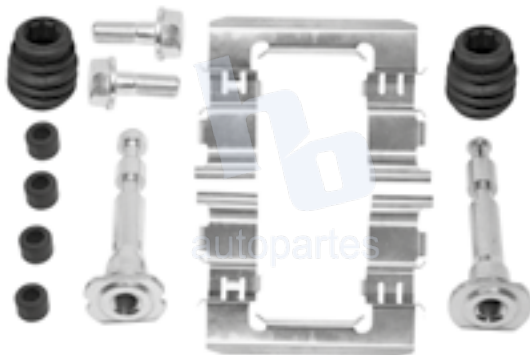

**KIT DE CALIPER RUEDA DELANTERA GM TRUCK
EQUINOX (18-21) 9114 D1886, TERRAIN (18-21) 9114 D1886,
CHEVROLET CAMARO (16-20) 9114 D1886.**

HOKC277



**KIT DE CALIPER RUEDA DELANTERA CHEVROLET
TORNADO VAN (22-23) 757Y F574.**

HOKC300

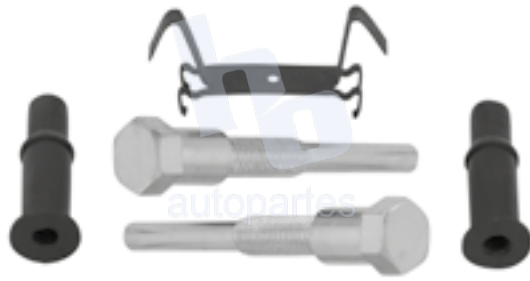

KIT DE CALIPER RUEDA DELANTERA
FORD LTD (78-86) 7082 D150, 7082 D346.
KIT DE CALIPER RUEDA TRASERA
LINCOLN TOWN CAR (92-95), FORD GRAND MARQUIS
(81-84) 7082 D150, 7082 D346.

HOKC301



KIT DE CALIPER RUEDA DELANTERA Y TRASERA
PLYMOUTH VOYAGER (84-86), DODGE DAKOTA (87-90), GRAND
CARAVAN (84-86), DODGE CARAVAN (84-86), 7258 D367, FORD
ESCORT (81-83) 7106 D179, **TAURUS (86-88)** 7222 D324, **FORD**
THUNDERBIRD (89-92) 7304 D417, **TOPAZ (84-94)** 7106 D257,
MERCURY COUGAR (89-92) 7304 D417, **SABLE (94-01)** 7308 D421,
NISSAN QUEST (93-02) 7456 D576, **VOLKSWAGEN BEETLE (99-10),**
GOLF (99-06), JETTA (99-15) 7635 D768, **VOLVO C70 (00-01), VOLVO**
S70 (98-00) 7494 D618. **AUDI A3 (99-00)** 7434 D555. **FORD CROWN**
VICTORIA (92-95), LINCOLN TOWN CAR (90-95), MERCURY GRAND
MARQUIS (94-95), FORD LTD CROWN VICTORIA (87-91) 7424 D544,
VW VIRTUS (20-23) 7709 D768

HOKC302



KIT DE CALIPER RUEDA DELANTERA
FORD THUNDERBIRD (94-98) 7479 D601
LINCOLN CONTINENTAL (97-02) 7633 D765
LINCOLN LS (00-04), LINCOLN MARK LT (93-98)
 7476 D598.

HOKC303

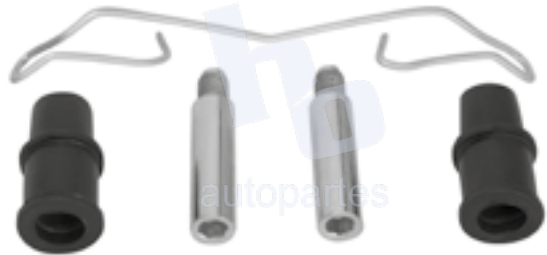

KIT DE CALIPER RUEDA DELANTERA
FORD CONTOUR (95-00) 7528 D648, 7528 D745,
 7630 D762, 7672 D801, **FOCUS (02-04), TRANSIT**
CONNECT (10-13) 7871 D970, **MERCURY MYSTIQUE**
(95-00) 7528 D648, 7528 D745, 7630 D762.

HOKC304



KIT DE CALIPER RUEDA DELANTERA
FORD TAURUS (03-05) 7633 D765, **WINDSTAR XLT (95-98)**
 7536 D656, **MERCURY SABLE (94-01)** 7633 D765.

HOKC305



KIT DE CALIPER RUEDA DELANTERA
LINCOLN TOWN CAR (95-98) 7537 D659, 7537 D678
FORD GRAND MARQUIS (96-97) 7537 D659.

HOKC306



KIT DE CALIPER RUEDA DELANTERA
FORD EXPLORER (95-04) 7532 D652, LOBO F150 (97-04),
7558 D679, RANGER (95-04), MAZDA B2300 (94-10),
B2500 (98-01), MAZDA B3000 (94-04) 7532 D652.
KIT DE CALIPER RUEDA TRASERA
FORD GRAND MARQUIS (95-03) 7617 D748.

HOKC307

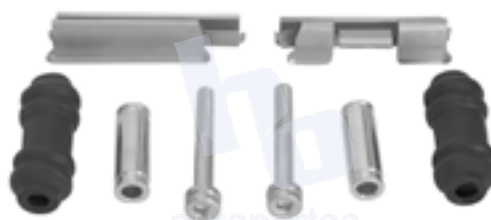

KIT DE CALIPER RUEDA DELANTERA
DODGE RAM 2500, 3500 (98-02) 7694 D821,
FORD EXPEDITION (97-02), F150 (97-99),
LINCOLN NAVIGATOR (98-02) 7576 D702.
KIT DE CALIPER RUEDA DELANTERA Y TRASERA
FORD LOBO (96-02) 7694 D821.
KIT DE CALIPER RUEDA TRASERA
FORD E200 (99-06), FORD E250 (03-06), E350 (99-06), E350
CLUB WAGON (03-05), E350 ECONOLINE (07-08), E350
ECONOLINE CLUB WAGON (99-05) 7673 D802.

HOKC308

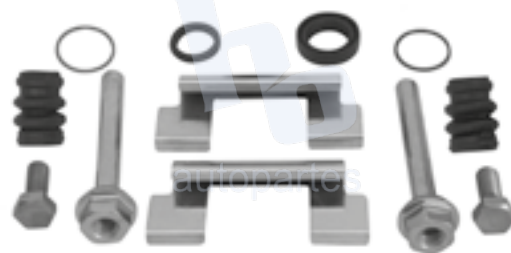

KIT DE CALIPER RUEDA TRASERA
FORD TAURUS (91-94), FORD THUNDERBIRD (89-92),
MERCURY COUGAR XR7 (90-97) 7239 D347.

HOKC309

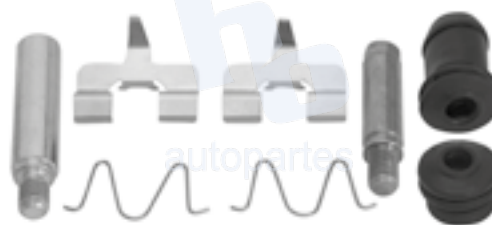

KIT DE CALIPER RUEDA TRASERA
FORD ESCORT (91-02) 7514 D663, 7338 D458,
ESCORT GL (94-00) 7514 D663, MAZDA MIATA (90-99), MX6
(94-97) 7338 D458, PROTEGE (90-97) 7514 D663.

HOKC310

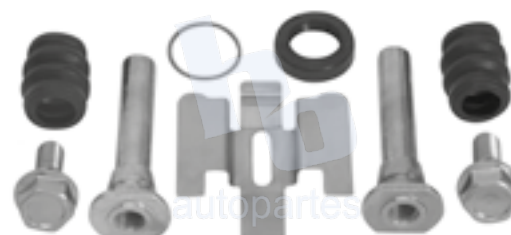

KIT DE CALIPER RUEDA TRASERA
FORD THUNDERBIRD (93-97) 7477 D599
THUNDERBIRD SC (93-97) 7477 D599, 7679 D806
LINCOLN MARK VIII (93-98), MERCURY COUGAR (93-98)
7477 D599, SABLE (94-01) 7489 D610.

HOKC311



KIT DE CALIPER RUEDA DELANTERA
FORD F250 (98-99) 7584 D711, LINCOLN NAVIGATOR (98-02)
7584 D879
KIT DE CALIPER RUEDA TRASERA
FORD LTD CROWN VICTORIA (87-91) 7610 D674,
EXPEDITION (97-02), LINCOLN NAVIGATOR (98-02),
LINCOLN TOWN CAR (99-02) 7584 D711, MERCURY
GRAND MARQUIS
(92-02) 7610 D674, FORD EXPEDITION (97-02) 7584 D879,
FORD F150 (97-03), F200 (86-91) 7584 D879, 7584 D879.

HOKC312



KIT DE CALIPER RUEDA TRASERA
FORD EXPLORER SPORT (95-05), RANGER (96-02)
 7545 D667, **WINDSTAR XLT (95-00)** 7543 D664.

HOKC313



KIT DE CALIPER RUEDA DELANTERA
FORD EXCURSION (00-05) 7625 D824, **F250 (98-00),**
F350 (98-00), F350 SUPER DUTY (99-00)
 7625 D824, 7625 D756.

HOKC314



KIT DE CALIPER RUEDA TRASERA
FORD EXCURSION (00-05), F250 (98-02), F350 (98-00),
F350 SUPER DUTY (00-05) 7626 D757.

HOKC315

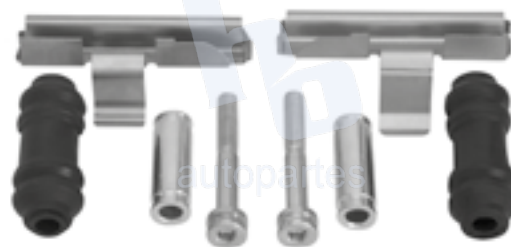

KIT DE CALIPER RUEDA DELANTERA
FORD E250 (03-07), E450 (95-00), E450 ECONOLINE
SUPER DUTY (99-02), ECONOLINE E250 (94-01), F250
(95-00), F350 (95-07) 7535 D655,

HOKC316



KIT DE CALIPER RUEDA DELANTERA
FORD WINDSTAR (99-03) 7674 D803

HOKC317

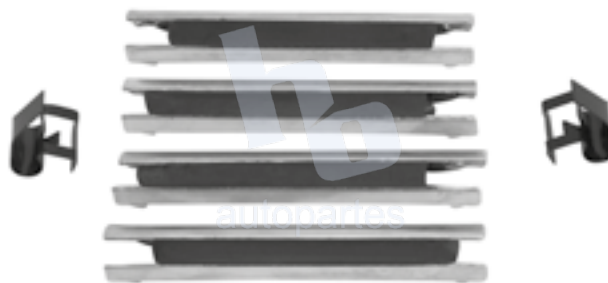

KIT DE CALIPER RUEDA DELANTERA
FORD AEROSTAR (87-96), FORD BRONCO (83-96),
EXPLORER (91-94) 7125 D387, **FORD F150 (77-86), F200**
(86-91), F250 (79-86), F350 (79-86) 7013 D50.

HOKC318



KIT DE CALIPER RUEDA DELANTERA
FORD F450 (88-07), F450 SUPER DUTY (97-98),
MIDIBUS (93-96) 7299 D411.

HOKC319



KIT DE CALIPER RUEDA DELANTERA
FORD BRONCO (94-96), E150 ECONOLINE (99-02),
F150 (94-03) 7503 D632.

HOKC320



KIT DE CALIPER RUEDA DELANTERA Y TRASERA
FORD F350 SUPER DUTY (99-06), F450 (99-09), F550
(99-09), F550 SUPER DUTY (99-09), TRITON (99-06) 7644
D777.

HOKC321

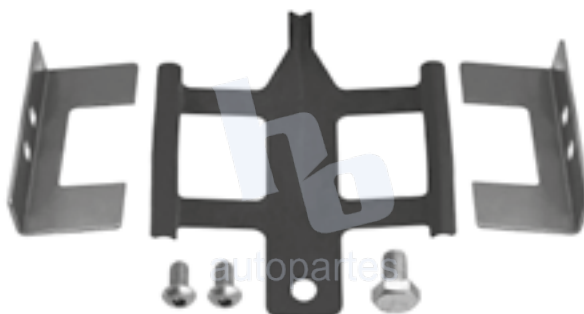

KIT DE CALIPER RUEDA DELANTERA Y TRASERA
CHEVROLET C60 KODIAK (90-96), FORD F650 (00-02)
7636 D769, 7636 D1032, GMC C6000 TOPKICK (95-96),
CHEVROLET C7500 KODIAK (00-08), FORD F550 SUPER
DUTY (05-06) 7636 D769, ISUZU FSR (99-02), FTR (04-10),
FXR (04-10) 7636 D769, 7636 D1032.

HOKC322



KIT DE CALIPER RUEDA DELANTERA
JAGUAR S-TYPE (00-06), LINCOLN LS (00-06) 7676 D805.

HOKC322A



KIT DE CALIPER RUEDA TRASERA
JAGUAR S-TYPE (00-07), LINCOLN LS (00-06) 7679 D806.

HOKC329



KIT DE CALIPER RUEDA TRASERA
FORD LTD CROWN VICTORIA (87-91) 7835 D932,
LINCOLN TOWN CAR (03-07) 7944 D1040,
FORD GRAND MARQUIS (03-07) 7835 D932.

HOKC330



KIT DE CALIPER RUEDA DELANTERA
FORD ESCAPE (01-06),
FORD MARINER (06-07) 7719 D843.

HOKC331

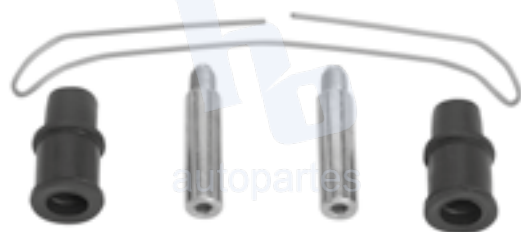

KIT DE CALIPER RUEDA DELANTERA
FORD FOCUS (00-03), FOCUS WAGON (00-03),
FOCUS ZX3 (00-03) 7690 D816.

HOKC332

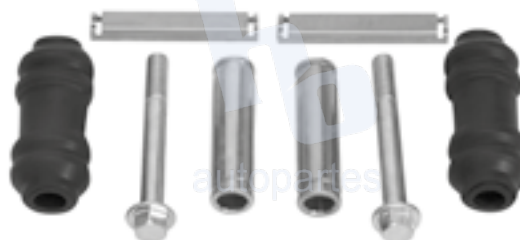

KIT DE CALIPER RUEDA DELANTERA
FORD EXPLORER (95-01) 7545 D677.
KIT DE CALIPER RUEDA TRASERA
FORD RANGER (01-04), FORD SPORT TRAC (01-04)
7545 D677 LINCOLN AVIATOR (03-05) 7851 D952.

HOKC333

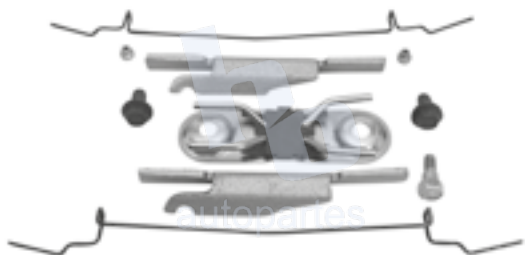

KIT DE CALIPER RUEDA DELANTERA
FORD F700 (83-97), F800 (80-97), F900 LN 700-800
(83-97), F900 LT 800-900 (83-97) 7809 D236.

HOKC334



KIT DE CALIPER RUEDA TRASERA
FORD F600 (84-89), F700 (87-97), F800 (84-97), F900 LN
700-800 (87-97), F900 LT 800-900 (87-97) 7807 D224.

HOKC335

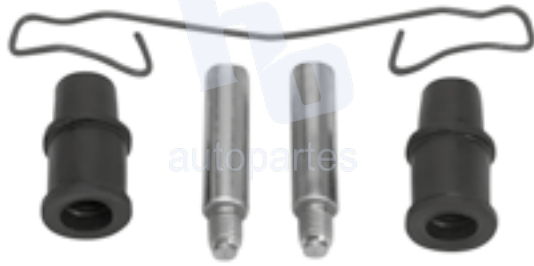

KIT DE CALIPER RUEDA DELANTERA
FORD COURIER (01-12), KA (01-08) 7529 D649, 75X6 F093,
FIESTA (98-10) 8316 D1196, 75X6 F093, **IKON (04-07)**
 75X6 F093.

HOKC336



KIT DE CALIPER RUEDA DELANTERA
FORD MONDEO (02-05) 7789 D910
KIT DE CALIPER RUEDA DELANTERA Y TRASERA
FORD MONDEO (02-05) 7790 D911.

HOKC337



KIT DE CALIPER RUEDA DELANTERA
FORD ESCAPE (04-12), FORD MARINER (05-11)
 7950 D1047.

HOKC338



KIT DE CALIPER RUEDA DELANTERA
FORD E150 ECONOLINE (99-02), E250 (04-06), 7948 D1045.

HOKC339



KIT DE CALIPER RUEDA TRASERA
FORD E150 ECONOLINE (99-02), E250 (04-06), 7949 D1046.

HOKC340



KIT DE CALIPER RUEDA DELANTERA
FORD EXPEDITION (03-06),
LINCOLN NAVIGATOR (03-06) 7837 D934.

HOKC341



KIT DE CALIPER RUEDA TRASERA
FORD EXPEDITION (03-06),
LINCOLN NAVIGATOR (03-06) 7838 D935.

HOKC342



KIT DE CALIPER RUEDA DELANTERA
FORD F150 (04-09) 7915 D1011, 7915 D1083,
FORD LOBO (04-09) 7915 D1011,
LINCOLN MARK LT (06-08) 7915 D1083.

HOKC343



KIT DE CALIPER RUEDA TRASERA
FORD F150 (04-11), LOBO (04-11),
LINCOLN MARK LT (06-08) 7916 D1012.

HOKC344



KIT DE CALIPER RUEDA TRASERA
FORD F250 SUPER DUTY (05-06), F350 (05-06) 7974 D1069.

HOKC345



KIT DE CALIPER RUEDA TRASERA
FORD F250 SUPER DUTY (05-07), F350 (05-07),
F350 SUPER DUTY (05-07) 7973 D1067.

HOKC346



KIT DE CALIPER RUEDA DELANTERA
FORD F250, F350 (05-06), F250 SUPER DUTY,
F350 SUPER DUTY (05-12), F450 SUPER DUTY (05-12)
7974 D1069.

HOKC347

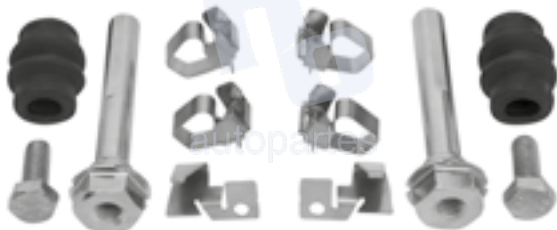

KIT DE CALIPER RUEDA TRASERA
FORD F250 SUPER DUTY, F350 (05-07) 7973 D1068.

HOKC348



KIT DE CALIPER RUEDA DELANTERA Y TRASERA
FORD F450 SUPER DUTY (08-16), F550 SUPER DUTY (02-16)
 7972 D1066.

HOKC349



KIT DE CALIPER RUEDA DELANTERA
FORD FREESTAR (04-07) 7927 D1022.

HOKC350



KIT DE CALIPER RUEDA DELANTERA
FORD FREESTAR (04-07), MONTEREY (04-06) 7926 D1021.

HOKC351

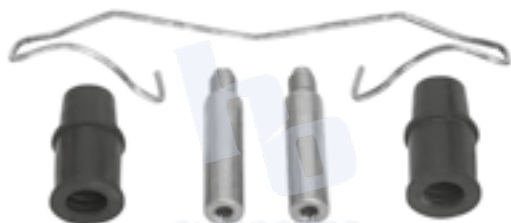

KIT DE CALIPER RUEDA DELANTERA
FORD ECOSPORT (15-21) 7947 D1044, 7947 D1563, 9270
 D1563, **ESCAPE (13-20), FOCUS (12-18) 7947 D1563**
JAGUAR S-TYPE (06-13), MAZDA 3 (04-09), SAAB 9-3X
(06-13), VOLVO C70 (06-13), S40 (04-12), V50 (05-11) 7947
 D1044.

HOKC352

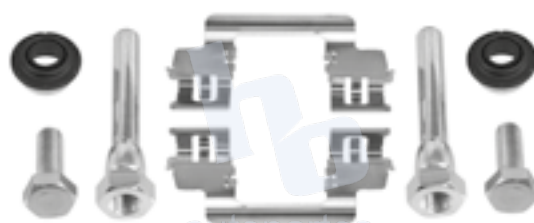

KIT DE CALIPER RUEDA DELANTERA
FORD FIVE HUNDRED (06-07), MONDEO (06-07),
TAURUS (08-09), MERCURY MONTEGO (05-07),
SABLE (94-01) 7975 D1070.

HOKC353



KIT DE CALIPER RUEDA TRASERA
FORD FIVE HUNDRED (06-07), MONDEO (06-07),
TAURUS (08-09), MERCURY MONTEGO (05-07),
SABLE (94-01) 7976 D1071.

HOKC354



KIT DE CALIPER RUEDA DELANTERA
FORD FUSION (06-09), LINCOLN MKZ (07-12),
MAZDA 6 (08-13) 8277 D1164.

HOKC355

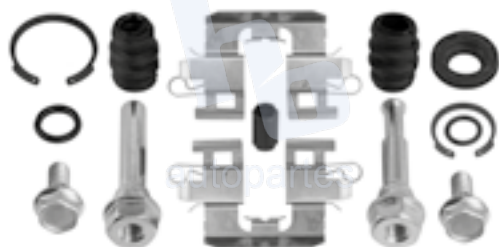

KIT DE CALIPER RUEDA TRASERA
FORD FUSION (06-09),
LINCOLN TOWN CAR (99-11) 8272 D1161.

HOKC356

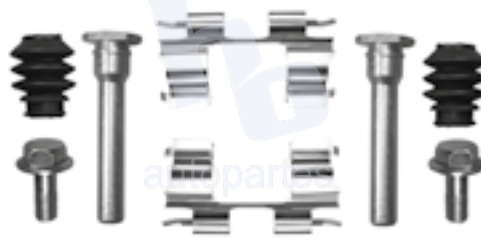

KIT DE CALIPER RUEDA DELANTERA
FORD EXPLORER SPORT TRAC (07-10)
 8268 D1158, 8715 D1508,
FLEX (11-18), TAURUS (12-18), LINCOLN MKT (12-18)
 8715 D1508

HOKC357



KIT DE CALIPER RUEDA TRASERA
FORD EXPLORER SPORT TRAC (06-09) 8214 D1109.

HOKC358

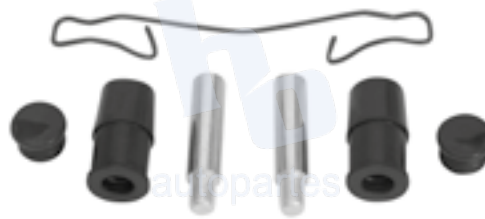

KIT DE CALIPER RUEDA DELANTERA
FORD ECOSPORT (04-12) 8289 D1175, 7Y09 F197,
IKON HATCHBACK (13-14) 7Y09 F197.

HOKC359



KIT DE CALIPER RUEDA DELANTERA
FORD EXPEDITION (07-09),
LINCOLN NAVIGATOR (07-09) 8394 D1278.

HOKC360

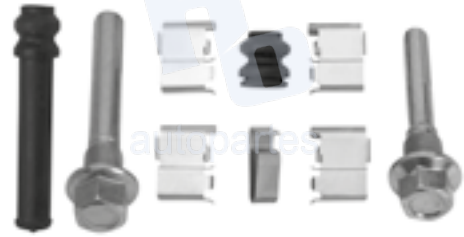

KIT DE CALIPER RUEDA DELANTERA
FORD EDGE (07-13), LINCOLN MKX (07-08),
MAZDA CX7 (07-12), CX9 (07-21) 8377 D1258.

HOKC361



KIT DE CALIPER RUEDA TRASERA
FORD EDGE (07-12), LINCOLN MKX (07-08)
MAZDA CX7 (07-12), CX9 (07-15) 8378 D1259.

HOKC362

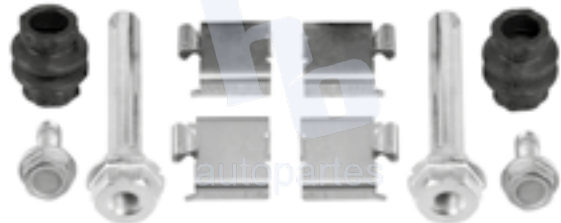

KIT DE CALIPER RUEDA DELANTERA
E150 ECONOLINE (08-14), E250 (08-14) 4440 D1328,
E350 SUPER DUTY (08-21) 4440 D1328, 8440 D1328, E450
SUPER DUTY (08-19) 4440 D1328

HOKC363



KIT DE CALIPER RUEDA TRASERA
E150 ECONOLINE (08-14) E250 (08-14), E350 SUPER
DUTY (08-19), E450 SUPER DUTY (09-19) 4441 D1329

HOKC364

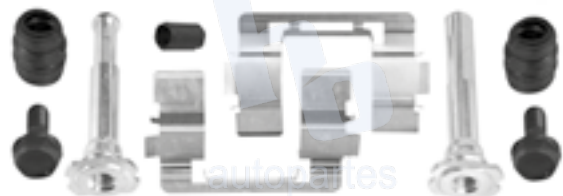

KIT DE CALIPER RUEDA DELANTERA
FORD EXPLORER, EXPLORER SPORT (03-11) 7706 D833.

HOKC365



KIT DE CALIPER RUEDA DELANTERA
F250 SUPER DUTY (08-11), F350 (08-09) 7974 D1333.

HOKC366

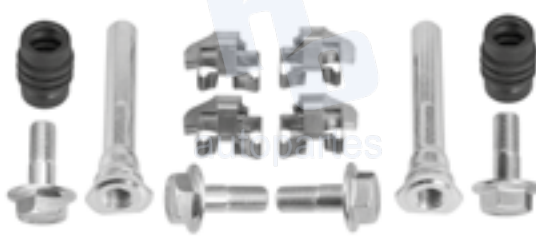

KIT DE CALIPER RUEDA TRASERA
FORD F250 SUPER DUTY (08-12), F350 (08-09),
F350 SUPER DUTY (08-12) 7973 D1334.

HOKC367



KIT DE CALIPER RUEDA DELANTERA
FORD FOCUS (08-12) 8450 D1339.

HOKC368



KIT DE CALIPER RUEDA DELANTERA
MAZDA 2 (14-19), SUZUKI BALENO (21-22) 8738 D1454
FORD FIESTA (11-19) 8653 D1454, **FIGO (16-21)** 8653 D1454,
8X53 F520, SUZUKI SWIFT (20-21) 8738 D1454,
TOYOTA YARIS (17-18) 9081 D1852.

HOKC369



KIT DE CALIPER RUEDA DELANTERA
FORD EXPEDITION (10-18), F150 (10-19) 8528 D1414, 8528
D1770, **LOBO (15-16)** 8528 D1414, **RAPTOR SVT (12-16),**
LINCOLN NAVIGATOR (12-16) 8528 D1770.

HOKC370



KIT DE CALIPER RUEDA DELANTERA
FORD F150 (10-20), LOBO (13-18),
RAPTOR SVT (13-18) 8816 D1602.

HOKC371

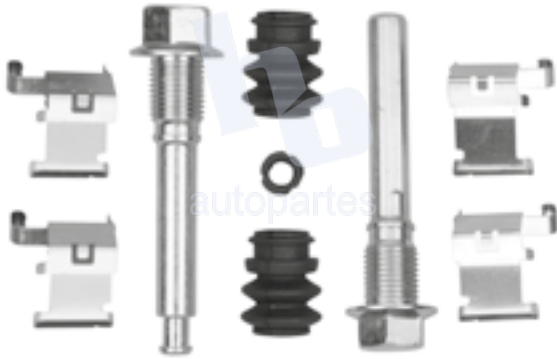

KIT DE CALIPER RUEDA DELANTERA
FORD EXPLORER (13-16) 8855 D1611, 8881 D1611,
TAURUS (14-18) 8555 D1611,
LINCOLN MKS (15-16) 8881 D1611.

HOKC372



KIT DE CALIPER RUEDA TRASERA
FORD EXPLORER (13-16), FLEX (13-14),
TAURUS (13-17), LINCOLN MKS (13-14) 8825 D1612.

HOKC373



KIT DE CALIPER RUEDA TRASERA
FORD F150 (15-16) 9018 D1790.

HOKC374

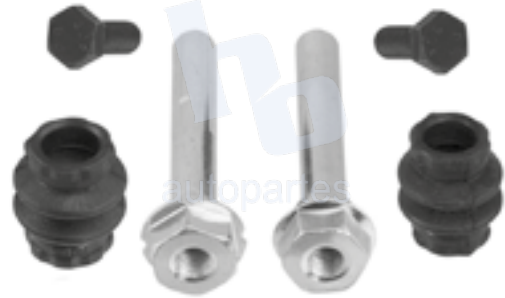

KIT DE CALIPER RUEDA DELANTERA
FORD FIESTA ST (14-16) 8954 D1730,
FIGO (16-21) 8X53 F520.

HOKC375



KIT DE CALIPER RUEDA DELANTERA
FORD ESCAPE (13-19) 8873 D1645, 8896 D1978,
FOCUS ST (15-16) 8896 D1771, **TRANSIT CONNECT**
(20-21) 8873 D1645, **LINCOLN MKC (15-17)** 8896 D1771.

HOKC376



KIT DE CALIPER RUEDA TRASERA
FORD BRONCO SPORT (21-22), LINCOLN CONTINENTAL (17-20),
CORSAIR (20-22) 8893 D1833, **FORD ECOSPORT (20-21)** 7957 D1564,
EDGE (15-22), FUSION (15-20) 8893 D1564, 8893 D1833, **ESCAPE (13-22)**
 7957 D1564, 8893 D1833, **FOCUS (12-18)** 7957 D1564, **LINCOLN MKC (15-**
19), MKX (16-18) 8893 D1564, 8893 D1833, **MKS (15-16)** 8893 D1564, **MKZ**
(15-20) 8893 D1564, 8893 D1833, **NAUTILUS (19-22), FORD SSV PLUG-IN**
HYBRID (19-20) 8893 D1833, **TRANSIT CONNECT (20-21)** 7957 D1564.

HOKC377

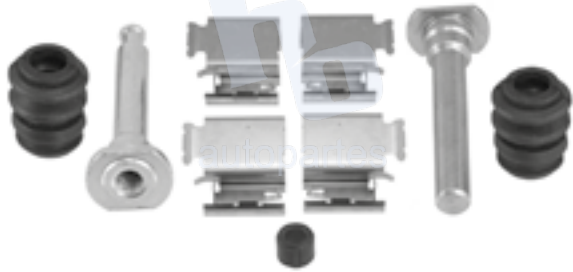

KIT DE CALIPER RUEDA DELANTERA
FORD TRANSIT 150, TRANSIT 250,
TRANSIT 350 (15-18) 9004 D1774

HOKC378

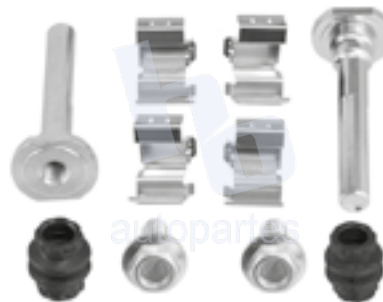

KIT DE CALIPER RUEDA TRASERA
FORD F250 SUPER DUTY (13-22) 8909 D1691, 8909 D1680
KIT DE CALIPER RUEDA DELANTERA
FORD F250 SUPER DUTY (13-20) 8909 D1680.
KIT DE CALIPER RUEDA DELANTERA Y TRASERA
FORD F350 (13-22) 8909 D1680,
FORD F450 SUPER DUTY (15-16) 8909 D1691.

HOKC379



KIT DE CALIPER RUEDA DELANTERA
BMW 323i (98-01) 7437 D558, 7649 D781, 325i (89-95), 328i
(99-00) 7437 D558, SERIE 318, 323 (99-00), 325Ci (05-06)
7649 D781, Z3 (97-02) 7437 D558, Z3 (97-98), Z4 (03-06)
7649 D781. FORD FUSION (15-20), LINCOLN MKZ (17-20)
8882 D1653, VOLVO S60 (11-18), S80 SERIES (13-15), V60
(13-15), XC70 (13-15) 8421 D1306, 318i (98-99) 7649 D781,
KIT DE CALIPER RUEDA TRASERA
LAND ROVER LR2 (09-15), LAND ROVER RANGE ROVER
EVOQUE (12-15) 8421 D1306.

HOKC380



KIT DE CALIPER RUEDA TRASERA
TRANSIT (15-18), TRANSIT 150 (15-18), TRANSIT 250
(15-18), TRANSIT 350 (15-18), TRANSIT 350 HD (15-18)
9005 D1775

HOKC381



KIT DE CALIPER RUEDA TRASERA
FORD FIESTA (15-17) 7763 D886.

HOKC382



KIT DE CALIPER RUEDA DELANTERA
FORD EDGE (15-19), LINCOLN MKX (16-18),
LINCOLN MKZ (16-20) 9053 D1818

HOKC383

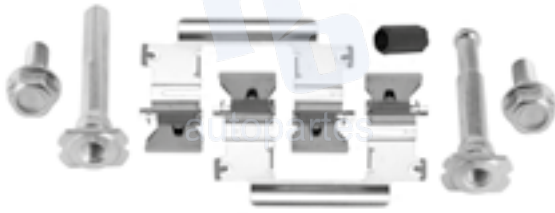

KIT DE CALIPER RUEDA DELANTERA
FORD RANGER (13-18),
MAZDA BT50 (13-18) 8905 D1676.

HOKC384



KIT PARA CALIPER RUEDA DELANTERA Y TRASERA
F450 SUPER DUTY (17-21), F550 SUPER DUTY (17-19)
 9249 D2018

HOKC385



KIT PARA CALIPER RUEDA DELANTERA
FORD F150 (18-20), EXPEDITION (18-21),
LINCOLN NAVIGATOR (18-21) 9322 D2087.

HOKC386



KIT PARA CALIPER RUEDA TRASERA
FORD RANGER (19-21) 9448 D2208.

HOKC387



KIT DE CALIPER RUEDA DELANTERA
FORD TRUCK F150 SERIES (21-22) 9610 D2382, **JEEP**
GLADIATOR (18-22) 9422 D2187, **JEEP WRANGLER (18-22)**
 9422 D2187.

HOKC388



KIT DE CALIPER RUEDA DELANTERA
FORD TRUCK BRONCO (21-22) 9456 D2216, **FORD TRUCK**
RANGER (19-22) 9456 D2216.

HOKC400

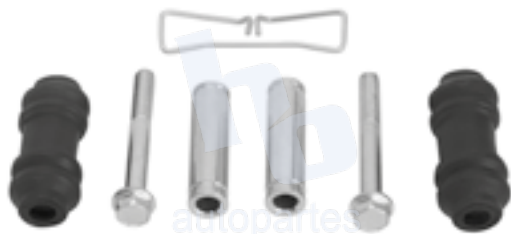

KIT DE CALIPER RUEDA DELANTERA
CHRYSLER GRAND VOYAGER (91-95),
LEBARON TURBO (92-95), LEBARON (77-95), 7404 D522,
NEW YORKER (89-94) 7406 D524, 7404 D522,
PHANTOM (90-92), DODGE SPIRIT (90-95), SPIRIT RT
RIN15 (91-94) 7404 D522, CHRYSLER TOWN & COUNTRY
(91-95), SHADOW (89-94), 7406 D524, PLYMOUTH
VOYAGER (92-95), DODGE CARAVAN (84-95) 7404 D522,
7406 D524, JEEP CHEROKEE (97-01), GRAND CHEROKEE
(97-99) 7406 D524.

HOKC401



KIT DE CALIPER RUEDA DELANTERA
PLYMOUTH VOYAGER (96-99) 7438B D641,
CHRYSLER INTREPID (98-01) 7518 D642, JEEP GRAND
CHEROKEE (97-98) 7660 D790.
KIT DE CALIPER RUEDA DELANTERA Y TRASERA
CHRYSLER CIRRUS (95-00) 7530 D650, DODGE NEON (95-97)
7518 D642, NEON RIN 13 Y 14 (95-04) 7438 D641.
KIT DE CALIPER RUEDA TRASERA
CHRYSLER CIRRUS (95-00) 7303 D512, 7438 D641, 7438B
D641, 7717 D759, NEW YORKER (88-93) 7303 D512,
PT CRUISER (01-02) 7530 D650, SHADOW (89-94) 7303 D512,
DODGE STRATUS (95-05) 7438 D641, 7530 D650,
JEEP GRAND CHEROKEE (97-98) 7502 D713.

HOKC402



KIT DE CALIPER RUEDA DELANTERA
CHRYSLER PT CRUISER (01-09) 7716 D841.

HOKC403

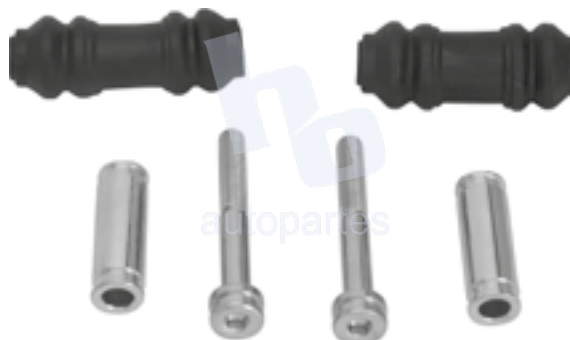

KIT DE CALIPER RUEDA DELANTERA
DODGE RAM 1500 (98-02) 7627 D758, 7694 D821
RAM 4000, RAM CHARGER (99-01) 7627 D758.

HOKC404



KIT DE CALIPER RUEDA DELANTERA
CHRYSLER 300M, CONCORDE (98-03), CHRYSLER LHS
(99-01), INTREPID (98-04), DODGE NEON (03-05) 7623 D730.

HOKC405



KIT DE CALIPER RUEDA DELANTERA
JEEP GRAND CHEROKEE (99-02) 7660 D790.

HOKC406



KIT DE CALIPER RUEDA TRASERA
JEEP CHEROKEE (99-01) 76661 D791,
MINI COOPER (02-06) 7842 D1060.

HOKC407



KIT DE CALIPER RUEDA DELANTERA
CHRYSLER GRAND VOYAGER (87-90), PLYMOUTH
VOYAGER (84-90), DODGE CARAVAN (87-90) 7164 D259

HOKC408

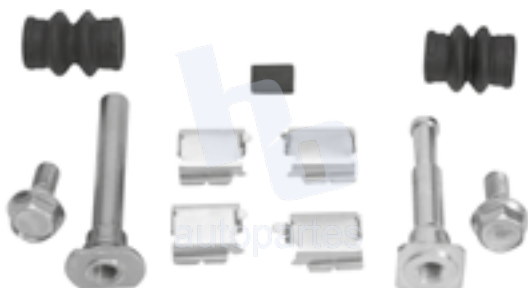

KIT DE CALIPER RUEDA DELANTERA
CHRYSLER GRAND VOYAGER (01-06),
DODGE CARAVAN RIN 15 (01-06), 7732 D856.
KIT DE CALIPER RUEDA TRASERA
JEEP LIBERTY (02-06) 7732 D856.

HOKC408A



KIT DE CALIPER RUEDA DELANTERA
CHRYSLER GRAND VOYAGER (01-02),
DODGE CARAVAN RIN 16 (01-06) 7733 D857,
KIT DE CALIPER RUEDA TRASERA
CHRYSLER TOWN & COUNTRY (01-06) 7733 D857.

HOKC409

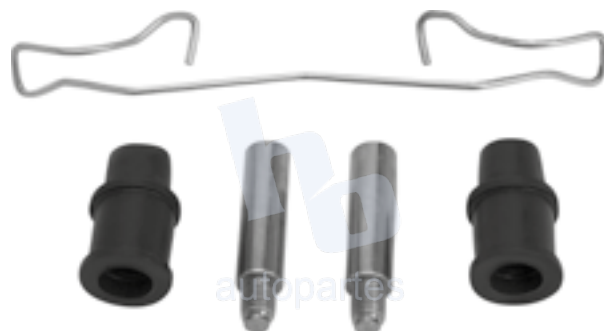

KIT DE CALIPER RUEDA TRASERA
CHRYSLER 300M (02-03), CIRRUS (01-07),
CONCORDE (98-03), SEBERING (01-07),
DODGE STRATUS (01-07) 7744 D869
KIT DE CALIPER RUEDA DELANTERA
CHRYSLER INTREPID (02-04) 7744 D869.

HOKC410



KIT DE CALIPER RUEDA DELANTERA
DODGE DAKOTA (95-02), DURANGO (98-02)
7616 D746, 7616 D820

HOKC411

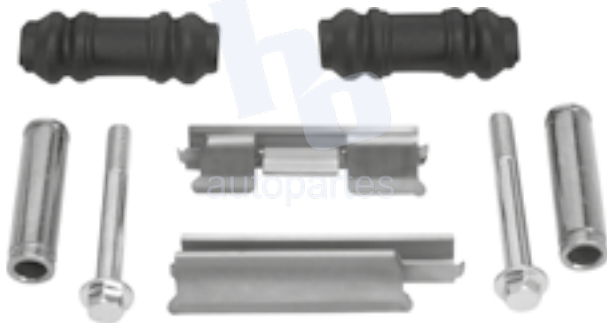

KIT DE CALIPER RUEDA DELANTERA
DODGE RAM 1500 (00-04) 7718 D842, 7774 D897,
 2500, 3500 (01-04) 7718 D842, **FORD F250, F350 (99-07)**
 7576 D702.

HOKC412



KIT DE CALIPER RUEDA DELANTERA
JEEP CHEROKEE (84-01), SERIES CJ (97-06),
WRANGLER (99-05) 7358 D712.

HOKC413

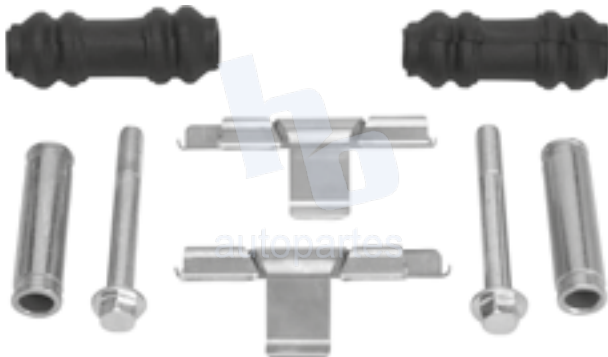

KIT DE CALIPER RUEDA TRASERA
CHRYSLER ASPEN (07-09) 7867 D967, **DODGE B1500 (02-03)**
 7775 D898, **DURANGO (02-09)** 7867 D967, **RAM 1500 (02-22),**
 7867 D967, 7775 D898

HOKC414



KIT DE CALIPER RUEDA DELANTERA
DODGE RAM 2500, 3500, 4000, 1500 (00-02) 7694 D859.

HOKC415

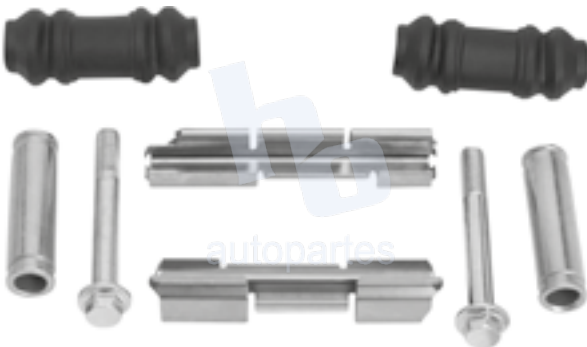

KIT DE CALIPER RUEDA TRASERA
DODGE RAM 2500 (00-05), 3500 (00-07)
 4000 (04-05), 1500 SRT10 (04-05) 7865 D1077.

HOKC416



KIT DE CALIPER RUEDA DELANTERA
DODGE RAM 4000 (00-01), RAM 1500 SRT (05-07)
RAM VAN 3500 (98-03), VAN B2500 (98-03) 7677 D655.

HOKC417

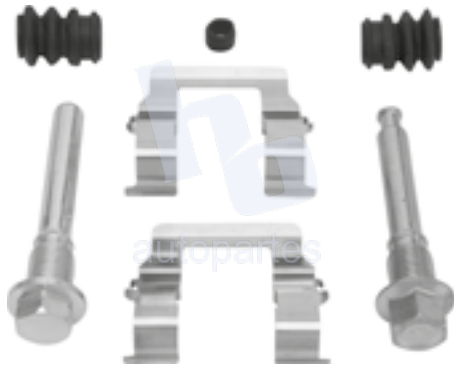

KIT DE CALIPER RUEDA TRASERA
CHRYSLER CIRRUS COUPE (00-02),
SEBERING (95-00), DODGE STRATUS (00-03) 7365 D484.
KIT DE CALIPER RUEDA DELANTERA
MITSUBISHI ECLIPSE (90-06), GALANT (90-01),
MIRAGE (90-01) 7365 D484.

HOKC418

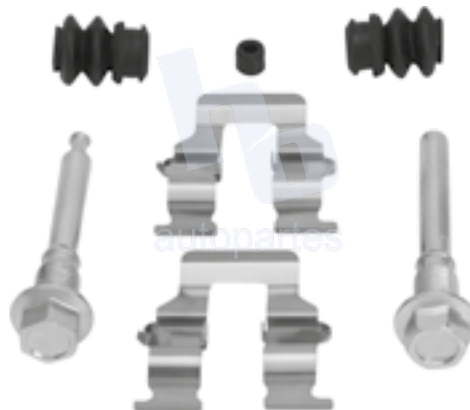

KIT DE CALIPER RUEDA TRASERA
CHRYSLER CIRRUS COUPE (00-02), SEBERING (95-00),
DODGE STRATUS (00-02) 7272 D383.

HOKC419

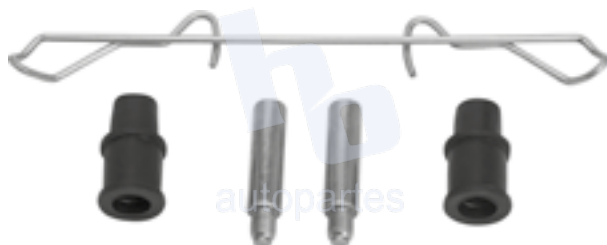

KIT DE CALIPER RUEDA DELANTERA
DODGE DAKOTA (93-98) 7410 D593.

HOKC420



KIT DE CALIPER RUEDA DELANTERA
DODGE DURANGO (03-06), RAM 1500 (03-05),
 7866 D966.

HOKC421

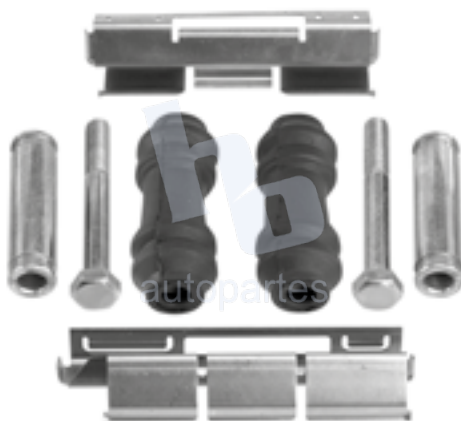

KIT DE CALIPER RUEDA DELANTERA
DODGE RAM 1500 (03-07) 7959 D1054,
RAM 2500, 3500 (03-07) 7864 D965.

HOKC422



KIT DE CALIPER RUEDA DELANTERA
JEEP GRAND CHEROKEE (02-04) 7846 D945.

HOKC423

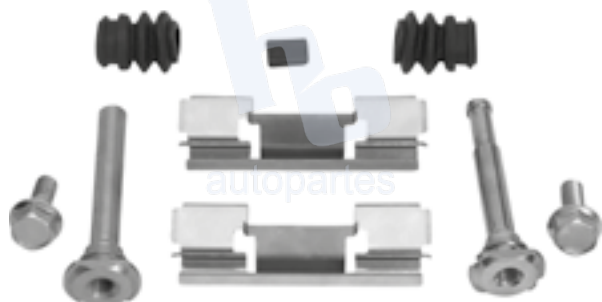

KIT DE CALIPER RUEDA DELANTERA
JEEP COMMANDER (06-07) 8297 D1181,
GRAND CHEROKEE (05-07) 7985 D1080.

HOKC424



KIT DE CALIPER RUEDA TRASERA
JEEP LIBERTY (04-07) 7863 D981.

HOKC425

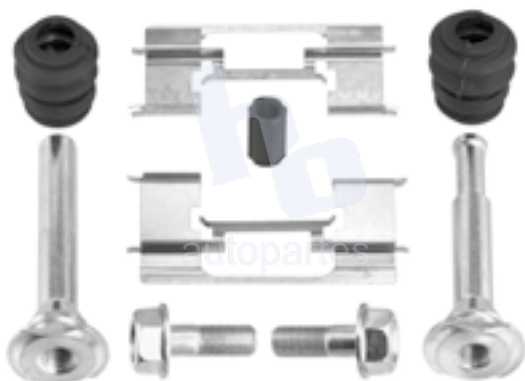

KIT DE CALIPER RUEDA DELANTERA
CHRYSLER PACIFICA (04-07) 7898 D997.

HOKC426



KIT DE CALIPER RUEDA TRASERA
CHRYSLER PACIFICA (04-07) 7899 D998.

HOKC427

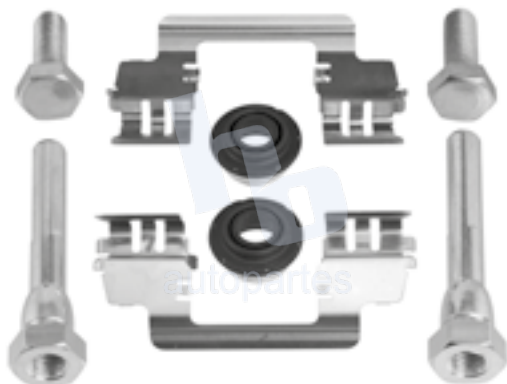

KIT DE CALIPER RUEDA DELANTERA
CHRYSLER 300 (05-18) , CHALLENGER (09-17),
DODGE CHARGER (06-22) 7962 D1056, 7965 D1058.

HOKC428

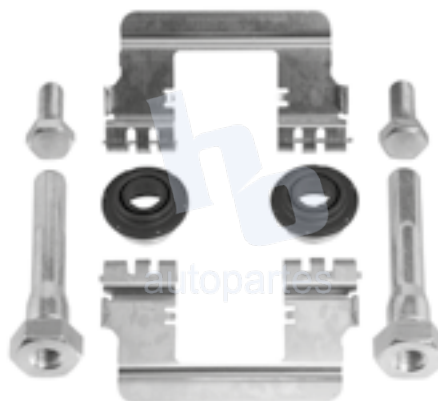

KIT DE CALIPER RUEDA TRASERA
CHRYSLER 300 (08-16), DODGE CHALLENGER (09-16),
CHARGER (06-16) 7963 D1057.

HOKC429



KIT DE CALIPER RUEDA DELANTERA
CHRYSLER CROSSFIRE (04-05) 7730 D853.

HOKC430

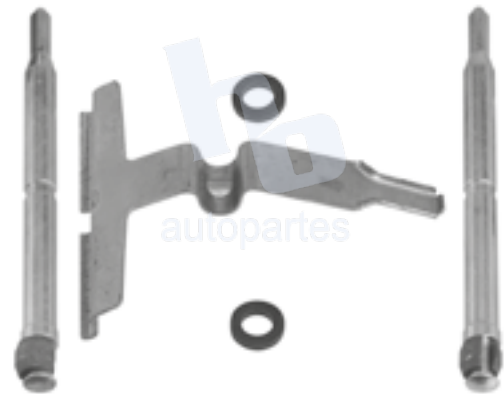

KIT DE CALIPER RUEDA TRASERA
CHRYSLER CROSSFIRE (04-05) 7647 D779.

HOKC431



KIT DE CALIPER RUEDA DELANTERA
CHRYSLER ASPEN (07-09), DODGE DAKOTA (05-10),
DURANGO (07-08), RAM 1500 PICK UP (08-21),
RAM 1500 CLASIC (20-21) 7991 D1084.

HOKC432

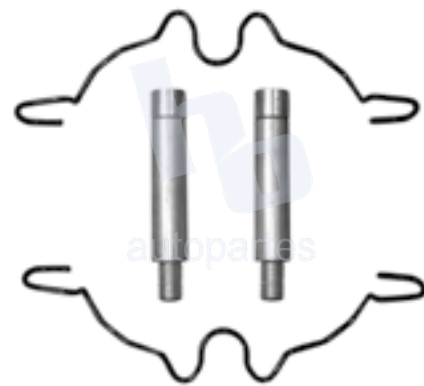

KIT DE CALIPER RUEDA DELANTERA
DODGE RAM 1500 (05-07),
RAM 1500 STR10 (05-07) 7992 D1085.

HOKC433

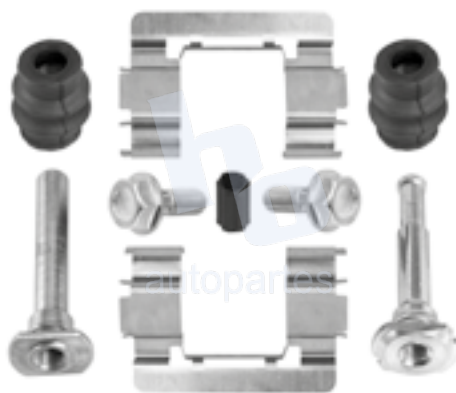

KIT DE CALIPER RUEDA DELANTERA
DODGE DAKOTA (03-04) 7861 D962.

HOKC434



KIT DE CALIPER RUEDA TRASERA
DODGE DAKOTA (03-04) 7862 D963.

*Ø. = DIÁMETRO EXTERIOR *h. = ALTURA*
 * TODOS LOS PISTONES INCLUYEN LIGA Y SILICÓN

HOKC435

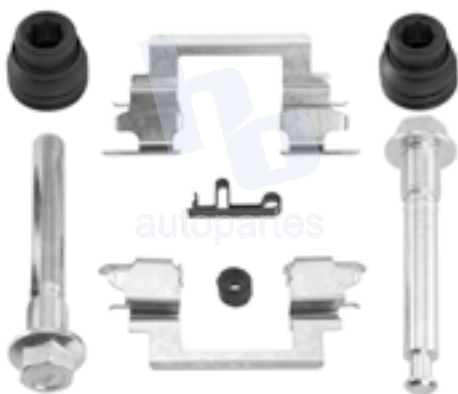

KIT DE CALIPER RUEDA DELANTERA
DODGE AVENGER (08-12) 7741 D866, **CALIBER (07-12)** 8338 D866, **JEEP COMPASS (07-10), PATRIOT (07-10)** 7741 D866.

HOKC436

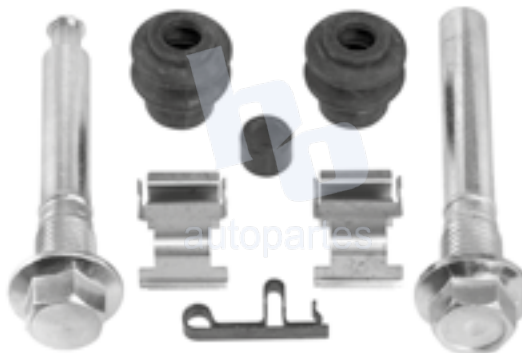

KIT DE CALIPER RUEDA TRASERA
CHRYSLER 200 (11-14), SEBERING (07-10), DODGE AVENGER (08-14), CALIBER (07-12), JEEP COMPASS (07-18), PATRIOT (07-17), MITSUBISHI LANCER (04-14), OUTLANDER (05-10) 7940 D1037, 7743 D868, **MONTERO (01-08)** 7743 D868.

HOKC438



KIT DE CALIPER RUEDA TRASERA
JEEP COMMANDER (06-09), GRAND CHEROKEE (06-09) 7945 D1087.

HOKC439



KIT DE CALIPER RUEDA DELANTERA
DODGE ATTITUDE (06-07), HYUNDAI ACCENT (06-09), KIA RIO (06-09) 8266 D1156.

HOKC440



KIT DE CALIPER RUEDA DELANTERA
CHRYSLER TOWN & COUNTRY (08-15), DODGE GRAND CARAVAN (08-16), JOURNEY (10-13), RAM CARGO VAN (14-15) 8703 D1327, **DODGE NITRO (07-12), JEEP LIBERTY (08-14), WRANGLER (07-17)** 8389 D1273. **JEEP SERIES CJ (07-15), VOLKSWAGEN ROUTAN (09-14)** 8703 D1327.

HOKC441



KIT DE CALIPER RUEDA TRASERA
DODGE NITRO (07-12), JEEP LIBERTY (08-12), JEEP SERIES CJ (13-15), WRANGLER (07-15) 8390 D1274.

HOKC442

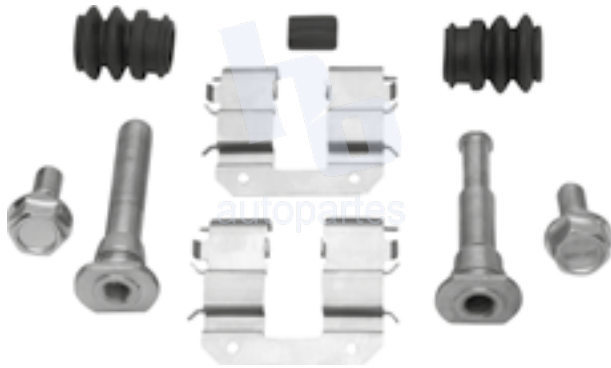

KIT DE CALIPER RUEDA DELANTERA
DODGE ATTITUDE (06-10) 8267 D1157.
KIT DE CALIPER RUEDA TRASERA
HYUNDAI ACCENT, KIA RIO (06-10) 8267 D1157.

HOKC443

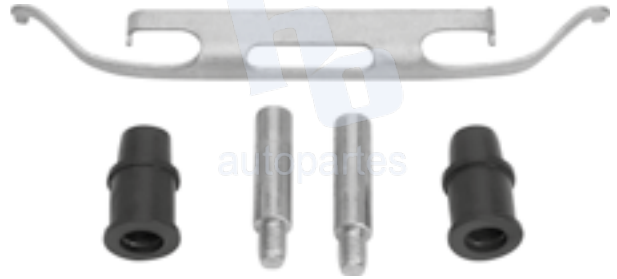

KIT DE CALIPER RUEDA DELANTERA
CHRYSLER CROSSFIRE (05-06), MERCEDES BENZ
E500 (04-05), MERCEDES BENZ SLK32 (03-04) 7561 D682.

HOKC444



KIT DE CALIPER RUEDA TRASERA
CHRYSLER TOWN & COUNTRY (08-12)
DODGE JOURNEY (10-12) 8438 D1326,
FORD EXPLORER (13-16), FLEX (09-17) 8488 D1377,
VOLKSWAGEN ROUTAN (09-14) 8438 D1326.
KIT DE CALIPER RUEDA DELANTERA
DODGE GRAND CARAVAN (08-12) 8438 D1326.

HOKC445



KIT DE CALIPER RUEDA DELANTERA
DODGE RAM 2500 (09-18), 3500 (09-10) 8507 D1399.

HOKC446

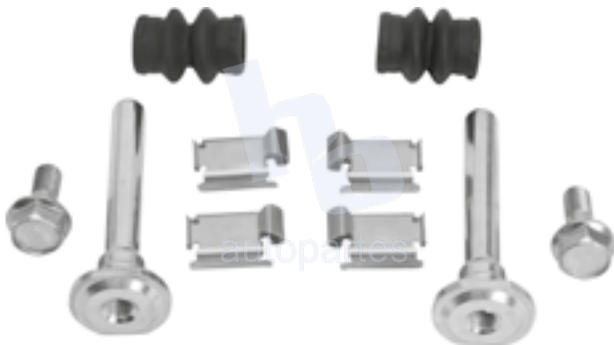

KIT DE CALIPER RUEDA TRASERA
DODGE RAM 2500 (09-18), 3500 (11-18) 8508 D1400.

HOKC447



KIT DE CALIPER RUEDA DELANTERA
DODGE DURANGO (11-20) 8655 D1455, 8856 D1904, JEEP
GRAND CHEROKEE (09-18) 8655 D1455, 8656 D1629, 8856
D1904, GRAND CHEROKEE 3.6L, 5.7L (19-20) 8856 D1904,
MERCEDES BENZ ML350 (12-15) 8656 D1629.

HOKC448



KIT DE CALIPER RUEDA TRASERA
DODGE DURANGO (11-14),
JEEP GRAND CHEROKEE (08-16) 8698 D1498.

HOKC449



KIT DE CALIPER RUEDA DELANTERA
DODGE ATTITUDE, HYUNDAI ACCENT (06-11),
KIA RIO (06-11) 8266 D1156.

HOKC450



KIT DE CALIPER RUEDA DELANTERA
DODGE ATTITUDE (12-14) 8806 D1593, 8X51 F386,
HYUNDAI ACCENT (12-17), KIA RIO (12-17) 8806 D1593.

HOKC452



KIT DE CALIPER RUEDA DELANTERA Y TRASERA
CHRYSLER TOWN & COUNTRY (12-16), DODGE GRAND
CARAVAN, JOURNEY (12-18), RAM CARGO VAN (13-16),
VOLKSWAGEN ROUTAN (12-14) 8811 D1596.

HOKC453



KIT DE CALIPER RUEDA DELANTERA
DODGE DART (13-16), JEEP CHEROKEE (14-18) 8867 D1640.

HOKC454



KIT DE CALIPER RUEDA TRASERA
DODGE DART (13-14) 8875 D1647.